



• General Bearings •

NEEDLE ROLLER BEARINGS



JTEKT

JTEKT CORPORATION

CAT. NO. B2003E

Technical section

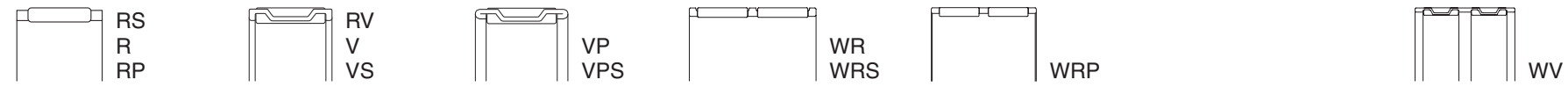

Needle roller and cage assemblies



Needle roller and cage assemblies for use with connecting rods

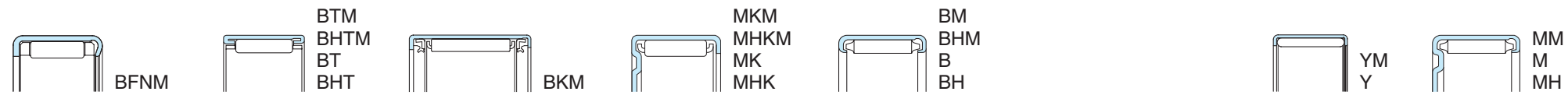

Drawn cup needle roller bearings

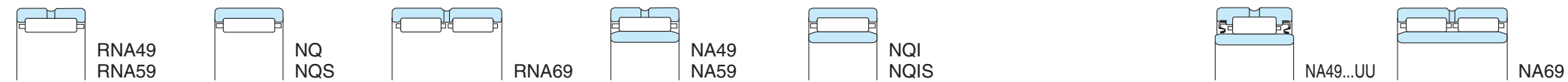

Machined ring needle roller bearings



Inner rings for needle roller bearings

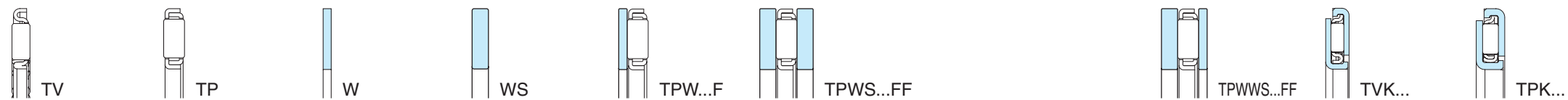

Needle roller thrust bearings

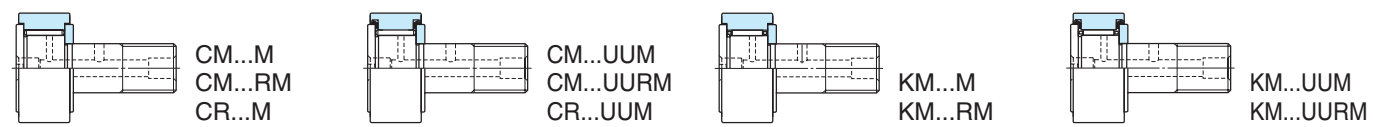

Stud type track rollers (cam followers)

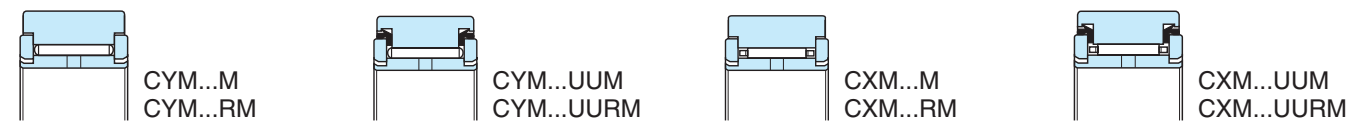

Yoke type track rollers (roller followers)

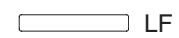

Needle rollers

Other products · Example of use

Supplementary tables



NEEDLE ROLLER BEARINGS

CAT. NO. B2003E

Value & Technology

Publication of New **Koyo** Needle Roller Bearing Catalog

We are pleased to offer our new Koyo Needle Roller Bearing catalog to you.

Needle roller bearings are being used in a wide range of machinery, such as automobiles, motor cycles, electric machines, aerospace equipment, machine tools, office and hydraulic equipment, and other general industrial machinery. In every field, new products are developed for saving of energy and conservation of environment, and needle roller bearings play a part in it.

This thoroughly-revised catalogue includes the latest bearing types, models, and technical information.

We trust this catalog will help you to select and use needle roller bearings appropriately. We are grateful for your patronage and look forward to continuing to serve you in the future.

★The contents of this catalog are subject to change without prior notice. Every possible effort has been made to ensure that the data herein is correct; however, JTEKT cannot assume responsibility for any errors or omissions.

Reproduction of this catalog without written consent is strictly prohibited

Contents

Technical section

1 Characteristics and types of needle roller bearings		8 Lubrication and sealing devices	
1.1 Characteristics of needle roller bearings ...	7	8.1 Purpose of lubrication	21
1.2 Characteristics of varied needle roller bearing types	7	8.2 Lubricant	21
1.3 Types of needle roller bearing	8	8.3 Grease lubrication	21
2 Outline of bearing selection	10	8.4 Replenishment/replacement of grease	23
3 Bearing service life and load rating		8.5 Oil lubrication	23
3.1 Bearing service life	11	8.6 Oil lubrication method	24
3.2 Calculation of service life	11	8.7 Sealing devices	25
3.3 Basic rating life	11	9 Handling of bearings	
3.4 Corrected rating life	11	9.1 General instructions	29
3.5 Correction of basic dynamic load rating	12	9.2 Bearing mounting	29
3.6 Basic static load rating	13	9.3 Force is necessary to press fit and remove bearings	30
3.7 Applications and recommended bearing service life	13	9.4 Test run	30
4 Bearing load		9.5 Bearing dismounting	31
4.1 Dynamic equivalent load	14	9.6 Cleaning	31
4.2 Static equivalent load	14	10 Examples of bearing failures	32
4.3 Load Applied to the Bearing	14		
4.4 Mean dynamic equivalent load	15		
4.5 Limiting speed	16		
5 Shaft and housing			
5.1 Accuracy and roughness	17		
5.2 Material	17		
5.3 Mounting Dimensions	17		
6 Fits			
6.1 Fit selection	18		
6.2 Recommended Fits	19		
7 Clearance	20		

Specification tables

11 Specification tables of needle roller bearings

1 Needle roller and cage assemblies	40
Single-row	44
Double-row	58
Needle roller and cage assemblies for use with connecting rods	60
For large ends	62
For small ends	66
2 Drawn cup needle roller bearings	68
Metric series	76
Inch series	98
3 Machined ring needle roller bearings	116
Inner rings for needle roller bearings	139
4 Needle roller thrust bearings	144
5 Track rollers	
Stud type track rollers (cam followers)	158
CM (metric series, full complement type)	162
CR (inch series, full complement type)	164
KM (metric series, caged type)	168
Yoke type track rollers (roller followers)	170
CYM (full complement type)	172
CXM (caged type)	174
6 Needle rollers	176

Other products · Example of use · Supplementary tables

12 Other products

Needle roller and cage assemblies for high-rotation speed planetary gears	182
Low torque needle roller and cage thrust assemblies ...	183
Rocker Roller (bearing for roller rocker arm) ...	184

13 Example of use

Motorcycle, Engine	185
Front Wheel Drive Mini-Vehicles, Transmission ...	185
Front Wheel Drive Passenger Car, Transmission ...	186
Rear Wheel Drive Passenger Car, Transmission ...	186
Passenger Car, Steering Gear (Sector Shaft) ...	187
Passenger Car, Front Suspension (Shock Absorber) ...	187
Passenger Car, Valve Lifter	188
Alternator	188
Cultivator, Transmisson	188
Planetary Gear Reducer	189
Swash Plate Pump	189
Gear Pump	190
Power Shovel, Wheel Drum	190
Hoist	191
Overhead Crane (1)	191
Overhead Crane (2)	192
Forklift Truck, King Pin	192
Multivane Rotary Compressor	192
Shutter Driving Gear	193
Machine Tool, Bed	193
Grinder Hoist	193
Torque converter	194

14 Supplementary tables

1 Shaft tolerances (deviation from nominal dimensions)	196
2 Housing bore tolerances (deviation from nominal dimensions)	198
3 SI units and conversion factors	200
4 Steel hardness conversion	204
5 Viscosity conversion	205
6 °C/°F conversion	206
7 Inch/millimeter conversion	207

1 Characteristics and types of needle roller bearings

1.1 Characteristics of needle roller bearings

1 Large Load Rating

As compared with general ball and roller bearings, the Koyo needle roller bearings can ensure a large load rating in a small space, and can be used without inner rings or needle roller and cage assemblies so that the whole of the machine can be reduced in size and weight, thus making the design around the bearing more compact.

2 Small Cross-sectional Height

Due to its small cross-sectional height, the bearing can fit in nearly the same space as the conventional plain bearing. In addition, handling and maintenance are very easy.

3 Withstanding High-Speed Operation

Compared with general ball and roller bearings, this bearing is smaller in pitch circle diameter. As a result, a temperature rise has little influence on the load and rotating speed, making it advantageous in high-speed operation.

4 Many Rollers

The load is uniformly applied to the rollers, thus ensuring a greater loading capacity. In addition, use of many rollers with small diameters makes the bearing advantageous in oscillating rotation.

1.2 Characteristics of varied needle roller bearing types

• Needle roller and cage radial assembly

It comprises needle rollers and cage, and the shaft and housing of appropriate tolerance and hardness are used as bearing ring.

• Needle roller and cage radial assembly for connecting rod

This highly strong needle roller and cage assembly is used for engine connecting rods in motor cycles and outboard motor.

• Drawn cup needle roller bearing

This bearing, comprising outer ring made of high-quality cold rolled steel strips and needle rollers, is press-fitted into the housing. It comes in two types of full complement type and cage included type. Each of them comes in two outer ring types, open ends type and closed end type.

• Machined ring needle roller bearing

This bearing comprises outer ring made of good-quality high carbon chromium bearing steel, and needle roller and cage incorporated in it. It comes in two types, no inner ring type and inner ring included type.

• Needle roller thrust bearing











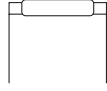
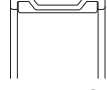

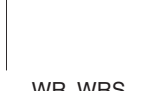

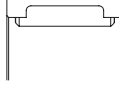
This bearing, being able to carry axial load, comprises needle roller and cage thrust assembly, and a thrust race, can be matched with a pressed thin race or machined thick race. It comes in two types of separable type in which thrust race and needle roller and cage thrust assembly are to be combined at use and non-separable type in which they are assembled.

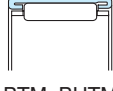
• Track roller

This bearing, incorporating needle rollers in thick outer ring, comes in two types of stud type and yoke type. For each of them, full complement type, cage or seal included type, and many other types are available depending on applications.

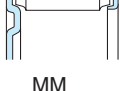

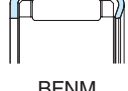
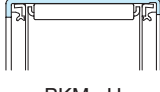
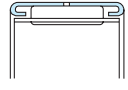
1 Characteristics and types of needle roller bearings

1.3 Types of needle roller bearing

		Needle roller and cage assemblies		Drawn cup needle roller bearings		
		For general use	For use with connecting rods	With cage	Full complement type	
Basic type		 RS, R, RP  RV, V, VS  VP, VPS  WR, WRS  WRP  WV	<ul style="list-style-type: none"> For use at large end (for crank pin)  BE  VE, VS...P For use at small end (for piston pin)  RE R...P UR...P 	<ul style="list-style-type: none"> Open ends type  BTM, BHTM BT, BHT Closed end type  MKM, MHKM MK, MHK 	<ul style="list-style-type: none"> Open ends type  BM, BHM B, BH  YM Y Closed end type  MM M, MH 	
	Other-types	<ul style="list-style-type: none"> With synthetic resin  RFN With double split cage RU, VU, VPU RFNU (with synthetic resin) 		<ul style="list-style-type: none"> With synthetic resin  BFNM Sealed type  BKM...U With lubrication hole  BTM...OH 	<ul style="list-style-type: none"> Miniature one-way clutch*  1WC, EWC For universal joint*  YM 	
Characteristics	Load Capacity (Radial)	Large	Large	Medium	Large	
	Load Capacity (Axial)	–	–	–	–	
	Limiting speeds	High	High	High	Medium	
	Cylindricity ¹⁾	Medium	Medium	Medium	Low	
	Cross-sectional height	Low	Low	Low	Low	
Reference pages of		P44 – 59	P62 – 67	P76 – 115		

[Remark] Contact JTEKT if you need bearings with *-marks.

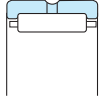
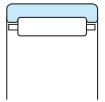
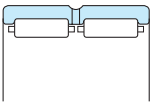
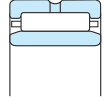
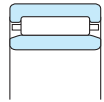
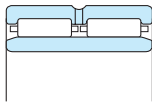
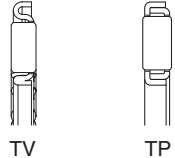
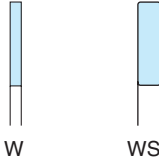
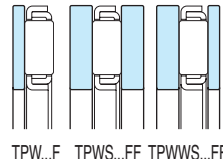
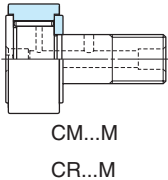
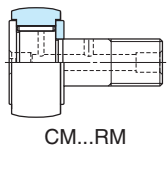
[Note] 1) For needle roller thrust bearings, it means squareness.

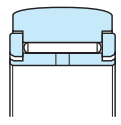
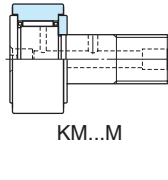
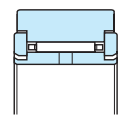
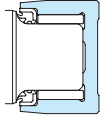
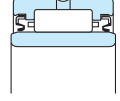
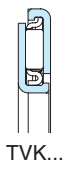
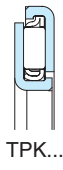
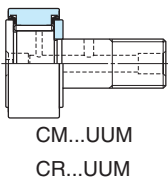
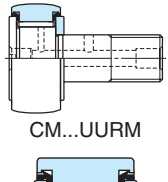
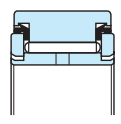
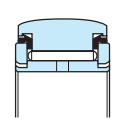
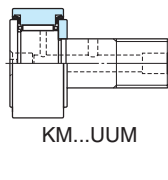
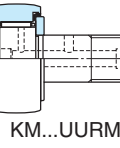
	Machined ring needle roller bearings		Needle roller thrust bearings	Track rollers	
	Without inner ring	With inner ring		Full complement type	With cage
	 <p>RNA49 RNA59</p>  <p>NQ NQS</p>  <p>RNA69</p>	 <p>NA49 NA59</p>  <p>NQI NQIS</p>  <p>NA69</p>	<ul style="list-style-type: none"> Needle roller and cage assembly  <p>TV TP</p> Race  <p>W WS</p> Combination type (separable type)  <p>TPW...F TPWS...FF TPWWS...FF</p> 	<ul style="list-style-type: none"> Stud type (cam followers)  <p>CM...M CR...M</p>  <p>CM...RM KM...RM</p> Yoke type (roller followers)  <p>CYM...M CYM...RM</p>  <p>CXM...M CXM...RM</p> 	<ul style="list-style-type: none"> Stud type (cam followers)  <p>KM...M KM...RM</p> Yoke type (roller followers)  <p>CXM...M CXM...RM</p>
<ul style="list-style-type: none"> With locating snap ring (outer ring) With pin hole (outer ring) Double split type for crank shaft For universal joint*  <p>KC</p> <ul style="list-style-type: none"> With dimple for universal joint* 	<ul style="list-style-type: none"> With locating snap ring (outer ring) With pin hole (outer ring) Sealed type  <p>NA49...UU</p> <ul style="list-style-type: none"> Heavy duty series* (Bearings conforming to ISO 6979) 	<ul style="list-style-type: none"> Non-separable  <p>TVK...</p>  <p>TPK...</p>	<ul style="list-style-type: none"> Sealed type  <p>CM...UUM CR...UUM</p>  <p>CM...UURM KM...UURM</p>  <p>CYM...UUM CYM...UURM</p>  <p>CXM...UUM CXM...UURM</p>	<ul style="list-style-type: none"> Sealed type  <p>KM...UUM KM...UURM</p>  <p>CXM...UUM CXM...UURM</p>	
Large	Large	–	Large	Large	Medium
–	–	–	–	–	–
High	High	High	High	Low	High
Medium	Medium	Low	Low	Low	Medium
Medium	Medium	Low	Low	Medium	Medium
P122 – 137		P148 – 157		P162 – 169, P172 – 175	

2 Outline of bearing selection

Currently, as design of needle roller bearings has become diversified, their application range is being increasingly extended. In order to select the most suitable bearings for an application, it is necessary to conduct a comprehensive study on both bearings and the equipment in which the bearings will be installed, including operating conditions, the performance required of the bearings, specifications of the other components to be installed along with the bearings, marketability, and cost performance, etc.

In selecting needle roller bearings, since the bearing installation space is usually determined beforehand, the

bearing type and dimensions are chosen based upon the machine operating conditions, according to the bearing installation space.

Internal specifications including bearing tolerance, internal clearance, and lubricant are also selected, depending on the application.

For reference, general selection procedure and operating conditions are described in **Table 2.1**. There is no need to follow a specific order, since the goal is to select the right bearing to achieve optimum performance.

Table 2.1 Bearing selection procedures

	Operating conditions to be considered	Reference page No.
(1) Bearing type ↓	<ul style="list-style-type: none"> • Installation space • Load magnitude, types and direction of application • Rotational speed • Running accuracy • Inclination of inner ring and outer ring (Misalignment) • Mounting ease 	P8
(2) Bearing dimension ↓	<ul style="list-style-type: none"> • Specifications for installation • Recommended service life • Dynamic equivalent load • Static equivalent load • Rotational speed • Bearing boundary dimensions • Basic dynamic load rating • Basic static load rating 	P13 P14 P14 Refer to "Specification tables of needle roller bearings" P11 P13
(3) Fit and internal clearance ↓	<ul style="list-style-type: none"> • Load magnitude, types • Operational temperature distribution • Materials, size and tolerances of shaft and housing • Fit • Difference in temperature of inner and outer rings • Rotational speed • Bearing tolerances • Clearance 	P17 P18 P19 Refer to "Specification tables of needle roller bearings" P20
(4) Lubrication, lubricant, sealing device ↓	<ul style="list-style-type: none"> • Operating temperature • Rotational speed • Lubrication • Lubricant • Sealing device • Limiting speed • Replenishment/replacement of grease 	P24 P21 P25 P16 P23
(5) Mounting and dismounting ↓	<ul style="list-style-type: none"> • Mounting and dismounting • Mounting dimensions 	P29, 31 P17

Final determination of bearing and associated aspect

3 Bearing service life and load rating

3.1 Bearing service life

Even if rolling bearings are rotated under ideal conditions, contact stress is continuously and repeatedly applied to the raceway surfaces of inner and outer rings or rolling contact surfaces of rolling elements, and material flakes from the raceway surfaces and rolling contact surfaces due to fatigue of material. The total number of bearing rotations (or total operating period at a constant speed) until flaking occurs is regarded as the bearing service life.

Even if bearings of the same dimensions, structure, material, and processing method are operated under the same rotating conditions, their service lives are considerably varied.

Since this phenomenon results from fatigue distribution in bearing materials themselves, differences in bearing service life should be statistically considered. When a group of identical bearings are rotated under the same conditions, the total number of revolutions until 90 % of the bearings are left without flaking (i.e. a service life of 90 % reliability) is defined as the basic rating life. Or in operating at a constant speed, it can be expressed by the total number of bearing rotations.

In practical service, however, a bearing fails not only because of fatigue, but other coefficients as well, such as wear, seizure, creep, fretting, brinelling, cracking etc. These bearing failures can be minimized by selecting the proper mounting method and lubricant, as well as the bearing most suitable for the application.

3.2 Calculation of service life

Basic dynamic load rating, C

The basic dynamic load rating is either pure radial (for radial bearings) or central axial load (for thrust bearings) of constant magnitude in a constant direction, under which the basic rating life of 1 million revolutions can be obtained, when the inner ring rotates while the outer ring is stationary, or vice versa. The basic dynamic load rating, which represents the capacity of a bearing under rolling fatigue, is specified as the **basic dynamic radial load rating** (C_r) for radial bearings, and **basic dynamic axial load rating** (C_a) for thrust bearings. These load ratings are listed in the specification table.

These values are prescribed by ISO 281/1990, and are subject to change by conformance to the latest ISO standards.

3.3 Basic rating life

Generally, the relationship between the dynamic load rating, dynamic equivalent load and basic rating life of needle roller bearings is expressed as follows.

$$L_{10} = \left(\frac{C}{P}\right)^{10/3} \dots\dots\dots (3.1)$$

where :

L_{10} : basic rating life	10 ⁶ revolutions
C : basic dynamic load rating	N
P : dynamic equivalent load	N

It is convenient to express the basic rating life in terms of time, using equation, when a bearing is used for operation at a constant speed.

In this case, it can be obtained by the following equation.

$$L_{10h} = \left(\frac{C}{P}\right)^{10/3} \frac{10^6}{60n} \dots\dots\dots (3.2)$$

where :

L_{10h} : basic rating life	h
n : rotational speed	min ⁻¹

Accordingly, where the dynamic equivalent load is P , and rotational speed is n , **Equation (3.3)** can be used to calculate the basic dynamic load rating C ; the bearing size most suitable for a specified purpose can then be selected, referring to the bearing specification table.

$$C = P \left(L_{10h} \times \frac{60n}{10^6}\right)^{3/10} \dots\dots\dots (3.3)$$

3.4 Corrected rating life

Generally, basic rating life of bearing (L_{10}) is regarded as a standard when its reliability is 90 %, and it can be expressed using **Equation (3.1)**. A certain application requires a service life whose reliability is more than 90 %.

The service life may be extended if special material is used, or it may be affected by operating conditions (installation, lubrication, dust-prevention, and operating temperature). In such cases, the basic rating life (L_{10}) is corrected using reliability coefficient (a_1), bearing characteristic coefficient (a_2), and operating condition coefficient (a_3). The corrected life, corrected rating life (L_{na}), can be expressed using equation below.

$$L_{na} = a_1 \cdot a_2 \cdot a_3 \cdot L_{10} \dots\dots\dots (3.4)$$

where :

L_{na} : corrected rating life	10 ⁶ revolutions
estimated reliability (100- n) % : the probability of failure occurrence is expressed by n , taking bearing characteristics and operating conditions into consideration.	

L_{10} : basic rating life	10 ⁶ revolutions
(estimated reliability 90 %)	

a_1 : reliability coefficient refer to section (1)

a_2 : bearing characteristic coefficient refer to section (2)

a_3 : operating condition coefficient refer to section (3)

3 Bearing service life and load rating

(1) Reliability coefficient (a_1)

Table 3.1 describes reliability coefficient, a_1 , which is necessary to obtain the corrected rating life of reliability greater than 90 %.

Table 3.1 Reliability coefficient values a_1

Reliability, %	L_{na}	a_1
90	L_{10a}	1.00
95	L_{5a}	0.62
96	L_{4a}	0.53
97	L_{3a}	0.44
98	L_{2a}	0.33
99	L_{1a}	0.21

(2) Bearing characteristic coefficient (a_2)

The bearing characteristic in relation to bearing life may differ according to bearing materials (steel types and their quality), and may be altered by production process, design, etc. In such cases, the bearing life calculation can be corrected using the bearing characteristic coefficient a_2 .

JTEKT has employed vacuum-degassed bearing steel as JTEKT standard bearing material. It has a significant effect on bearing life extension which was verified through studies at JTEKT research & development center.

The basic dynamic load rating of bearings made of vacuum-degassed bearing steel is specified in the bearing specification table, taking the bearing characteristic coefficient as $a_2 = 1$.

For bearings made of special materials to extend fatigue life, the bearing characteristic coefficient is treated as $a_2 > 1$.

(3) Operating condition coefficient (a_3)

When bearings are used under operating conditions which directly affect their service life, including improper lubrication, the service life calculation can be corrected by using a_3 . It is difficult to indicate a_3 generally in the case of special operating conditions that may influence the distribution of load in bearings, and it must be considered individually. When the bearing is adequately lubricated (or the rolling surfaces are separated by an oil film) a_3 is 1.

In the following cases, the operating condition coefficient is treated as $a_3 < 1$:

- Operation using lubricant of low kinematic viscosity
 - (Ball bearing.....13 mm²/s or less)
 - (Roller bearing.....20 mm²/s or less)
- Operation at very slow rotational speed
 - (Product of rolling element pitch diameter)
 - (and rotational speed is 10 000 or less.)
- Contamination of lubricant is expected

When, on the other hand, an exceptionally good lubrication is utilized, a_3 may be greater than 1. If lubricating condition is improper and the calculation is performed with $a_3 < 1$, the bearing characteristic coefficient a_2 is usually less than 1.

3.5 Correction of basic dynamic load rating

The rating life of a bearing is affected to an appreciable extent by the operating temperature and the bearing hardness. Therefore, when the bearing is used in an extreme temperature or when the bearing hardness must be lower than standard, it is necessary to correct the dynamic load rating.

(1) Bearing temperature and basic dynamic load rating

In high temperature operation, bearing material hardness deteriorates, as material compositions are altered. As a result, the basic dynamic load rating is diminished. Once altered, material composition is not recovered, even if operating temperatures return to normal.

Therefore, for bearings used in high temperature operation, the basic dynamic load rating should be corrected by multiplying the basic dynamic load rating values specified in the bearing specification table by the temperature coefficient values in Table 3.2.

Table 3.2 Temperature coefficient values

Bearing temperature, °C	125	150	175	200	250
Temperature coefficient	1	1	0.95	0.90	0.75

(2) Hardness and dynamic load rating

When the needle roller bearing is used without an inner ring, or as a cage and needle roller assembly only, it is necessary to take into account the hardness of the raceway surface, since the shaft and/or housing is used as the raceway on which rolling elements run. Therefore, when the hardness of these surfaces is lower than the standard, 60 HRC, the load rating should be corrected by using hardness coefficient given in Fig. 3.1.

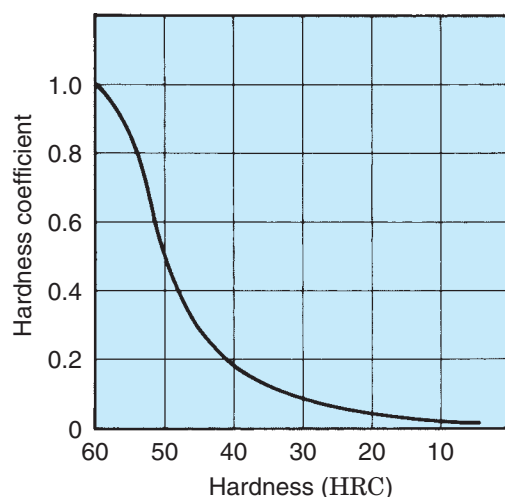

Fig. 3.1 Hardness Coefficient

4 Bearing load

4.1 Dynamic equivalent load

Bearings are used under various operating conditions; however, in most cases, bearings receive radial and axial load combined, while the load magnitude fluctuates during operation. Therefore, it is impossible to directly compare the actual load and basic dynamic load rating. The two are compared by replacing the loads applied to the shaft center with one of a constant magnitude and in a specific direction, that yields the same bearing service life as under actual load and rotational speed. This theoretical load is referred to as the dynamic equivalent load (P).

In the case of needle roller bearings, the radial bearing is subjected to radial load only, and the thrust bearing, to axial load only. The equivalent load can be obtained from the following equation.

$$\text{(Radial bearings) } P = F_r \text{ (4.1)}$$

$$\text{(Thrust bearings) } P = F_a \text{ (4.2)}$$

where :

P : dynamic equivalent load	N
F_r : radial load	N
F_a : axial load	N

4.2 Static equivalent load

The static equivalent load is a theoretical load calculated such that, during rotation at very low speed or when bearings are stationary, the same contact stress as that imposed under actual loading condition is generated at the contact center between raceway and rolling element to which the maximum stress is applied.

For radial bearings, radial load passing through the bearing center is used for the calculation; for thrust bearings, axial load in a direction along the center shaft is used.

The static equivalent load of a needle roller bearing can be calculated using the following equations :

$$\text{(Radial bearings) } P_0 = F_r \text{ (4.3)}$$

$$\text{(Thrust bearings) } P_0 = F_a \text{ (4.4)}$$

where :

P_0 : static equivalent load	N
--------------------------------	---

4.3 Load Applied to the Bearing

Generally, loads affecting bearings includes force exerted by the weight of the object the bearings support, transmission force of devices such as gears and belts, loads generated in equipment during operation etc.

Seldom can these kinds of load be determined by simple calculation, because the load is not always constant.

In many cases, the load fluctuates, and it is difficult to determine the frequency and magnitude of the fluctuation.

Therefore, loads are normally obtained by multiplying theoretical values with various coefficients obtained empirically.

(1) Coefficient for belt transmission

In the case of a belt transmission, firstly the force acting on the pulley should be obtained by the following equation.

- Torque affecting pulley (M)

$$M = 19.1 \times 10^6 W / n \text{ (mN} \cdot \text{m) (4.5)}$$

- Effective belt transmission force (K_b)

$$K_b = M / D_p \text{ (N) (4.6)}$$

where :

W : transmission force	kW
D_p : pitch circle diameter of pulley	mm
n : rotational speed	min^{-1}

In addition to the transmission force thus obtained, the belt tension must be taken into account to obtain the load which acts on the pulley shaft. This can be done by simply multiplying the driving force by a belt coefficient given in **Table 4.1** according to the type of the belt and the belting arrangement.

$$F_b = f_b \cdot K_b \text{ (4.7)}$$

where :

F_b : load affecting pulley shaft	N
f_b : belt coefficient (see Table 4.1)	

Table 4.1 Values of belt coefficient f_b

Belt type	f_b
V-belt	2.0 – 2.5
Flat belt (with tension pulley)	2.5 – 3.0
Flat belt	4.0 – 5.0

[Note] Use larger f_b values for shorter shaft distance and slower speed.

(2) Gear coefficient

In the case of gear transmission, loads transmitted by gearing are theoretically classified into three types : tangential load (K_t), radial load (K_r) and axial load (K_a).

These loads can be calculated by finding the transmission force and gear type. To spur gears, radial load is applied, while radial load and axial load are applied to bevel gears, worm gears, and helical gears. To take a spur gear as the simplest example, load acting on it can be determined by the equation below.

4 Bearing load

Also, mean rotational speed n_m can be calculated using the following equation :

$$n_m = \frac{n_1 t_1 + n_2 t_2 + \dots + n_n t_n}{t_1 + t_2 + \dots + t_n} \quad (4.15)$$

When the load varies in a stageless fluctuation as shown in **Fig. 4.2**, the following equation is useful to approximate the mean dynamic equivalent load.

$$P_m = \frac{P_{\min} + 2 P_{\max}}{3} \quad (4.16)$$

where :

P_{\min} : minimum dynamic equivalent load	N
P_{\max} : maximum dynamic equivalent load	N

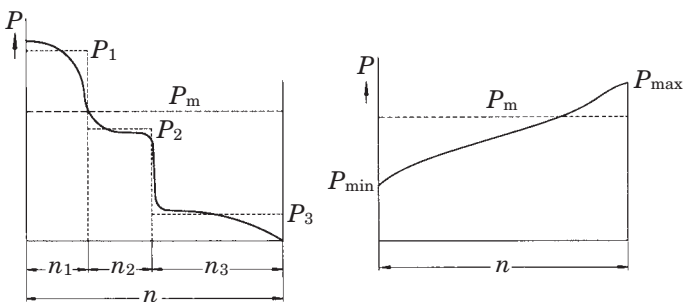

Fig. 4.1

Fig. 4.2

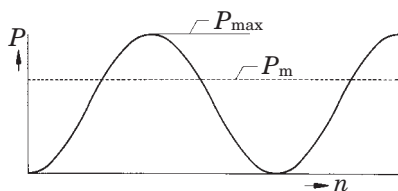

Fig. 4.3

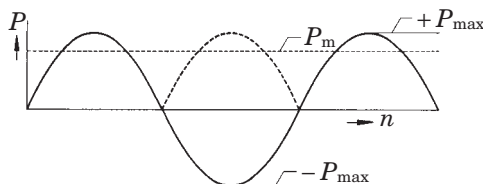

Fig. 4.4

When the load fluctuates between 0 and P_{\max} in the form of a sine curve as in **Fig. 4.3**, an approximation of mean dynamic equivalent load can be calculated by the following equation :

$$P_m \doteq 0.68 P_{\max} \quad (4.17)$$

When the load fluctuates between 0 and P_{\max} in the upper half of a sine curve as in **Fig. 4.4** an approximation of mean dynamic equivalent load can be calculated by the following equation :

$$P_m \doteq 0.75 P_{\max} \quad (4.18)$$

4.5 Limiting speed

The rotational speed of a bearing is normally affected by friction heat generated in the bearing. If the heat exceeds a certain amount, seizure or other failures occur, thus causing rotation to be discontinued.

The limiting speed is the highest speed at which a bearing can continuously operate without generating such critical heat.

The limiting speed differs depending on various factors including bearing type, dimensions and their accuracy, lubrication, lubricant type and amount, shapes of cages and materials and load conditions, etc.

The limiting speed determined under grease lubrication and oil lubrication (oil bath) for each bearing type are listed in the bearing specification table.

These speeds are applied when bearings of standard design are rotated under normal load conditions (approximately, $C/P \geq 13$).

When the load condition is $C/P < 13$, i.e. the dynamic equivalent load P exceeds approximately 8 % of basic dynamic load rating C , the limiting speed should be corrected by using **Equation (4-19)** :

$$n_a = f_1 \cdot n \quad (4.19)$$

where :

- n_a : corrected limiting speed min^{-1}
- f_1 : correction coefficient determined from the load magnitude (**Fig 4.5**)
- n : limiting speed under normal load condition (values in the Specification tables of needle roller bearings)

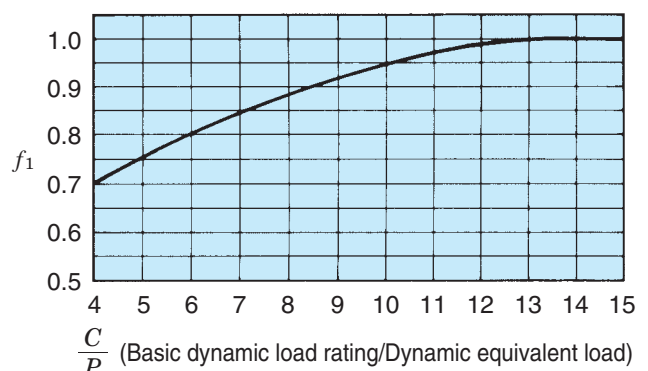

Fig. 4.5

5 Shaft and housing

5.1 Accuracy and roughness

The needle roller bearing is designed to be thin, particularly in the inner and outer rings. In the case of the bearing without inner or outer rings, the shaft or housing are used

as raceway surfaces, therefore material heat treatment and machining accuracy are important coefficients in the design of the shaft and housing.

The accuracy and roughness required for them to act as raceway and fitting surfaces are shown in **Table 5.1**.

Table 5.1 Accuracy and roughness of shafts and housings (Drawn cup needle roller bearings, Needle roller and cage assemblies, Machined ring needle roller bearings)

Item	Shaft		Housing bore	
	Raceway surface	Fitting surface	Raceway surface	Fitting surface
Roundness	Best if less than one half or one third of the shaft diameter tolerance		Best if less than one half or one third of the bore diameter tolerance	
Cylindricity	5 μm or less per 25 mm, or one half or less of the shaft diameter tolerance		5 μm or less per 25 mm, or one half or less of the bore diameter tolerance	
Roughness (Ra)	0.4 α or less	0.8 α or less	0.6 α or less	1.6 α or less
Hardness	58 HRC or harder ¹⁾ (60 to 64 HRC are best.)	—	58 HRC or harder ¹⁾ (60 to 64 HRC are best.)	—
Shaft Slope	Max. 13 μm per 25 mm length			

[Note] 1) Case hardened steel which is carburized or induction-hardened should not only meet the surface hardness requirement specified above but also have a case depth of 52.3 HRC (550 HV) to a depth in the range (0.08 to 0.1) $\times D_w$ mm. (D_w : roller diameter)
In general, 30 thru 45 HRC is best for the center hardness.

5.2 Material

The material for the shaft and housing to be used as the raceway surface must have sufficient rigidity and hardness, excellent wear and impact load resistance, dimensional stability, and long rolling fatigue life.

The materials generally used for the shaft or housing to be used as the raceway surface are as shown in **Table 5.2**. It is also required that the hardened case after heat treatment be of a fine and uniform martensite structure.

5.3 Mounting Dimensions

In the case of machined ring needle roller bearings, the fillet radius (R) of the housing must be smaller than the minimum value of the bearing chamfer (r) (the same holds true for the shaft filled seating a bearing with inner ring). For details of the mounting dimensions, refer to the opening paragraph for each type.

Table 5.2 Materials for shaft or housing used as raceway surface

Type of Steel	Symbol	JIS
High carbon chromium bearing steel	SUJ2	G4805
Chromium molybdenum steel (carburized)	SCM415, SCM420	G4053
Nickel chromium molybdenum steel (carburized)	SNCM415, SNCM420	
Chromium steel (carburized)	SCr415, SCr420	
Nickel chromium steel (carburized)	SNC415, SNC815	
Carbon steel	S50C, S55C	G4051

6 Fits

The purpose of fit is to securely fix the inner or outer ring to the shaft or housing, to preclude detrimental circumferential sliding on the fitting surface.

Such detrimental sliding (referred to as "creep") will cause abnormal heat generation, wear of the fitting surface, infiltration of abrasion metal particles into the bearing, vibration, and many other harmful effects, which cause a deterioration of bearing functions.

6.1 Fit selection

In selecting the proper fit, careful consideration should be given to bearing operating conditions.

Major specific considerations are :

- Direction of load
- Load characteristics and magnitude
- Temperature distribution in operating
- Bearing internal clearance
- Surface finish, material and thickness of shaft and housing
- Mounting and dismounting methods
- Necessity to compensate for shaft thermal expansion at the fitting surface
- Bearing type and size

In view of these considerations, the following paragraphs explain the details of the important factors in fit selection.

(1) Direction of load

Direction of load classified into three types : rotating inner ring load; rotating outer ring load and indeterminate direction load.

Table 6.1 tabulates the relationship between these characteristics and fit.

Table 6.1 Direction of Load and Fits

Direction of load		Rotating Ring		Type of load	Fit	
		Inner ring	outer ring		Inner ring	outer ring
Rotating inner ring load	Inner ring : Circumferential load	Rotating	Stationary	Rotating load	Tight	Loose
	Outer ring : Point load					
Rotating outer ring load	Inner ring : Point load	Stationary	Rotating	Rotating load	Loose	Tight
	Outer ring : Circumferential load					
Indeterminate direction load	Inner ring : Circumferential load	Rotating	Stationary	Stationary load > Rotating load	Tight	Slightly tight
	Outer ring : Oscillating load					
	Inner ring : Oscillating load	Rotating	Stationary	Stationary load > Rotating load	Slightly tight	Tight
	Outer ring : Circumferential load					

(2) Effect of load characteristic and magnitude

When a radial load is applied, the inner ring will expand slightly. Since this expansion enlarges the circumference of the bore minutely, the initial interference is reduced.

The reduction can be calculated by the following equations :

[in the case of $F_r \leq 0.25 C_0$]

$$\Delta_{dF} = 0.08 \sqrt{\frac{d}{B}} \cdot F_r \times 10^{-3} \dots\dots\dots (6.1)$$

[in the case of $F_r \leq 0.25 C_0$]

$$\Delta_{dF} = 0.02 \frac{F_r}{B} \times 10^{-3} \dots\dots\dots (6.2)$$

where :

- Δ_{dF} : reduction of inner ring interference mm
- d : nominal bore diameter of bearing mm
- B : nominal inner ring width mm
- F_r : radial load N
- C_0 : basic static load rating N

For inner ring rotating bearings, the fit should be tight enough to prevent the inner ring from coming loose under load. Consequently, when the radial load, exceeds the C_0 value by more than 25 %, greater interference is needed. Much greater interference is needed, when impact loads are expected. In either case, the effective interference should be less than 0.001 times the shaft diameter.

(3) Effect of fitting surface roughness

The effective interference obtained after fitting differs from calculated interference due to plastic deformation of the ring fitting surface. When the inner ring is fitted, the effective interference, subject to the effect of the fitting surface finish, can be approximated by the following equations :

In the case of a ground shaft

$$\Delta_{deff} \doteq \frac{d}{d+2} \Delta_d \dots\dots\dots (6.3)$$

In the case of a turned shaft

$$\Delta_{deff} \doteq \frac{d}{d+3} \Delta_d \dots\dots\dots (6.4)$$

where :

- Δ_{deff} : effective interference mm
- Δ_d : calculated interference mm
- d : nominal bore diameter of bearing mm

7 Clearance

Bearing internal clearance is defined as the clearance between the bearing ring and the rolling elements. The total distance either inner or outer ring can be moved when the specified measuring load is applied to the ring in radial direction and the other ring is fixed is defined as radial internal clearance.

The term "residual clearance" is also defined as the original clearance decreased owing to expansion or contraction of a raceway due to fitting, when the bearing is mounted in the shaft and housing.

The term "effective clearance" is defined as the residual clearance decreased owing to dimensional change arising from temperature differentials within the bearing.

The term "operating clearance" is defined as the internal clearance present while a bearing mounted in a machine is rotating under a certain load, or, the effective clearance in-

creased due to elastic deformation arising from bearing loads.

The operating clearance is closely related to bearing performance and life. It is therefore desirable to select a clearance with a lower limit value on the positive side of zero.

When selecting the clearance, fitting conditions, temperature conditions, and tolerance of mounting dimensions must all be taken into account.

The operating clearance can be obtained from the equation in **Table 7.1**.

These calculations can be used for machined ring needle roller bearings but not for drawn cup needle roller bearings.

For the drawn cup needle roller bearings refer to page 71.

The radial internal clearances of machined ring needle roller bearings before mounting are shown in **Table 8** in page 121.

Table 7.1 Operating clearance

Operating clearance (S)	$S = S_o - (S_f + S_{t1} + S_{t2}) + S_w^*$	
Decrease of clearance due to fitting (S _f)	(In the case of hollow shaft)	(In the case of D_h ≠ ∞)
	$S_{fi} = \Delta_{deff} \frac{d}{D_i} \cdot \frac{\left(1 - \frac{d_0^2}{d^2}\right)}{\left(1 - \frac{d_0^2}{D_i^2}\right)}$	$S_{fo} = \Delta_{Deff} \frac{D_e}{D} \cdot \frac{\left(1 - \frac{D^2}{D_h^2}\right)}{\left(1 - \frac{D_e^2}{D_h^2}\right)}$
Decrease of clearance due to temperature differentials between inner and outer rings (S _{t1})	(In the case of solid shaft)	(In the case of D_h = ∞)
	$S_{fi} = \Delta_{deff} \frac{d}{D_i}$	$S_{fo} = \Delta_{Deff} \frac{D_e}{D}$
Decrease of clearance due to temperature rise of rolling element (S _{t2})	<p>The amount of decrease varies depending on the state of housing; however, generally the amount can be approximated by the following equation on the assumption that the outer ring will not expand :</p> $S_{t1} = \alpha (D_i \cdot t_i - D_e \cdot t_e)$	<p>where : $D_e = D_i + 2D_w$ Consequently, S_{t1} + S_{t2} will be determined by the following equation :</p> $S_{t1} + S_{t2} = \alpha \cdot D_i \cdot t_1 + 2\alpha \cdot D_w \cdot t_2$ <p>Temperature differential between the inner and outer rings, t₁, can be expressed as follows : t₁ = t_i - t_e Temperature differential between the rolling element and outer ring, t₂, can be expressed as follows : t₂ = t_w - t_e</p>
Decrease of clearance due to temperature rise of rolling element (S _{t2})	$S_{t2} = 2\alpha \cdot D_w \cdot t_w$	

In **Table 7.1**,

S : operating clearance	mm	Δ _{Deff} : effective interference of outer ring	mm
S _o : clearance before mounting	mm	D _h : outside diameter of housing	mm
S _f : decrease of clearance due to fitting	mm	D _e : outer ring raceway contact diameter roller bearing ... $D_e \cong 0.25(3D + d)$	mm
S _{fi} : expansion of inner ring raceway contact diameter	mm	D : nominal outside diameter	mm
S _{fo} : contraction of outer ring raceway contact diameter	mm	α : linear expansion coefficient of bearing steel (12.5×10 ⁻⁶)	1/°C
S _{t1} : decrease of clearance due to temperature differentials between inner and outer rings	mm	D _w : average diameter of rolling elements roller bearing ... $D_w \cong 0.25(D - d)$	mm
S _{t2} : decrease of clearance due to temperature rise of the rolling elements	mm	t _i : temperature rise of the inner ring	°C
S _w : increase of clearance due to load	mm	t _e : temperature rise of the outer ring	°C
Δ _{deff} : effective interference of inner ring	mm	t _w : temperature rise of rolling elements	°C
d : nominal bore diameter (shaft diameter)	mm		
d ₀ : bore diameter of hollow shaft	mm		
D _i : inner ring raceway contact diameter roller bearing ... $D_i \cong 0.25(D + 3d)$	mm		

■ Bearings are sometimes used with a non-steel shaft or housing.

In the automotive industry, a statistical method is often incorporated for selection of clearance.

In these cases, or when other special operating conditions are involved, JTEKT should be consulted.

8 Lubrication and sealing devices

8.1 Purpose of lubrication

Lubrication is one of the most important factors determining bearing performance. Since the suitability of the lubricant and lubrication method have a dominant influence on bearing life, the most suitable lubricant should be selected according to operating conditions.

Functions of lubrication :

- To lubricate each part of the bearing, and to reduce friction and wear
- To carry away heat generated inside bearing due to friction and other causes
- To cover rolling contact surface with the proper oil film in order to prolong bearing fatigue life
- To prevent corrosion and contamination by dirt

Although the same general rules for ball bearings and roller bearings can also be applied to needle roller bearing lubrication, the following points should also be considered :

- The space in the bearing is very small; thus, only a little lubricant can be retained.
- The bearing is relatively wide, so circulating the lubricant through the bearing is difficult.
- In the case of full complement type sliding contact between rollers may arise.
- Rollers may skew during rotation.
- Often used in the application where oscillating motion is present.

Accordingly, these points must be given sufficient consideration when selecting the lubricant and method of lubrication.

8.2 Lubricant

Bearing lubrication is classified broadly into two categories : grease lubrication and oil lubrication. **Table 8.1** makes a general comparison between the two.

Table 8.1 Comparison between grease and oil lubrication

Item	Grease	Oil
Sealing device	Easy	Slightly complicated and special care required for maintenance
Lubricating ability	Good	Excellent
Rotation speed	Low/medium speed	Applicable at high speed as well
Replacement of lubricant	Slightly troublesome	Easy
Life of lubricant	Relatively short	Long
Cooling effect	No cooling effect	Good (circulation is necessary)
Filtration of dirt	Difficult	Easy

8.3 Grease lubrication

Generally, the bearing grease should be highly stable without containing impurities, free acid or free alkali.

Grease is made by mixing and dispersing a solid of high oil-affinity (called a thickener) with lubricant oil (as a base), and transforming it into a semi-solid state.

As well, a variety of additives can be added to improve specific performance.

Many types of grease are marketed in various combinations of thickener, base oil and additives according to the purposes. So, it is very important to select proper types of grease.

The characteristics of various greases are shown in **Table 8.2**.

Table 8.2 Characteristics of respective greases

	Lithium grease			Calcium grease (cup grease)	Sodium grease (fiber grease)	Complex base grease		Non-soap base grease		
	Mineral oil	Synthetic oil (diester oil)	Synthetic oil (silicon oil)	Calcium soap	Sodium soap	Lithium complex soap	Calcium complex soap	Bentone	Urea compounds	Fluorine compounds
Thickener	Lithium soap			Calcium soap	Sodium soap	Lithium complex soap	Calcium complex soap	Bentone	Urea compounds	Fluorine compounds
Base oil	Mineral oil	Synthetic oil (diester oil)	Synthetic oil (silicon oil)	Mineral oil	Mineral oil	Mineral oil	Mineral oil	Mineral oil	Mineral/synthetic oil	Synthetic oil
Dropping point (°C)	170 to 190	170 to 230	220 to 260	80 to 100	160 to 180	250 or higher	200 to 280	—	240 or higher	250 or higher
Operating temperature range (°C)	-30 to +120	-50 to +130	-50 to +180	-10 to +70	0 to +110	-30 to +150	-10 to +130	-10 to +150	-30 to +150	-40 to +250
Rotation speed range	Medium to high	High	Low to medium	Low to medium	Low to high	Low to high	Low to medium	Medium to high	Low to high	Low to medium
Mechanical stability	Excellent	Good to excellent	Good	Fair to good	Good to excellent	Good to excellent	Good	Good	Good to excellent	Good
Water resistance	Good	Good	Good	Good	Bad	Good to excellent	Good	Good	Good to excellent	Good
Pressure resistance	Good	Fair	Bad to fair	Fair	Good to excellent	Good	Good	Good to excellent	Good to excellent	Good
Remarks	Most widely usable for various rolling bearings.	Superior low temperature and friction characteristics. Suitable for bearings for measuring instruments and extra-small ball bearings for small electric motors.	Superior high and low temperature characteristics.	Suitable for applications at low rotation speed and under light load. Not applicable at high temperature.	Liable to emulsify in the presence of water. Used at relatively high temperature.	Superior mechanical stability and heat resistance. Used at relatively high temperature.	Superior pressure resistance when extreme pressure agent is added. Used in bearings for rolling mills.	Suitable for applications at high temperature and under relatively heavy load.	Superior water resistance, oxidation stability, and heat stability. Suitable for applications at high temperature and high speed.	Superior chemical resistance and solvent resistance. Usable at up to 250 °C.

(1) Base oil

Mineral oil is usually used as the base oil for grease. When low temperature fluidity, high temperature stability, or other special performance is required, diester oil, silicon oil, polyglycolic oil, fluorinated oil, or other synthetic oil is often used.

Generally, grease with a low viscosity base oil is suitable for applications at low temperature or high rotation speed; grease with high viscosity base oils are suitable for applications at high temperature or under heavy load.

(2) Thickener

Most greases use a metallic soap base such as lithium, sodium, or calcium as thickeners. For some applications, however, non-soap base thickeners (inorganic substances such as bentone, silica gel, and organic substances such as urea compounds, fluorine compounds) are also used.

In general, the mechanical stability, bearing operating temperature range, water resistance, and other characteristics of grease are determined by the thickener.

(Lithium soap base grease)

Superior in heat resistance, water resistance and mechanical stability.

(Calcium soap base grease)

Superior in water resistance; inferior in heat resistance.

(Sodium soap base grease)

Superior in heat resistance; inferior in water resistance.

(Non-soap base grease)

Superior in heat resistance.

(3) Additives

Various additives are selectively used to serve the respective purposes of grease applications.

- Extreme pressure agents
When bearings must tolerate heavy or impact loads.
- Oxidation inhibitors
When grease is not refilled for a long period.
Structure stabilizers, rust preventives, and corrosion inhibitors are also used.

(4) Consistency

Consistency, which indicates grease hardness, is expressed as a figure obtained, in accordance with ASTM (JIS), by multiplication by 10 the depth (in mm) to which the cone-shaped metallic plunger penetrates into the grease at 25 °C by deadweight in 5 seconds. The softer the grease, the higher the figure.

Table 8.3 shows the relationships between the NLGI scales and ASTM (JIS) penetration indexes, service conditions of grease.

(NLGI : National Lubricating Grease Institute)

It is imperative that the bearing operating temperature is always within the temperature range specified for the grease used. Although softer greases provide better lubrication, they are more likely to be churned. Since grease churning tends to cause temperature rise and leakage, this characteristic should be taken into account when selecting grease consistency. For ordinary operating conditions, greases of NLGI No. 0 to 3 are commonly used. When the bearing operating speed is higher, a somewhat harder grease with high mechanical stability should be selected.

Table 8.3 Grease consistency and service conditions

ASTM (JIS) penetration index (25 °C, 60 mixing operations)	NLGI scale	Service conditions/ applications
355 – 385	0	For centralized lubricating
310 – 340	1	For centralized lubricating, at low temperature
265 – 295	2	For general use
220 – 250	3	For general use, at high temperature
175 – 205	4	For special applications

[Note] The larger the penetration index, the softer is the grease.

(5) Mixing of different greases

Since mixing of different greases changes their properties, greases of different brands should not be mixed.

If mixing cannot be avoided, greases containing the same thickener should be used. Even if the mixed greases contain the same thickener, however, mixing may still produce adverse effects, due to difference in additives or other factors.

Thus it is necessary to check the effects of a mixture in advance, through testing or other methods.

8.4 Replenishment/replacement of grease

The method of replenishing/replacing grease depends largely on the lubrication method. Whichever method may be utilized, care should be taken to use clean grease and to keep dirt or other foreign matter out of the housing.

In addition, it is desirable to refill with grease of the same brand as that filled at the start.

When grease is refilled, new grease must be injected

inside bearing.

In case of high speed operation or a small air space, because it is necessary to replenish grease often, a grease inlet should be provided as near the bearing as possible so that the deteriorated grease may be replaced by new grease.

Under normal operating conditions, grease life may be approximated by the graphs shown in **Fig. 8.1**. It is recommended you use this diagram as a guide for replenishment and replacement of grease.

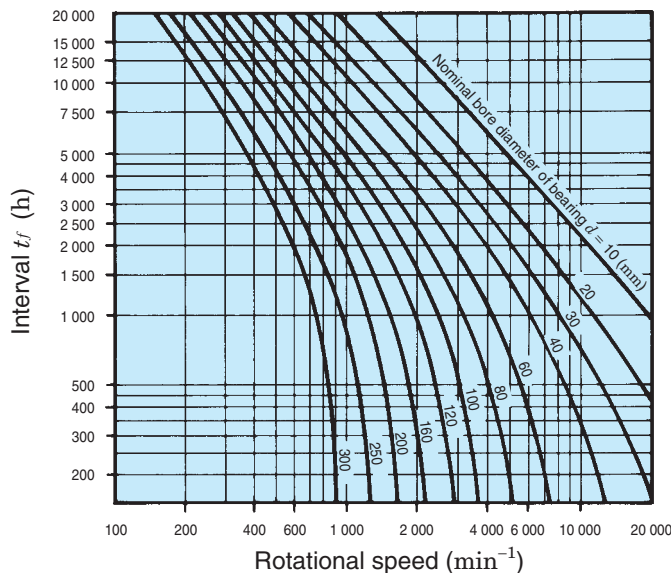

Fig. 8.1 Grease feeding interval

■ Temperature correction

When the bearing operating temperature exceeds 70 °C, t_f' , obtained by multiplying t_f by correction coefficient a , found on the scale below, should be applied as the feeding interval.

$$t_f' = t_f \cdot a$$

Temperature correction coefficient a

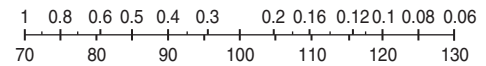

Bearing operating temperature T °C

8.5 Oil lubrication

For bearing lubrication, oils with high mechanical and chemical stability are preferred. Therefore, high quality mineral oils are generally used. They are least likely to form heterogeneous mixtures or gummy compounds, or to be oxidized.

It is also important that the oil should be free from dirt or foreign material. In selecting lubricating oil, it is essential to select an oil with proper viscosity. Generally the oil should have a viscosity of 12 to 15 mm^2/s at the operating tem-

perature of the bearing.

When the bearing is to be used in a wide range of temperatures, the oil should have a high viscosity index. For heavy or impact load, use oils with high film strength. For high speed applications, lower viscosity oils are desirable.

To aid you in the selection of lubricating oil, the relationship between viscosity and operating temperature is shown in **Fig. 8.2**.

Examples of lubricating oil selection for various operating conditions are shown in **Table 8.4**.

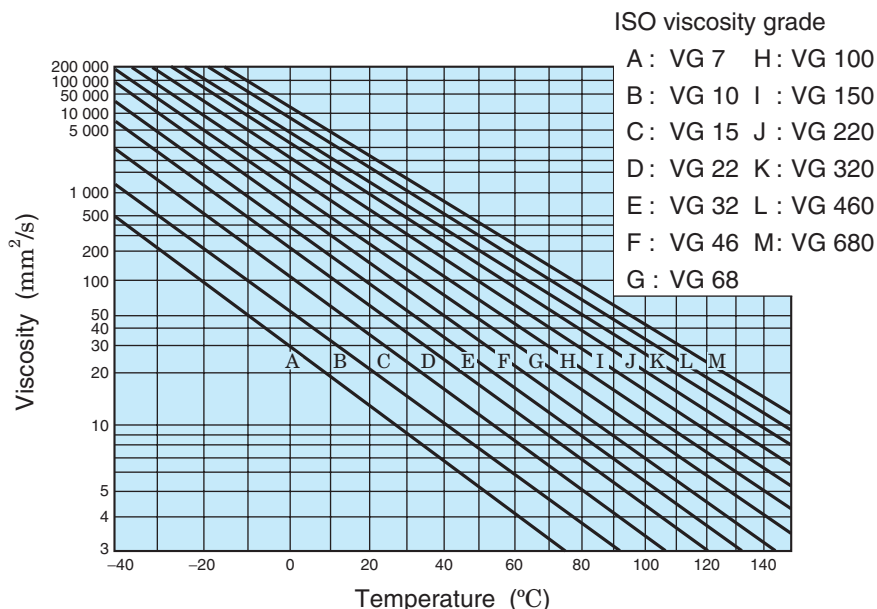

Fig. 8.2 Relationship between lubricating oil viscosity and temperature (viscosity index : 100)

Table 8.4 Proper kinematic viscosities by bearing operating conditions

Operating temperature	d_{mn} value	Proper kinematic viscosity (expressed in the ISO viscosity grade or the SAE No.)		
		Light/normal load		Heavy/impact load
-30 to 0 °C	All rotation speeds	ISO VG 15, 22, 46	(Refrigerating machine oil)	—
0 to 60 °C	300 000 or lower	ISO VG 46	(Bearing oil Turbine oil)	ISO VG 68 SAE 30 (Bearing oil Turbine oil)
	300 000 to 600 000	ISO VG 32	(Bearing oil Turbine oil)	ISO VG 68 (Bearing oil Turbine oil)
	600 000 or higher	ISO VG 7, 10, 22	(Bearing oil)	—
60 to 100 °C	300 000 or lower	ISO VG 68	(Bearing oil)	ISO VG 68, 100 SAE 30 (Bearing oil)
	300 000 to 600 000	ISO VG 32, 46	(Bearing oil Turbine oil)	ISO VG 68 (Bearing oil Turbine oil)
	600 000 or higher	ISO VG 22, 32, 46	(Bearing oil Turbine oil Machine oil)	—
100 to 150 °C	300 000 or lower	ISO VG 68, 100 SAE 30, 40	(Bearing oil)	ISO VG 100 to 460 (Bearing oil Gear oil)
	300 000 to 600 000	ISO VG 68 SAE 30	(Bearing oil Turbine oil)	ISO VG 68, 100 SAE 30, 40 (Bearing oil)

- [Remarks] 1. $d_{mn} = \frac{D+d}{2} \times n \dots$ { D : nominal outside diameter (mm), d : nominal bore diameter (mm),
 n : rotational speed (min^{-1}) }
2. Refer to refrigerating machine oil (JIS K 2211), turbine oil (JIS K 2213), gear oil (JIS K 2219), machine oil (JIS K 2238) and bearing oil (JIS K 2239).
3. Please contact with JTEKT if the bearing operating temperature is under -30 °C or over 150 °C.

8.6 Oil lubrication method

Oil lubrication is usable even at high speed rotation and somewhat high temperature, and is effective in reducing bearing vibration and noise.
Thus oil lubrication is used in many cases where grease

lubrication does not work.
The lubrication methods often used for needle roller bearings are shown in **Table 8.5**. Also available are oil jet lubrication and oil mist lubrication methods. However, because of a limitation on rotating speed for needle roller bearings, these are not usually employed.

Table 8.5 Oil lubrication methods

Method	Description	Remarks
Oil bath	This is the most popular method. The oil level is adjusted to the center of the lowest roller of the bearing. The oil level may vary depending on the operating speeds. A somewhat lower level is recommended for higher speeds. In the case of low speeds, there may not be a problem of over lubrication.	Used for low to medium rotating speeds.
Oil splash	Gears or simple flinger are attached to the shaft to feed the oil by splashing. When used on a gear device, it is advisable to use a shielded bearing or baffle to prevent the intrusion of metal particles from the gear, or contaminants, into the bearing.	Used for the gear box of machine tools and automotive transmissions, etc.
Oil drip	Oil is dripped by means of a visible oiler. The rate of oil supply is adjusted by a nob on top of the oiler. The oil which passed through the bearing should be drained before forming an excessive oil sump in the housing.	Used for relatively high speeds.
Forced oil circulation	The lubricating oil is circulated. An oil inlet is provided on one side of the housing, and an oil outlet on the other. The outlet should have a larger diameter than the inlet so as to prevent accumulation of excessive oil in the housing. In addition, the inlet is located in the lower half of housing so that the oil will not leak through the shaft. When the operating temperature is high, in addition to increasing the rate of oil flow, it is recommended to provide a cooling device somewhere : in the system for more efficient heat removal and extending lubricant life.	Widely used for bearings operated at high temperatures.

8.7 Sealing devices

Sealing devices not only prevent foreign matter (dirt, water, metal powder) from entering, but prevent lubricant inside from leaking. If the sealing device fails to function satisfactorily, foreign matter or leakage will cause bearing damage as a result of malfunction or seizure.

Therefore, it is necessary to design or choose the most suitable sealing devices as well as to choose the proper lubricating measures according to operating conditions.

Sealing devices may be divided into non-contact and contact types according to their structure.

They should satisfy the following conditions :

- Free from excessive friction (heat generation)
- Easy maintenance
(especially ease of mounting and dismounting)
- As low cost as possible

(1) Non-contact type sealing devices

A non-contact type sealing device, which includes oil groove, flinger (slinger), and labyrinth, eliminates friction because it does not have a contact point with the shaft.

These devices utilize narrow clearance and centrifugal force and are especially suitable for operation at high rotation speed and high temperature.

Table 8.6 (1) Non-contact type sealing devices

(1) Oil groove

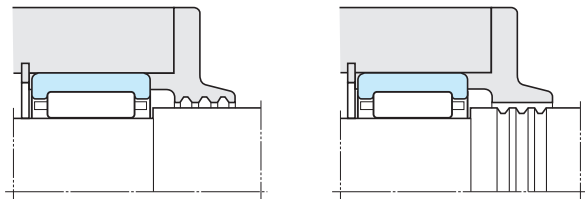

(a)

(b)

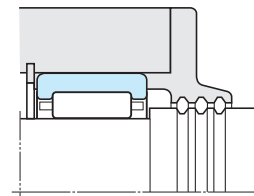

(c)

- This kind of seal having more than three grooves at the narrow clearance between the shaft and housing cover, is usually accompanied by other sealing devices except when it is used with grease lubrication at low rotation speed.
- Preventing entrance of contaminants can be improved by filling the groove with calcium grease (cup grease) having a consistency of 150 to 200.
- The clearance between the shaft and housing cover should be as narrow as possible.
Recommended clearances are as follows.
 - Shaft diameter of less than 50 mm
..... 0.25 – 0.4 mm
 - Shaft diameter of over 50 mm
..... 0.5 – 1 mm
- Recommended dimensions for the oil groove are as follows.
 - Width 2 – 5 mm
 - Depth 4 – 5 mm

Table 8.6 (2) Non-contact type sealing devices

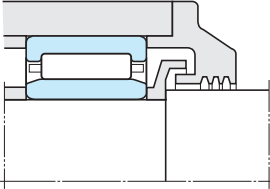
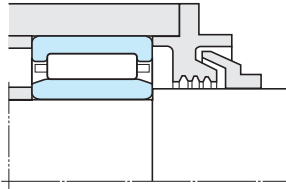
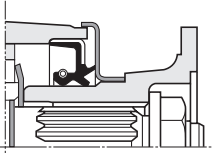
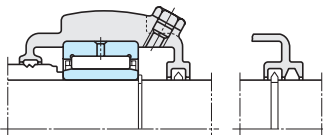
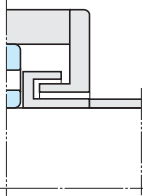
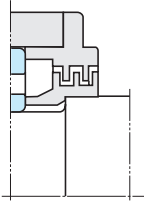
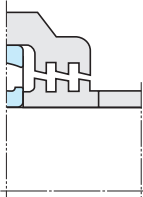
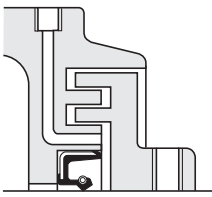
(2) Flinger (slinger)	(3) Labyrinth									
<div style="display: flex; justify-content: space-around;"> <div style="text-align: center;">  <p>(d) Flinger attached inside</p> </div> <div style="text-align: center;">  <p>(e) Flinger attached outside</p> </div> </div> <div style="display: flex; justify-content: space-around; margin-top: 20px;"> <div style="text-align: center;">  <p>(f) Cover type flinger</p> </div> <div style="text-align: center;">  <p>(g) Oil thrower</p> </div> </div>	<div style="display: flex; justify-content: space-around;"> <div style="text-align: center;">  <p>(h) Axial labyrinth</p> </div> <div style="text-align: center;">  <p>(i) Radial labyrinth</p> </div> </div> <div style="display: flex; justify-content: space-around; margin-top: 20px;"> <div style="text-align: center;">  <p>(j) Aligning labyrinth</p> </div> <div style="text-align: center;">  <p>(k) Axial labyrinth with greasing feature</p> </div> </div>									
<ul style="list-style-type: none"> ■ A flinger utilizes centrifugal force to splash away the oil and dirt. It produces an air stream which prevents oil leakage and dirt by a pumping action. In many cases, this device is used together with other sealing devices. ■ A flinger installed inside the housing (Fig. d) provides an inward pumping action, preventing lubricant leakage; and, when installed outside (Fig. e), the outward pumping action prevents infiltration of contaminants. ■ A cover type flinger (Fig. f) splashes away dirt and dust by centrifugal force. ■ The oil thrower, shown in (Fig. g), is a kind of flinger. An annular ridge on the shaft or a ring fitted onto the shaft utilizes centrifugal force to prevent the lubricant from flowing out. 	<ul style="list-style-type: none"> ■ A labyrinth provides clearance in the shape of engagements between the shaft and housing. It is the most suitable for prevention of lubricant leakage at high rotation speed. ■ Though an axial labyrinth, shown in (Fig. h), is popular because of its ease of mounting, the sealing effect is better in a radial labyrinth, shown in (Fig. i). ■ An aligning labyrinth (Fig. j) is used with self-aligning type bearings. ■ In the cases of (Fig. i) and (Fig. j), the housing or the housing cover should be split. ■ Recommended labyrinth clearances are given in the following table. <table border="1" style="width: 100%; border-collapse: collapse; text-align: center;"> <thead> <tr style="background-color: #e0f0ff;"> <th style="padding: 5px;">Shaft diameter</th> <th style="padding: 5px;">Radial clearance</th> <th style="padding: 5px;">Axial clearance</th> </tr> </thead> <tbody> <tr> <td style="padding: 5px;">50 mm or less</td> <td style="padding: 5px;">0.25 – 0.4 mm</td> <td style="padding: 5px;">1 – 2 mm</td> </tr> <tr> <td style="padding: 5px;">Over 50 mm</td> <td style="padding: 5px;">0.5 – 1 mm</td> <td style="padding: 5px;">3 – 5 mm</td> </tr> </tbody> </table> <ul style="list-style-type: none"> ■ To improve sealing effect, fill the labyrinth clearance with grease, shown in (Fig. k). 	Shaft diameter	Radial clearance	Axial clearance	50 mm or less	0.25 – 0.4 mm	1 – 2 mm	Over 50 mm	0.5 – 1 mm	3 – 5 mm
Shaft diameter	Radial clearance	Axial clearance								
50 mm or less	0.25 – 0.4 mm	1 – 2 mm								
Over 50 mm	0.5 – 1 mm	3 – 5 mm								

(2) Contact type sealing devices

This type provides a sealing effect by means of the contact of its end with the shaft and are manufactured from synthetic rubber, synthetic resin, or felt.

The synthetic rubber oil seal is most popular.

1) Oil seals

Many types and sizes of oil seals, as a finished part, have been standardized.

JTEKT produces various oil seals.

The names and functions of each oil seal part are shown in **Fig. 8.3** and **Table 8.7**. **Table 8.8** provides a representative example.

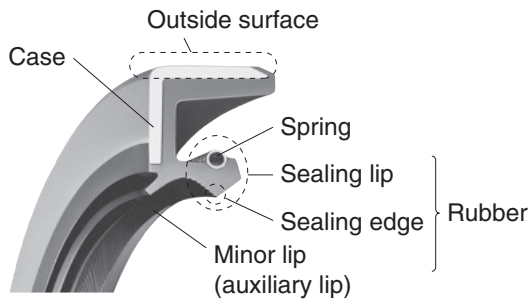

Fig. 8.3 Names of oil seal parts

Table 8.7 Complete list of oil seal part functions

Names	Functions
Sealing edge	Prevents fluid leakage by making contact with rotating shaft. (The contact surface of the sealing edge with the shaft should always be filled with lubricant, so as to maintain an oil film therein.)
Sealing lip and spring	Provides proper pressure on the sealing edge to maintain stable contact. Spring provides proper pressure on the lip and maintains such pressure for a long time.
Outside surface	Fixes the oil seal to the housing and prevents fluid leakage through the fitting surface. (Comes encased in metal cased type or rubber covered type.)
Case	Strengthens seal.
Minor lip (auxiliary lip)	Prevents entry of contaminants. (In many cases, the space between the sealing lip and minor lip is filled with grease.)

Table 8.8 Typical oil seal types

With case		With inner case	Without case
Without spring	With spring		With spring
 HM (JIS GM) MH (JIS G)	 HMS (JIS SM) MHS (JIS S) CRS	 HMSH (JIS SA)	 MS
 HMA MHA	 HMSA (JIS DM) MHSA (JIS D) CRSA	 HMSAH (JIS DA)	—

- The oil seals shown in the lower row contain the minor lip (auxiliary lip).
- Special types of seals such as the mud resistance seal, pressure resistance seal and outer seal for rotating housings can be provided to serve under various operating conditions.

- By providing a slit on the oil seals, it is possible to attach them from other points than the shaft ends.

8 Lubrication and sealing devices

Oil seals without minor lips are mounted in different directions according to their operating conditions (shown in Fig. 8.4).

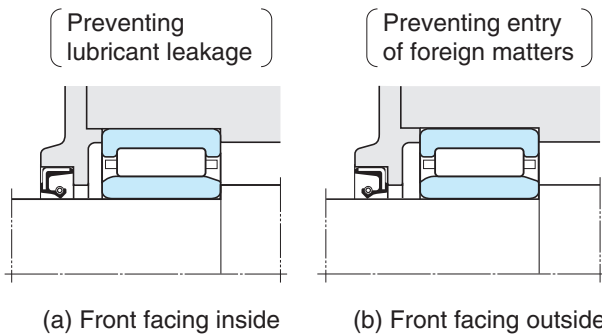

Fig. 8.4 Direction of sealing lips and their purpose

When the seal is used in a dirty operating environment, or penetration of water is expected, it is advisable to have two oil seals combined or to have the space between the two sealing lips be filled with grease. (shown in Fig. 8.5)

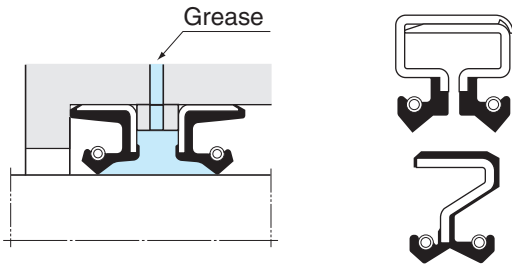

Fig. 8.5 Seals used in a dirty operating environment

Respective seal materials possess different properties. Accordingly, as shown in Table 8.9, allowable lip speed and operating temperature differ depending on the materials. Therefore, by selecting proper materials, oil seals can be used for sealing not only lubricants but also chemicals including alcohol, acids, alkali, etc.

Table 8.9 Allowable lip speed and operating temperature range of oil seals

Seal material	Allowable lip speed (m/s)	Operating temperature range (°C)
NBR	15	-40 to +120
Acrylic rubber	25	-30 to +150
Silicone rubber	32	-50 to +170
Fluoro rubber	32	-20 to +180

To ensure the maximum sealing effect of the oil seal, the shaft materials, surface roughness and hardness should be carefully chosen.

Table 8.10 shows the recommended shaft conditions.

Table 8.10 Recommended shaft conditions

Material	Machine structure steel, low alloy steel and stainless steel
Surface hardness	For low speed : harder than 30 HRC For high speed : harder than 50 HRC
Surface roughness (Ra)	0.2 – 0.6 a A surface which is excessively rough may cause oil leakage or abrasion; whereas an excessively fine surface may cause sealing lip seizure, preventing the oil film from forming. Surface must also be free of spiral grinding marks.

2) Felt seals and others

Although felt seals have been used conventionally, it is recommended to replace them with rubber oil seals because the use of felt seals are limited to the following conditions.

- Light dust protection
- Allowable lip speed : not higher than 5 m/s

Contact type sealing devices include mechanical seals, O-rings and packings other than those described herein.

JTEKT manufactures various oil seals ranging from those illustrated in Table 8.8 to special seals for automobiles, large seals for rolling mills, mud resistance seals, pressure resistance seals, outer seals for rotating housings and O-rings.

For details, refer to JTEKT separate catalog "Oil seals & O-rings" (CAT. NO. R2001E).

9 Handling of bearings

9.1 General instructions

Since rolling bearings are more precisely made than other machine parts, careful handling is absolutely necessary.

- Keep bearings and the operating environment clean. Dirt, even if it is invisible, can affect the bearing. The utmost care should be used not to let any dirt into the bearing.
- Handle carefully. Bearings are precision ground and heat-treated to have wear-resisting hardness. Therefore, they can be cracked or brinelled if they are subjected to impacts or excessive forces due to rough handling, improper mounting or dismounting practice.
- Do not expose the bearing to high temperatures. Standard bearings can be tempered if they are heated to a temperature over 120 °C, and reduction of hardness due to such tempering may shorten the bearing life.
- Handle using the proper tools. Do not use substitute jigs.
- Bearings should be handled by experienced or well trained operators.
- Keep bearings well protected from rust.
- Set bearing operation standards and follow them.
 - Storage of bearings
 - Cleaning of bearings and their adjoining parts
 - Inspection of dimensions of adjoining parts and finish conditions
 - Mounting
 - Inspection after mounting
 - Dismounting
 - Maintenance and inspection (periodical inspection)
 - Replenishment of lubricants

9.2 Bearing mounting

When mounting a bearing, never hammer the outer ring to mount the inner ring or vice versa. Otherwise, the raceway may be brinelled, causing failure on the bearing earlier than usual.

Mounting procedures depend on the type and fitting conditions of bearings. A general mounting method is described here. (For the drawn cup needle roller bearings, see page 71.)

1) Press fit

A mounting fixture is put in contact with the bearing ring (inner or outer ring) and the bearing is installed by used of a press. This is the most widely employed method. (Fig. 9.1)

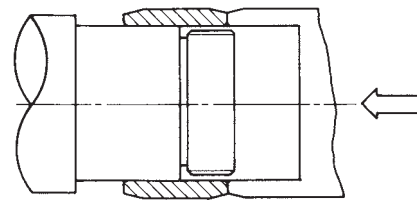

Fig. 9.1

2) Shrink fit

The inner ring is heated and expanded in oil to fit the inner ring onto the shaft.

In this case, it is important that oil temperature should not be higher than 100 °C, because bearings heated at higher than 120 °C lose hardness. The heating temperature and expansion of inner ring are shown in Fig. 9.2.

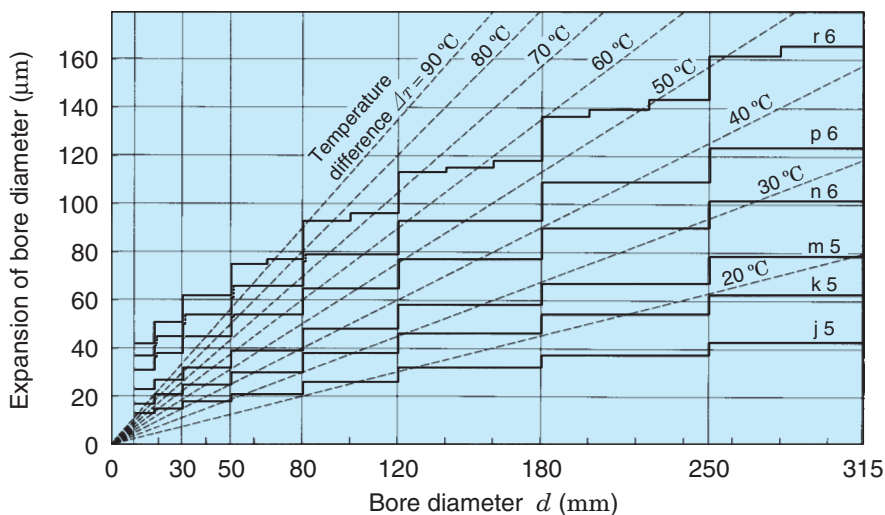

Fig. 9.2 Temperature difference and expansion of inner rings

[Note] Solid lines show the maximum interference value between bearings (class 0) and shafts (r 6, p 6, n 6, m 5, k 5, j 5) at normal temperature.

Therefore, the heating temperature should be selected to gain a larger "expansion of the bore diameter" than the maximum interference values.

9.3 Force is necessary to press fit and remove bearings

The force necessary to press fit the bearing onto the shaft or housing and remove it from them, differs depend-

ing on the finish of shafts and housings and how much interference the bearings allow.

Generally, the value can be obtained by using the equations shown in **Table 9.1**.

Table 9.1 Force necessary for press fit and removal

Shaft and inner ring	Housing bore and outer ring
<p>(Hollow shafts)</p> $K_a = 9.8 f_k \cdot \Delta_{deff} \cdot B \cdot \frac{\left(1 - \frac{d^2}{D_i^2}\right) \left(1 - \frac{d_o^2}{d^2}\right)}{\left(1 - \frac{d_o^2}{D_i^2}\right)} \cdot 10^3$	<p>$(D_h \neq \infty)$</p> $K_a = 9.8 f_k \cdot \Delta_{Deff} \cdot B \cdot \frac{\left(1 - \frac{D_e^2}{D^2}\right) \left(1 - \frac{D^2}{D_h^2}\right)}{\left(1 - \frac{D_e^2}{D_h^2}\right)} \cdot 10^3$
<p>(Solid shafts)</p> $K_a = 9.8 f_k \cdot \Delta_{deff} \cdot B \cdot \left(1 - \frac{d^2}{D_i^2}\right) \cdot 10^3$	<p>$(D_h = \infty)$</p> $K_a = 9.8 f_k \cdot \Delta_{Deff} \cdot B \cdot \left(1 - \frac{D_e^2}{D^2}\right) \cdot 10^3$

where :

K_a : force necessary for press fit or removal N

f_k : resistance coefficient (Coefficient taking into consideration friction between shafts and inner rings
 ... Press fit : $f_k = 4$, Removing : $f_k = 6$)

B : nominal inner ring width mm

Δ_{deff} : effective interference of inner ring mm

d : nominal inner ring bore diameter (shaft dia.) mm

D_i : raceway contact diameter of inner ring mm

d_o : hollow shaft bore diameter mm

Δ_{Deff} : effective interference of outer ring mm

D : nominal outside diameter (housing bore diameter) mm

D_e : raceway contact diameter of outer ring mm

D_h : outside diameter of housing mm

9.4 Test run

A trial operation is conducted to insure that the bearings are properly mounted.

In the case of compact machines, rotation may be checked by manual operation at first, followed by power operation. Large equipment may be driven from the beginning using a power source.

Idle running is performed by turning off the power source immediately after turning it on. It must be confirmed that bearings rotate smoothly without any abnormal vibration and noise, then power operation should be restarted under no load and at low speed, then the speed is gradually increased until the designed speed is reached. If any of the abnormalities are found, operation must be stopped, and inspection for defects immediately conducted.

The bearings should be dismantled, washed, checked, and remounted if necessary.

General notes are as shown below.

- The bearing unit can smoothly rotate or sealing device is not too tight.
- The slinger or labyrinth does not interfere with other parts.
- If you have rugged feels with hands, dusts or foreign matters are caught in, or the raceway surface (rolling contact surface) have flaws.
- If the running torque is uneven, improper mounting may occur.
- In power rotation test, judge with sound and temperature increase.

The use of an industrial stethoscope or a listening rods will facilitate the noise check.

Clear metallic noise indicates the bearing being poorly lubricated. Irregular noise peaks often indicate the existence of foreign matter in the bearing.

If the bearing temperature is found too high, it may be inadequately lubricated or improperly mounted.

9.5 Bearing dismounting

After dismounting bearings, handling of the bearings and the various methods available for this should be considered.

If the bearing is to be disposed of, any simple method such as torch cutting can be employed. If the bearing is to be reused or checked for the causes of its failure, the same amount of care as in mounting should be taken in dismounting so as not to damage the bearing and other parts.

Since bearings with interference fits are easily damaged during dismounting, measures to prevent damage during dismounting must be incorporated into the design.

An example of dismounting methods intended for reuse or for failure analysis is described here.

It is useful for discovering the causes of failures when the conditions of bearings, including mounting direction and location, are recorded prior to dismounting.

The bearing can be removed most easily by the use of a puller (Fig. 9.3) or a press (Fig. 9.4).

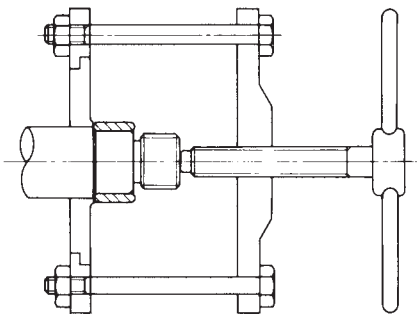

Fig. 9.3 Special tools

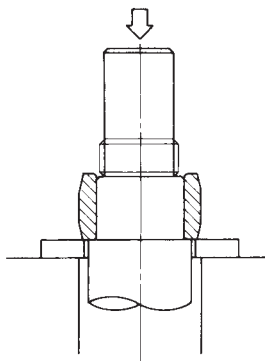
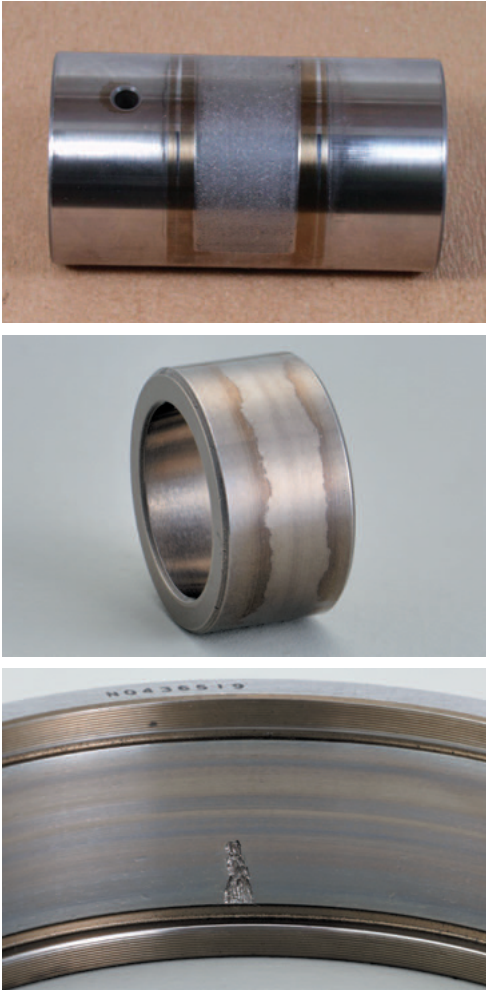
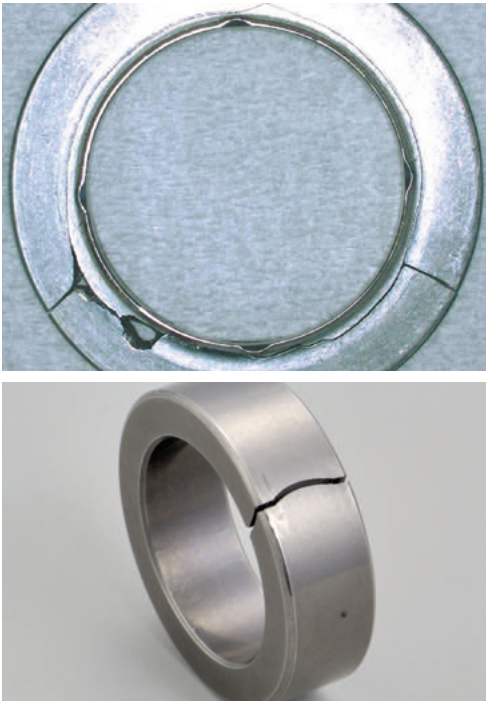

Fig. 9.4 Dismounting of inner ring by use of a press

9.6 Cleaning



To clean needle roller bearings, neutral water-free light oil or kerosene is used to clean bearings, a warm alkali solution can also be used if necessary. A dirty bearing should be cleaned using two cleaning processes, such as rough cleaning and finish cleaning. In the rough cleaning, the bearing is moved forcefully in the washing oil. Do not rotate the bearing from the beginning because foreign matter will abrade the raceway while rotating. Filtering is important so that the washing oil will remain clean at all times. Apply anti-corrosion oil or rust preventive grease on bearings immediately after cleaning.

10 Examples of bearing failures

Failures	Characteristics
<p>(1) Flaking</p>	 <p>Flaking is a phenomenon that material is removed in flakes from a surface layer of the bearing raceways or rolling elements due to rolling fatigue.</p> <p>This phenomenon is generally attributed to the approaching end of bearing service life. However, if flaking occurs at early stages of bearing service life, it is necessary to determine causes and adopt countermeasures, since there is a possibility of abnormality in such a case.</p> <p>[Reference] Pitting</p> <p>Pitting is another type of failure caused by rolling fatigue, in which minute holes of approx. 0.1 mm in depth are generated on the raceway surface.</p> <p>[Reference] Peeling (shown in middle figure)</p> <p>Peeling is a phenomenon that extra surface area (0.02 mm or less) of rolling surfaces is fatigued and peeled due to concentrated stress acting on microscopic peaks of surface roughness.</p>
<p>(2) Cracking Chipping</p>	 <p>Cracking is mainly triggered by defected areas due to wear of other materials, partial shape defects, and concentrated stress and overload caused by edge load. It may occur on bearing rings due to fatigue caused by repeated bend stress.</p>

Damages	Causes	Countermeasures
Flaking occurring at an incipient stage	<ul style="list-style-type: none"> · Too small internal clearance · Improper or insufficient lubricant · Too much load · Rust 	<ul style="list-style-type: none"> · Provide proper internal clearance. · Select proper lubricating method or lubricant.
Symmetrical flaking along circumference of raceway	<ul style="list-style-type: none"> · Inaccurate housing roundness 	<ul style="list-style-type: none"> · Correct processing accuracy of housing bore. Especially for split housings, care should be taken to ensure processing accuracy.
Flaking occurring near the edge of the raceway or rolling contact surface	<ul style="list-style-type: none"> · Improper mounting · Shaft deflection · Inaccuracy of the shaft and housing 	<ul style="list-style-type: none"> · Correct centering. · Correct squareness of shaft or housing shoulder.
Flaking on the raceway surface at the same interval as rolling element spacing	<ul style="list-style-type: none"> · Heavy impact load during mounting · A flaw caused during mounting · Rust generated while out of operation 	<ul style="list-style-type: none"> · Improve mounting procedure. · Provide rust prevention treatment before long cessation of operation.
Cracking in outer ring, inner ring or race	<ul style="list-style-type: none"> · Excessive interference · Excessive fillet on shaft or housing · Heavy impact load · Advanced flaking or seizure · Impact on race during mounting 	<ul style="list-style-type: none"> · Select proper fit. · Adjust fillet in the shaft or in the housing to smaller than that of the bearing chamfer dimension. · Re-examine load conditions. · Improve mounting procedures.
Cracking on rolling elements	<ul style="list-style-type: none"> · Heavy impact load · Advanced flaking 	<ul style="list-style-type: none"> · Improve mounting and handling procedures. · Re-examine load conditions.

10 Examples of bearing failures

Failures	Characteristics	
(3) Brinelling Nicks	<ul style="list-style-type: none"> · Brinelling is a small surface indentation generated either on the raceway through plastic deformation at the contact point between the raceway and rolling elements, or on the rolling surfaces from insertion of foreign matter, when heavy load is applied while the bearing is stationary or rotating at a low rotation speed. · Nicks are indentations produced directly by rough handling such as hammering. 	
(4) Wear	 <p>Normally, wear of bearing is observed on sliding contact surfaces such as roller end faces and rib faces, cage pockets, the guide surface of cages and cage riding lands. Wear is not directly related to material fatigue.</p> <p>Wear caused by foreign matter and corrosion can affect not only sliding surfaces but rolling surfaces.</p>	
(5) Fretting	 <p>Fretting occurs to bearings which are subject to vibration while in stationary condition or which are exposed to minute vibration. It is characterized by rust-colored wear particles.</p> <p>Since fretting on the raceways often appears similar to brinelling, it is sometimes called "falsebrinelling".</p>	
(6) Creeping	<p>Creeping is a phenomenon in which bearing rings move relative to the shaft or housing during operation.</p>	

Damages	Causes	Countermeasures
Brinelling on the raceway or rolling contact surface	· Entry of foreign matter	· Clean bearing and its peripheral parts. · Improve sealing devices.
Brinelling on the raceway surface at the same interval as the rolling element spacing	· Impact load during mounting · Excessive load applied while bearing is stationary	· Improve mounting procedure. · Improve machine handling.
Nicks on the raceway or rolling contact surface	· Careless handling	· Improve mounting and handling procedure.
Wear on the contact surfaces (cage pockets, cage riding land)	· Improper or insufficient lubricant	· Select proper lubricating method or lubricant. · Improve sealing device. · Clean the bearing and its peripheral parts.
Wear on raceways and rolling contact surfaces	· Entry of foreign matters · Improper or insufficient lubricant	
Rust-colored wear particles generated on the fitting surface (fretting corrosion)	· Insufficient interference	· Provide greater interference. · Apply lubricant to the fitting surface.
Brinelling on the raceway surface at the same interval as rolling element spacing (false brinelling)	· Vibration and oscillation when bearings are stationary.	· Improve fixing method of the shaft and housing.
Wear, discoloration, and scuffing caused by slipping on the fitting surfaces	· Insufficient interference · Insufficient tightening of sleeve	· Provide greater interference. · Proper tightening of sleeve.

10 Examples of bearing failures

Failures	Characteristics	
(7) Damage to Cages	 <p data-bbox="815 315 1458 546"> Since cages are made of low hardness materials, external pressure and contact with other parts can easily produce flaws and distortion. In some cases, these are aggravated and become chipping and cracks. Large chipping and cracks are often accompanied by deformation, which may reduce the accuracy of the cage itself and may hinder the smooth movement of rolling elements. </p>	
(8) Seizure	 <p data-bbox="815 1055 1458 1111"> A phenomenon caused by abnormal heating in bearings due to some reasons </p>	

Damages	Causes	Countermeasures
<p>Flaws, distortion, chipping, cracking and excessive wear in cages.</p>	<ul style="list-style-type: none"> · Extraordinary vibration, impact, moment · Improper or insufficient lubricant · Dents made during mounting 	<ul style="list-style-type: none"> · Re-examine load conditions. · Select proper lubricating method or lubricant. · Re-examine cage types. · Improve mounting.
<p>Discoloration, distortion, and melting together due to heating in bearings</p>	<ul style="list-style-type: none"> · Too small internal clearance · Improper or insufficient lubricant · Excessive load · Aggravated by other bearing flaws 	<ul style="list-style-type: none"> · Provide proper internal clearance. · Select proper lubricating method or lubricant. · Re-examine bearing type. · Earlier discovery of bearing flaws

Specification tables of needle roller bearings



Needle roller and cage assemblies

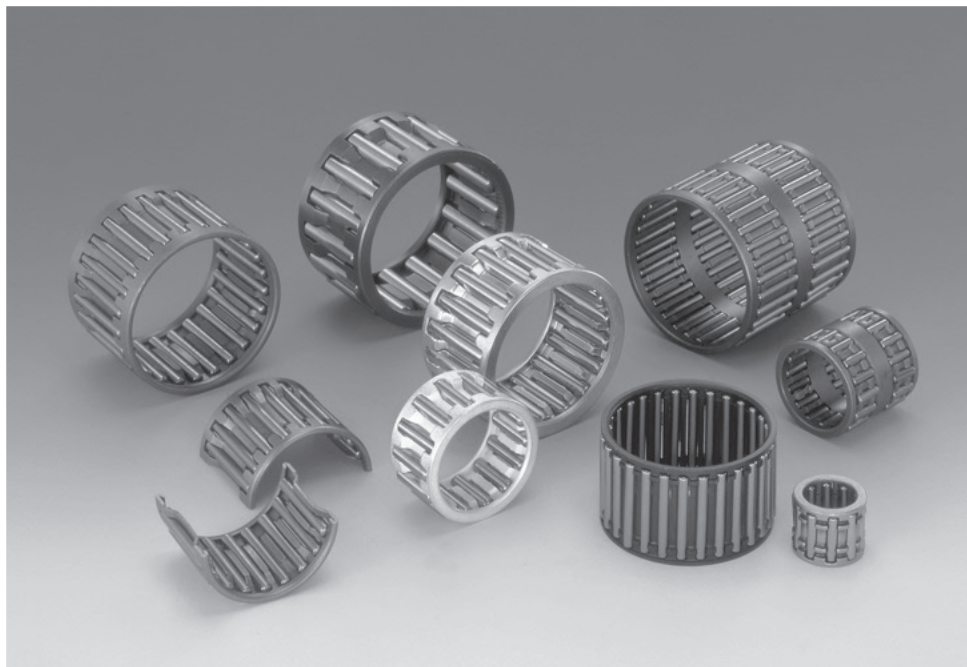

NEEDLE
ROLLER
BEARINGS

Needle roller and cage assemblies

The Koyo needle roller and cage assemblies have a cage which is specially designed to retain and to guide rollers accurately.

After heat treatment, the roller, made of high carbon chromium bearing steel, is ground and crowned.

■ Inner and outer rings are not needed.

When the shaft and housing are highly accurate and hard enough to serve as the bearing raceway, inner and outer rings are not required so that the structure around the bearing can be simplified.

1 Bearing number

(Ex. 1)

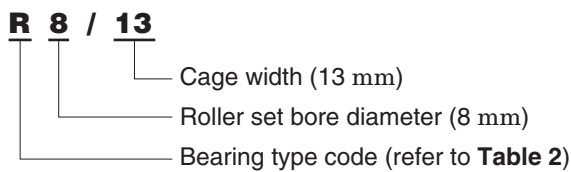

(Ex. 3)

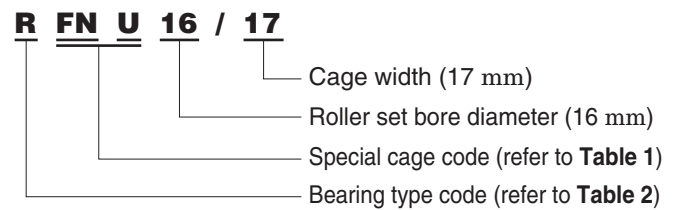

(Ex. 2)

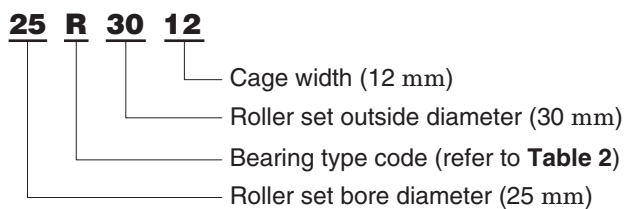

Table 1 Special cage code

Code	Description
F, FN	With polyamide cage
U	With double split cage

Table 2 Type code of needle roller and cage assemblies

Type	Single-row			Double-row		
Type code	RS, R, RP	RV, V, VS	VP, VPS	WR, WRS	WRP	WV

[Note] 1) Concerning the needle roller and cage assembly used for connecting rods, refer to page 60.

2 Tolerances

The tolerances of needle roller used for the Koyo needle roller and cage assembly are as specified in JIS B 1506. (refer to page 177)

Table 3 shows the tolerances of cage width (B_c) to the standard item (conform to JIS B 1536-3).

Table 3 Tolerance of cage width B_c

Bearing type	Cage width deviation ΔB_{cs}	
	upper	lower
RS, R, RP (Welded type), RV, V, VS, WR, WRS, WRP, WV	-0.2	-0.55
VP, VPS, RP	<i>-0.2</i>	<i>-0.7</i>

[Remark] Values in Italics are prescribed in JTEKT standards.

3 Shaft and housing

The needle roller and cage assembly generally uses the shaft and housing as the raceway ring; and therefore they are required to satisfy the specifications shown in **Table 4**.

In addition, the dimensional tolerance of the guide width (b) of Koyo needle roller and cage assembly is recommended to $b = B_c^{+0.2}$ in relation to cage width (B_c). (refer to **Fig. 1**)

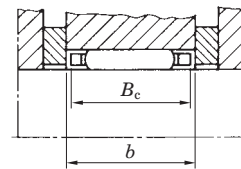

Fig. 1

Table 4 Specifications of shafts and housings

	Shaft (Raceway surface)	Housing bore (Raceway surface)
Roundness	Best if less than one half or one third of the shaft diameter (housing bore diameter) tolerance	
Cylindricity	5 μm or less per 25 mm, or one half or less of the shaft diameter (housing bore diameter) tolerance	
Roughness (Ra)	0.4 a or less	0.6 a or less
Hardness¹⁾	58 HRC or harder (60 to 64 HRC are best.)	
Shaft Slope	13 μm or less per 25 mm	

[Note] 1) Case hardened steel which is carburized or induction-hardened should not only meet the surface hardness requirement specified above but also have a case depth of 52.3 HRC (550 HV) to a depth in the range $(0.08 \text{ to } 0.1) \times D_w$ mm. (D_w : roller diameter)
In general, 30 thru 45 HRC is best for the center hardness.

4 Fits

The recommended fits of the Koyo needle roller and cage assembly are shown in **Table 5**.

Table 5 Recommended fit

Conditions	Tolerance class		
	Shaft		Housing bore
	$F_w \leq 50 \text{ mm}$	$F_w > 50 \text{ mm}$	
High accuracy, impact load, oscillating motion	js5	h5	G6
General	h5	g5	
High temperature, large shaft deflection, large misalignment	f6		

5 Inspection

Radial needle roller and cage assemblies should be inspected in accordance with the procedures specified in JIS B 1515-2. **Table 6** shows the inspecting gauge specifications specified in JIS B 1536-3.

Table 6 Inspecting gauge specifications

Unit : mm

E_w		Inspecting gauge specifications	
over	up to	Plug gauge specifications for roller set bore diameter	Ring gauge specifications for roller set outside diameter
—	6	Same as F_w	$E_w + 0.004$
6	10		$E_w + 0.005$
10	18		$E_w + 0.006$
18	30		$E_w + 0.007$
30	50		$E_w + 0.009$
50	80		$E_w + 0.010$
80	120		$E_w + 0.012$

[Note] 1) In the ring gauge specifications for roller set outside diameter, values added to E_w are the same as the lower tolerances of G6 tolerance class of JIS B 0401-2.

Needle roller and cage assemblies

Single-row
 F_w 9 ~ (15) mm

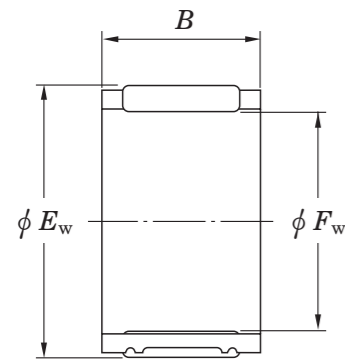

RS, R, RP

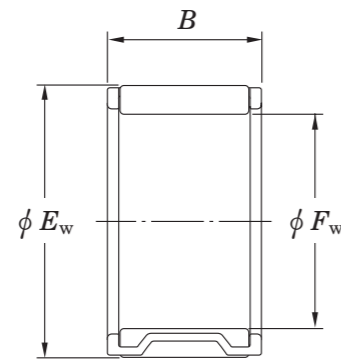

RV, V, VS

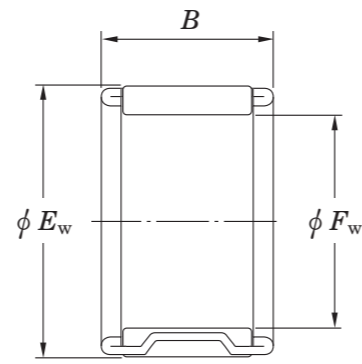

VP, VPS

F_w (15) ~ (20) mm

ϕE_w : Roller set outside diameter

ϕF_w : Roller set bore diameter

Boundary dimensions (mm)			Basic load ratings (kN)		Limiting speeds (min ⁻¹)	Bearing No.	Specification (Cage)	(Refer.) Mass (g)
F_w	E_w	B	C_r	C_{0r}	Oil lub.			
9	12	10	3.8	4.0	43 000	RS091210	—	2.9
	14	18	9.1	9.0	41 000	RF091418	Polyamide	5.3
10	13	13	5.8	7.0	41 000	R10/13	—	4.0
	13	20	5.0	5.8	41 000	RF101320	Polyamide	2.4
	14	8	4.5	4.3	40 000	RS10/8-1	—	3.5
	14	10	5.1	5.0	40 000	RS10/10	—	4.3
	14	13	7.0	7.4	40 000	RS10/13	—	5.5
	15	18	10.5	10.9	37 000	RP101518	Welded	7.8
12	15	13	6.3	8.2	36 000	R12/13	—	4.7
	16	20	9.5	11.5	35 000	12R1620A	—	10
	17	11.5	8.2	8.3	34 000	RV121712A-2	—	6.6
13	17	10	5.9	6.4	33 000	RS131710-2	—	5.5
	17	12	7.3	8.4	33 000	RS131712	—	6.5
	18	15	10.2	11.2	32 000	13R1815	—	10
14	18	10	5.8	6.5	31 000	RS141810Q2	—	6.0
	18	15	9.6	12.3	31 000	RS141815	—	8.5
	18	17	10.1	13.2	31 000	R14/17A	—	10
	19	9	7.0	7.1	30 000	RV141909P1	—	5.7
	19	18	12.3	14.6	30 000	RS141918	—	13
15	19	7.8	4.7	5.0	29 000	RS151908A	—	5.0
	19	10	6.3	7.2	29 000	R15/10-1	—	6.1
	19	13	8.7	10.9	29 000	R15/13	—	7.9
	19	17	10.5	14.0	29 000	R15/17	—	10
	19	20	12.6	17.7	29 000	R15/20	—	12
	20	13	10.4	11.9	29 000	VS15/13	—	8.6
	20	18	13.8	17.2	29 000	RS15/18A	—	14
	20	20	16.2	21.2	29 000	VS15/20	—	12

[Note] 1) For further information, consult with JTEKT.

[Remark] Limiting speed of grease lubrication should be kept to under 60 % of that for oil lubrication.

Boundary dimensions (mm)			Basic load ratings (kN)		Limiting speeds (min ⁻¹)	Bearing No.	Specification (Cage)	(Refer.) Mass (g)
F_w	E_w	B	C_r	C_{0r}	Oil lub.			
15	21	9	7.4	6.9	28 000	RV152109-4	—	7.8
	21	17	13.4	14.8	28 000	RS152117	—	16
16	20	13	9.4	12.5	28 000	R16/13	Width tolerance special ¹⁾	8.5
	21	26	19.9	28.0	27 000	16VP2126	Width tolerance special ¹⁾	16
	22	12	9.6	9.6	26 000	16VS2212-2	—	11
	22	24	20.4	25.6	26 000	RS16/24	Width tolerance special ¹⁾	23
	22	28.4	21.7	27.9	26 000	VPS16/28A	—	24
17	20	6	3.1	3.6	27 000	RF172006	With single split polyamide	1.3
	20	8	3.8	4.7	27 000	RF172008A-2	With single split polyamide	1.7
	21	10	6.8	8.3	26 000	R17/10	—	6.8
	21	13	9.4	12.6	26 000	R17/13	—	8.8
	21	15	10.7	15.0	26 000	R17/15	—	10
	21	17	11.3	16.1	26 000	RS172117	—	11
	22	20	15.2	20.2	26 000	17R2220	—	17
	23	13	11.4	12.4	25 000	RS17/13	—	14
18	22	13	9.5	13.1	25 000	R18/13	—	9.2
	22	16	11.1	16.0	25 000	R18/16-8	—	11
	22	17	11.9	17.4	25 000	R18/17	—	12
	24	17	15.1	17.9	24 000	RS182417	Width tolerance special ¹⁾	19
	25	17	17.8	20.1	23 000	RP182517	Welded	19
	26	21.9	19.1	20.3	23 000	RF182622A-1	Polyamide	19
	26	21.9	22.7	25.5	23 000	RV182622A-2	—	31
19	24	22	16.6	23.3	23 000	RS192422	—	21
20	24	10	7.2	9.4	23 000	R20/10	—	7.9
	24	13	9.8	14.0	23 000	R20/13P	—	10
	25	25	18.8	27.9	22 000	RF202525	Polyamide	14

Needle roller and cage assemblies

Single-row

F_w (20) ~ (22) mm

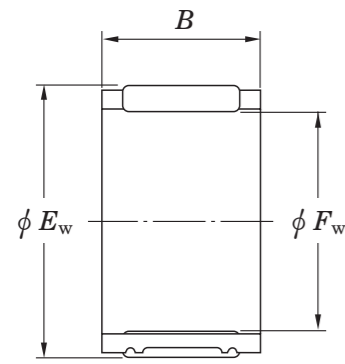

RS, R, RP

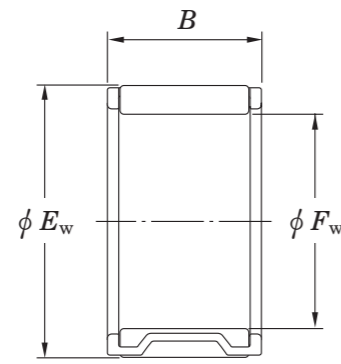

RV, V, VS

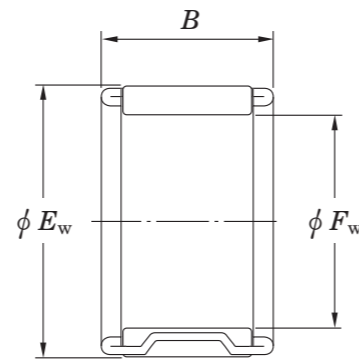

VP, VPS

F_w (22) ~ (25) mm

ϕE_w : Roller set outside diameter

ϕF_w : Roller set bore diameter

Boundary dimensions (mm)			Basic load ratings (kN)		Limiting speeds (min ⁻¹)	Bearing No.	Specification (Cage)	(Refer.) Mass (g)
F_w	E_w	B	C_r	C_{0r}	Oil lub.			
20	26	11.6	10.7	11.9	22 000	20VS2612	Width tolerance special ¹⁾	12
	26	12	12.8	15.1	22 000	RV202612-4	—	14
	26	14	14.1	17.0	22 000	VS20/14A	—	15
	26	17	15.8	19.6	22 000	RS20/17	—	21
	26	18.8	17.4	22.3	22 000	RP202619A	—	17
	26	20	18.9	24.7	22 000	VP20/20-1	Width tolerance special ¹⁾	19
	26	30	26.8	38.9	22 000	RS202630	Welded	39
	27	15	16.2	18.3	21 000	20V2715	—	19
	27	29	25.4	32.6	21 000	20V2729	—	37
	28	20	24.1	28.2	21 000	RP202820	—	28
	28	25	28.8	35.4	21 000	20V2825B	—	37
	30	15	18.2	17.1	20 000	RV203015	—	30
21	29	22.5	23.7	27.6	20 000	RF212923A	Polyamide	24
22	26	12	9.6	14.1	21 000	RS222612	—	10
	26	13	10.4	15.6	21 000	R22/13-1	—	11
	26	17	13.0	20.7	21 000	R22/17	—	14
	27	20	17.0	25.2	20 000	RS222720	—	21
	28	11	9.5	10.5	20 000	RS222811	—	15
	28	14	13.2	15.9	20 000	22VS2814E	—	16
	28	17	16.1	20.7	20 000	RS22/17	—	22
	28	22.5	21.3	29.6	20 000	RP222823A	Welded, Width tolerance special ¹⁾	25
	28	23	24.2	35.1	20 000	VS22/23B	Width tolerance special ¹⁾	25
	29	17	17.0	20.0	20 000	RV222917	—	23
	30	15	16.7	17.9	19 000	RV223015	—	25
	30	18	21.8	25.2	19 000	RV223018	—	30
	30	20	24.1	28.8	19 000	RV223020-1	—	31
	32	15	21.1	21.3	19 000	RV223215	—	32
	32	16	21.1	21.3	19 000	RV223216	—	35

[Note] 1) For further information, consult with JTEKT.

[Remark] Limiting speed of grease lubrication should be kept to under 60 % of that for oil lubrication.

Boundary dimensions (mm)			Basic load ratings (kN)		Limiting speeds (min ⁻¹)	Bearing No.	Specification (Cage)	(Refer.) Mass (g)
F_w	E_w	B	C_r	C_{0r}	Oil lub.			
22	32	30	40.4	48.9	19 000	RV223230	—	62
23	29	30	26.0	39.0	19 000	23V2930	Width tolerance special ¹⁾	35
	30	15	17.4	21.0	19 000	RV233015	—	21
	33	20	27.0	29.4	18 000	23V3320-1	Width tolerance special ¹⁾	44
24	28	13	11.1	17.4	19 000	RS242813	—	12
	28	17	13.7	22.8	19 000	R24/17A	—	16
	28	23	18.2	32.9	19 000	RS242823	—	21
	32	15	20.0	23.2	18 000	RV243215-4	—	27
25	29	9.9	7.1	9.8	19 000	R25/10A	Width tolerance special ¹⁾	10
	29	13	11.5	18.4	19 000	R25/13-1	—	13
	30	9.9	9.3	12.0	18 000	25R3010A	Width tolerance special ¹⁾	13
	30	12	10.5	14.1	18 000	25R3012	—	15
	30	17	15.7	23.6	18 000	25V3017	—	18
	30	20	19.0	30.1	18 000	25R3020-1	—	24
	30	20	16.6	25.3	18 000	25VPU3020B	Double split	16
	31	17.5	17.4	23.8	18 000	VPS25/18	—	18
	31	18	17.4	23.8	18 000	RS25/18	—	27
	31	20	21.0	30.5	18 000	VS25/20	Width tolerance special ¹⁾	26
	31	24	24.9	37.8	18 000	25R3124	—	35
	32	16	18.9	23.8	18 000	25V3216	—	25
	32	24	26.4	36.7	18 000	RS253224	—	43
	32	32	37.8	58.4	18 000	RPU253232F-1	Double split	51
	32	32	39.6	62.0	18 000	RV253232	—	49
33	20	24.1	29.8	17 000	RV253320	—	35	
33	23.8	30.2	40.0	17 000	25R3324B-1	Width tolerance special ¹⁾	48	
33	30	38.6	54.8	17 000	RF253330	Polyamide	41	
35	25	32.5	38.0	17 000	25R3525	—	65	
35	30	39.6	49.0	17 000	25V3530A	—	69	

Needle roller and cage assemblies

Single-row
F_w (25) ~ (30) mm

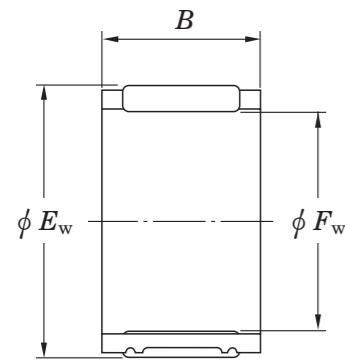

RS, R, RP

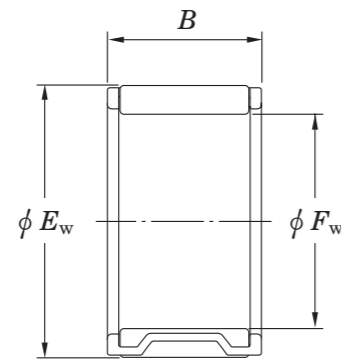

RV, V, VS

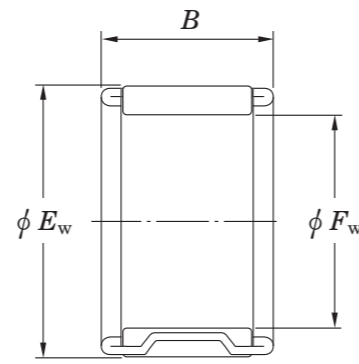

VP, VPS

F_w (30) ~ (32) mm

φ E_w : Roller set outside diameter

φ F_w : Roller set bore diameter

Boundary dimensions (mm)			Basic load ratings (kN)		Limiting speeds (min ⁻¹)	Bearing No.	Specification (Cage)	(Refer.) Mass (g)
F _w	E _w	B	C _r	C _{0r}	Oil lub.			
25	37	24	34.1	36.2	16 000	25V3724	—	69
	37	25	38.3	42.2	16 000	25V3725A	—	77
	37	33	47.5	55.7	16 000	RV253733	—	96
26	30	20	16.9	30.6	18 000	RS263020	—	20
	30	21.9	16.9	30.4	18 000	RS263022A	—	22
	31	16	15.7	23.8	18 000	RS263116	—	20
	31	19	18.5	29.5	18 000	RS263119	—	24
	33	34	30.4	44.0	17 000	RPU263334F	Double split	42
	34	17	23.9	30.0	17 000	RV263417	—	32
27	32	27	26.2	46.6	17 000	RFN27/27	Polyamide, Width tolerance special ¹⁾	20
	33	28.6	30.0	49.2	17 000	VPSU27/29AF	Double split	33
28	32	26	17.1	31.5	17 000	28R3226	—	27
	32	29	17.1	31.5	17 000	28R3229	—	32
	33	17	17.9	29.0	16 000	28R3317	—	22
	33	23	22.8	39.6	16 000	R28/23A	—	31
	33	27	25.0	44.5	16 000	R28/27	—	36
	36	20	23.2	29.3	16 000	28R3620	—	45
	38	24	31.2	37.1	15 000	RS283824	—	70
	40	28	49.1	59.5	15 000	RV284028	—	90
	41	25	40.2	43.6	14 000	RV284125	—	86
	42	50.5	88.9	116.5	14 000	RF284251A	Polyamide	182
29	34	22	17.3	27.6	16 000	R29/22A	—	30
	34	24.4	19.7	32.8	16 000	RFU293424A	With double split polyamide	17
	34	27	25.7	46.7	16 000	29R3427A-1	—	37
	43	43	73.7	92.2	14 000	RV294343	—	177
30	34	14	7.7	11.4	16 000	30R3414A	—	16
	34	14	7.7	11.5	16 000	RFN303414	Polyamide	6.1

Boundary dimensions (mm)			Basic load ratings (kN)		Limiting speeds (min ⁻¹)	Bearing No.	Specification (Cage)	(Refer.) Mass (g)
F _w	E _w	B	C _r	C _{0r}	Oil lub.			
30	34	29	18.1	34.8	16 000	30R3429	—	34
	34	29	20.4	40.8	16 000	RSU303429	Double split	33
	35	17	17.7	29.2	15 000	R30/17-1	—	24
	35	21.1	22.2	39.0	15 000	RS303521A	—	30
	35	24	24.9	45.1	15 000	RS303524	—	34
	37	16	21.8	30.3	15 000	RV303716	—	29
	37	20	25.2	36.6	15 000	RS30/20A	—	41
	37	26	34.7	55.3	15 000	RV303726	—	47
	38	22.1	27.7	37.5	15 000	RP303822A	Welded	45
	38	28.3	33.5	47.8	15 000	RPU303828AF	Double split	47
	39	27	34.2	45.6	14 000	RP303927	—	51
	39	30	38.3	52.8	14 000	30VP3930A	Width tolerance special ¹⁾	58
	39	32	42.6	60.5	14 000	RP303932	Welded, Width tolerance special ¹⁾	63
	40	15.5	26.7	31.1	14 000	RV304016A-4	—	46
	40	20	32.0	39.1	14 000	30V4020	—	55
42	15	27.0	28.0	14 000	RF304215	Polyamide	36	
42	25	44.0	52.3	14 000	RV304225	—	84	
42	32	52.7	66.0	14 000	30V4232	Width tolerance special ¹⁾	108	
45	30	54.4	60.2	13 000	30V4530	—	135	
31	36	20.3	19.9	34.2	15 000	RFU313620A-1	With double split polyamide	17
32	36	15	10.8	18.3	15 000	32R3615A	—	19
	37	17	19.0	32.6	14 000	R32/17-1	—	26
	37	20	22.3	39.9	14 000	R32/20	—	30
	37	23.8	22.6	40.5	14 000	RF323724A-1	With single split polyamide	20
	37	26	26.2	49.0	14 000	RF323726	Polyamide, Width tolerance special ¹⁾	24
	37	29.5	31.1	61.2	14 000	VP32/30A	—	32
	38	20	24.9	40.6	14 000	32VP3820A	Welded	27
	38	26	27.3	45.6	14 000	RP323826	Width tolerance special ¹⁾	34

[Note] 1) For further information, consult with JTEKT.

[Remark] Limiting speed of grease lubrication should be kept to under 60 % of that for oil lubrication.

Needle roller and cage assemblies

Single-row

F_w (32) ~ (35) mm

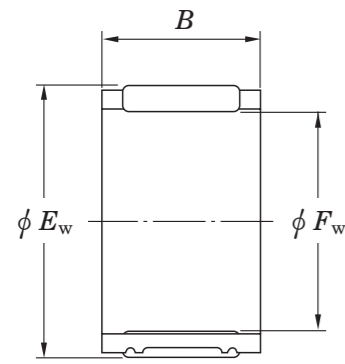

RS, R, RP

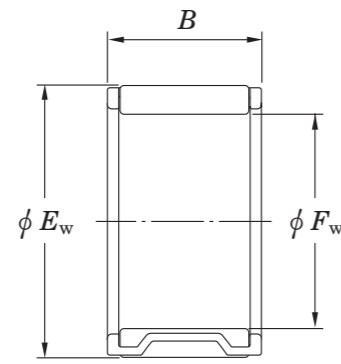

RV, V, VS

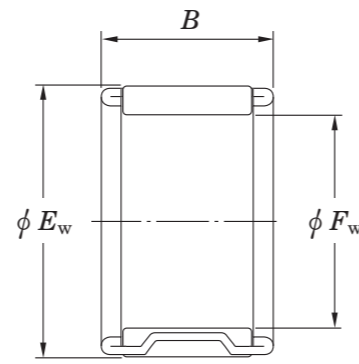

VP, VPS

F_w (35) ~ (38) mm

ϕE_w : Roller set outside diameter

ϕF_w : Roller set bore diameter

Boundary dimensions (mm)			Basic load ratings (kN)		Limiting speeds (min ⁻¹) Oil lub.	Bearing No.	Specification (Cage)	(Refer.) Mass (g)
F_w	E_w	B	C_r	C_{0r}				
32	38	27	29.6	50.7	14 000	32VP3827	Width tolerance special ¹⁾	38
	39	16	21.2	29.8	14 000	RS323916	—	35
	42	16	27.5	32.9	14 000	RV324216	—	49
	42	20.5	33.5	42.2	14 000	RV324221-1	—	64
	45	28	47.9	56.5	13 000	32V4528	—	112
	46	18	37.0	38.8	13 000	RF324618	Polyamide	57
	46	18	30.3	29.8	13 000	RV324618-1	—	71
33	37	22	18.5	37.2	14 000	RSU333722F	Double split	27
34	39	20.3	19.6	34.4	14 000	RFU343920A	With double split polyamide	18
	42	38	49.2	81.9	13 000	34R4238	Width tolerance special ¹⁾	98
	44	40	64.1	99.1	13 000	34VP4440-1	—	101
35	39	25	22.0	47.4	14 000	RF353925	With single split polyamide	24
	40	13	14.2	23.0	13 000	RS354013	—	22
	40	17	18.4	32.0	13 000	RS354017	—	29
	40	22	23.6	44.4	13 000	RS354022	—	37
	40	24	25.9	49.9	13 000	RS354024	—	39
	40	24.8	23.7	44.4	13 000	RSU354025AF	Double split	39
	40	25	27.0	52.7	13 000	RS354025-1	—	41
	40	26	28.7	56.9	13 000	RS354026	—	41
	40	28	28.7	56.9	13 000	RF354028	Polyamide	27
	40	29	30.6	61.7	13 000	RP354029-1	Width tolerance special ¹⁾	33
	40	30	30.6	61.7	13 000	VP35/30	—	34
	40	31	30.6	61.6	13 000	RP354031	Welded, Width tolerance special ¹⁾	37
	40	33	31.1	63.2	13 000	RP354033-1	—	39
	40	35	31.8	64.9	13 000	RF354035	Polyamide	32
	41	35	40.4	78.0	13 000	35VP4135A	—	51
	41	40	42.4	82.6	13 000	35VP4140A	—	59

[Note] 1) For further information, consult with JTEKT.

[Remark] Limiting speed of grease lubrication should be kept to under 60 % of that for oil lubrication.

Boundary dimensions (mm)			Basic load ratings (kN)		Limiting speeds (min ⁻¹) Oil lub.	Bearing No.	Specification (Cage)	(Refer.) Mass (g)
F_w	E_w	B	C_r	C_{0r}				
35	42	20	27.2	42.0	13 000	VS35/20	—	42
	42	30	39.9	68.8	13 000	VS35/30	Width tolerance special ¹⁾	59
	48	17.5	37.8	42.7	12 000	RV354818A-4	—	81
	49	25	53.4	63.4	12 000	RV354925-1	—	120
36	40	10	9.6	16.5	13 000	36R4010	—	14
	41	20	21.7	40.3	13 000	RS364120	—	34
	41	25	29.9	60.6	13 000	36RFN4125A	Polyamide	27
	41	30.5	33.1	69.2	13 000	R36/31	—	51
	42	17	20.5	32.8	13 000	RS364217-K	—	35
	42	19	23.2	38.6	13 000	RS364219-K	—	39
	42	21	25.9	44.4	13 000	RS364221-K	—	44
	42	25	33.1	60.9	13 000	RF364225-1	Polyamide	34
	48	25	54.0	71.7	12 000	RF364825-1	Polyamide	80
	52	30	73.9	89.9	11 000	RF365230	Polyamide	139
37	42	11.6	11.3	17.5	13 000	RS374212A	—	23
	42	12.8	14.0	23.2	13 000	VP37/13A	Width tolerance special ¹⁾	14
	42	17.3	21.3	39.7	13 000	VP37/17	Width tolerance special ¹⁾	21
	42	22	24.0	46.3	13 000	37R4222	—	38
	42	23	23.8	45.5	13 000	RF374223-1	With single split polyamide	22
	42	27	30.8	63.6	13 000	RS374227	—	46
	42	27	30.0	61.5	13 000	RSU374227	Double split	45
	42	29	31.9	66.5	13 000	VP37/29	—	35
	42	31	33.9	72.1	13 000	RS374231	Welded	52
	42	32	31.2	64.3	13 000	VP37/32	—	37
	43	32	39.1	75.8	13 000	37R4332	—	66
	43	36.8	40.0	77.9	13 000	RPU374337F	Double split	60
38	42	10	8.9	15.2	13 000	RF384210	Polyamide	6.6

Needle roller and cage assemblies

Single-row
F_w (38) ~ (42) mm

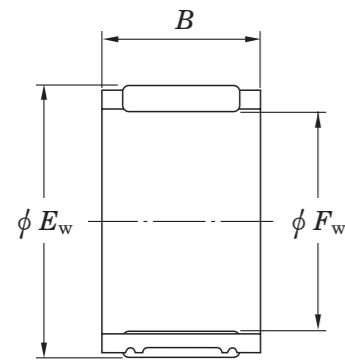

RS, R, RP

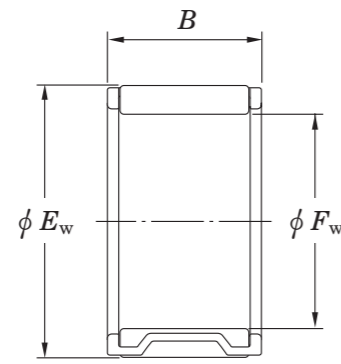

RV, V, VS

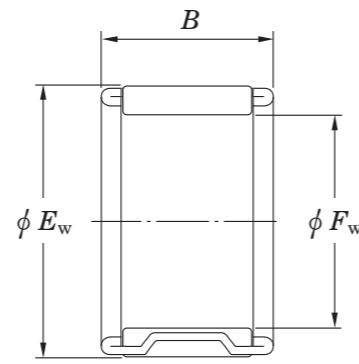

VP, VPS

F_w (42) ~ (45) mm

φ E_w : Roller set outside diameter

φ F_w : Roller set bore diameter

Boundary dimensions (mm)			Basic load ratings (kN)		Limiting speeds (min ⁻¹) Oil lub.	Bearing No.	Specification (Cage)	(Refer.) Mass (g)
F _w	E _w	B	C _r	C _{0r}				
38	44	23.4	25.1	43.1	12 000	RF384423A	Polyamide	26
	44	24.5	27.5	48.4	12 000	RSU384425AF	Double split	51
	44	26	28.7	51.1	12 000	RF384426	Polyamide	29
	44	33	37.9	73.4	12 000	RP384433	—	64
	44	36.2	39.9	78.1	12 000	RP384436A	—	57
	44	39.8	43.7	88.1	12 000	RP384440A	—	65
	52	39	74.8	99.2	11 000	RP385239	—	155
39	46	32.8	42.4	76.9	12 000	39R4633	—	82
	55	20.5	55.0	62.6	11 000	RF395521A	Polyamide	98
	59	23	63.8	66.3	10 000	RV395923-1	—	196
40	45	13	17.1	30.8	12 000	RV404513	—	22
	45	17	19.9	37.4	12 000	R40/17-1	—	32
	45	21.2	23.6	46.6	12 000	RS404521A	—	40
	45	27	29.9	63.0	12 000	RS404527	—	49
	45	30	30.5	64.4	12 000	R40/30	—	55
	45	32	14.3	23.3	12 000	R40/32A	—	53
	46	14.5	21.2	35.5	12 000	RP404615A	Welded	31
	46	29	36.4	70.6	12 000	RS404629	—	65
	47	20	27.6	44.8	11 000	RS40/20	—	54
	47	28.5	38.0	67.6	11 000	RS40/29A	—	77
	48	34	50.4	88.3	11 000	40V4834	—	87
	55	27.5	68.0	85.6	11 000	RF405528A-1	Polyamide	124
	56	20	50.8	56.7	10 000	RV405620-4	—	122
	57	31.5	83.4	103	10 000	RF405732A	Polyamide	168
60	31.5	94.1	110	10 000	RF406032A	Polyamide	214	
41	46	24	11.0	16.8	11 000	41R4624A	—	44
42	47	10	13.9	23.8	11 000	RS424710-1	Welded	21

Boundary dimensions (mm)			Basic load ratings (kN)		Limiting speeds (min ⁻¹) Oil lub.	Bearing No.	Specification (Cage)	(Refer.) Mass (g)
F _w	E _w	B	C _r	C _{0r}				
42	47	25	29.5	63.1	11 000	RS424725	—	52
	47	27	32.3	70.8	11 000	RS424727	—	51
	47	30	31.9	69.8	11 000	RSU424730	Double split	58
	47	30	36.3	82.4	11 000	VP42/30	—	44
	49	22	29.3	49.0	11 000	RF424922	Polyamide	35
43	48	18	21.9	43.2	11 000	RS434818	—	36
	48	18.5	22.1	43.7	11 000	RS434819A-2	—	38
	48	21.2	25.0	51.5	11 000	RS434821A	—	46
	48	23.3	29.4	63.2	11 000	RS434823A	—	46
	48	24.4	28.2	59.9	11 000	RS434824A	—	49
	48	30	34.1	76.5	11 000	RS434830	Welded	58
	49	31	40.1	82.5	11 000	43VP4931E	—	55
44	50	27.5	36.0	72.2	11 000	44RFN5028	Polyamide	39
	50	39	46.4	100	11 000	RP445039	—	71
45	50	13	16.0	29.4	11 000	R45/13	—	28
	50	17	22.7	46.1	11 000	RS455017	—	35
	50	19	24.1	49.7	11 000	R45/19	—	39
	50	20.2	24.1	49.6	11 000	RS455020A	—	46
	50	24	29.3	63.9	11 000	RS455024	—	50
	50	26	31.8	70.9	11 000	R45/26	—	54
	50	33	37.3	87.0	11 000	RS455033-1	—	69
	51	28.6	34.1	67.7	10 000	45RFN5129	Polyamide	40
	51	28.9	37.5	76.9	10 000	RP455129A	Welded	65
	51	28.9	37.5	76.9	10 000	RPU455129AF	Double split	67
	52	22	35.4	63.9	10 000	RS455222	—	66
	53	25	41.4	71.1	10 000	RV455325P	—	73

[Note] 1) For further information, consult with JTEKT.

[Remark] Limiting speed of grease lubrication should be kept to under 60 % of that for oil lubrication.

Needle roller and cage assemblies

Single-row
F_w (45) ~ (50) mm

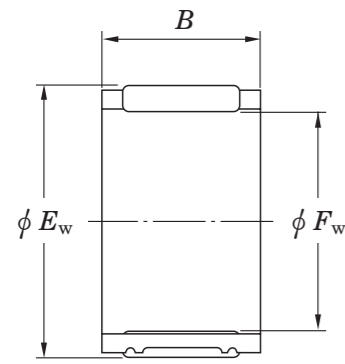

RS, R, RP

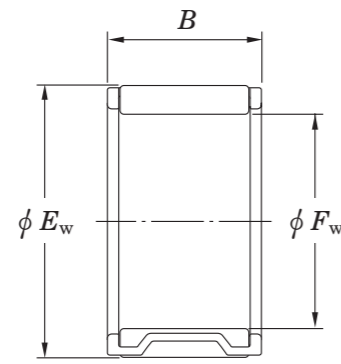

RV, V, VS

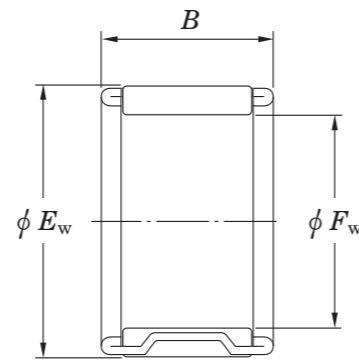

VP, VPS

F_w (50) ~ 58 mm

φ E_w : Roller set outside diameter

φ F_w : Roller set bore diameter

Boundary dimensions (mm)			Basic load ratings (kN)		Limiting speeds (min ⁻¹)	Bearing No.	Specification (Cage)	(Refer.) Mass (g)
F _w	E _w	B	C _r	C _{0r}	Oil lub.			
45	53	26	41.4	71.1	10 000	45V5326P	—	77
	53	28	42.3	73.2	10 000	45VP5328	Width tolerance special ¹⁾	66
	64	23	64.0	70.4	9 200	RV456423-7	—	191
46	52	20	25.9	48.2	10 000	46VP5220	—	34
	52	37	45.8	100	10 000	46VP5237B	—	67
47	52	30	36.4	85.4	10 000	R47/30H	—	62
	52	30	35.1	81.7	10 000	RSU475230F-1	Double split	62
	53	28.8	35.3	72.3	10 000	RP475329A	—	55
	53	30	42.6	92.1	10 000	RP475330-1	Welded	74
	53	36	47.0	104	10 000	RP475336	—	68
48	53	13	16.1	30.1	9 900	RS485313	—	30
	53	28	34.1	79.2	9 900	48R5328	—	60
	54	20	29.3	57.3	9 800	48R5420-1	—	54
	54	27	38.1	80.4	9 800	48R5427	—	72
	54	28	37.8	79.3	9 800	RS485428	Welded	72
	54	29	39.5	84.3	9 800	48R5429	—	78
	54	30.2	43.8	96.2	9 800	RP485430A-1	Welded	72
	54	39	47.9	108	9 800	48R5439	—	106
	55	21	32.4	58.1	9 700	RP485521	Welded	60
49	56	44.6	61.2	133	9 500	RP495645A	Welded	120
	56	44.6	61.2	133	9 500	RS495645A	—	146
50	55	17.5	22.3	46.5	9 500	RS505518A	Welded	39
	55	20	25.1	54.3	9 500	RS505520-1	—	47
	55	27	11.5	18.9	9 500	R50/27A	—	56
	56	13	16.7	28.2	9 400	RF505613	Polyamide	18
	56	28	39.5	85.5	9 400	RP505628	Welded	69
	56	30	41.0	89.6	9 400	RF505630	Polyamide	50

[Note] 1) For further information, consult with JTEKT.

[Remark] Limiting speed of grease lubrication should be kept to under 60 % of that for oil lubrication.

Boundary dimensions (mm)			Basic load ratings (kN)		Limiting speeds (min ⁻¹)	Bearing No.	Specification (Cage)	(Refer.) Mass (g)
F _w	E _w	B	C _r	C _{0r}	Oil lub.			
50	57	33.5	47.8	97.1	9 300	RP505734A	—	79
	57	38.9	58.3	126	9 300	RS505739A	—	133
	57	40.8	60.9	133	9 300	RS505741A	—	127
	58	25	38.5	66.9	9 300	RF505825	Polyamide	53
	70	36	114	147	8 300	RF507036	Polyamide	277
51	56	28	34.8	83.0	9 300	VP51/28	—	45
52	72	32	108	138	8 100	RF527232	Polyamide	259
53	58	25	32.2	76.0	9 000	RF535825	Polyamide	35
54	60	31.1	45.3	104	8 800	RP546031A	Welded	83
	60	36	45.5	105	8 800	RP546036	Welded, Width tolerance special ¹⁾	82
	61	34.7	60.2	135	8 700	RPU546135AF	Double split	116
	61	41.3	63.3	143	8 700	RS546141A	—	145
55	59	13	10.8	21.9	8 800	55RFN5913A	Polyamide	11
	60	20	26.7	60.6	8 700	R55/20	—	52
	60	28	35.8	88.4	8 700	RS556028	—	69
56	60	20	24.0	62.4	8 600	RF566020	Polyamide	23
	61	11	13.6	25.6	8 500	RF566111	Polyamide	14
	61	30	39.7	102	8 500	RS566130	Welded	75
	61	33.5	42.5	111	8 500	R56/34	—	85
58	65	26	42.1	87.1	8 100	58R6526	Width tolerance special ¹⁾	99
	65	36.6	55.7	125	8 100	58RFN6537A	Polyamide	80
	65	36.6	56.4	127	8 100	RS586537A-2	—	145
	65	37.5	57.7	131	8 100	RP586538A	Welded, Width tolerance special ¹⁾	108
	80	72	233	359	7 200	RV588072	—	889

Needle roller and cage assemblies

Single-row

F_w 60 ~ 78 mm

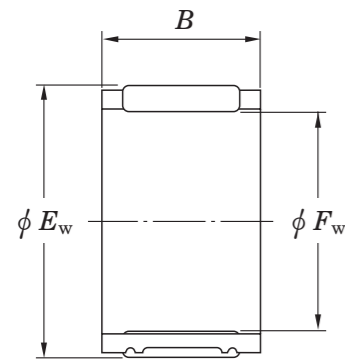

RS, R, RP

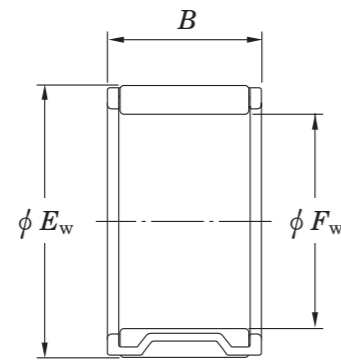

RV, V, VS

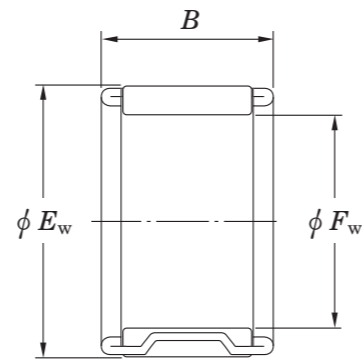

VP, VPS

ϕE_w : Roller set outside diameter

ϕF_w : Roller set bore diameter

Boundary dimensions (mm)			Basic load ratings (kN)		Limiting speeds (min ⁻¹) Oil lub.	Bearing No.	Specification (Cage)	(Refer.) Mass (g)
F_w	E_w	B	C_r	C_{0r}				
60	65	30	40.0	105	8 000	R60/30	—	81
	66	19	31.5	67.8	7 900	RS606619	—	63
	67	23	40.1	82.8	7 900	60V6723	—	77
	82	30	118	152	7 000	RF608230	Polyamide	316
63	68	30	40.9	110	7 600	R63/30	—	83
64	70	24.5	39.4	92.4	7 500	64R7025A	—	86
	70	35	55.7	144	7 500	64R7035	—	122
65	70	20	12.1	22.3	7 400	R65/20A	—	57
	70	24	12.5	22.9	7 400	R65/24A	—	67
70	76	20	34.7	80.8	6 800	70R7620	—	77
	76	32	55.1	147	6 800	RP707632	Welded	116
	78	30	59.4	132	6 800	70R7830	—	154
71	79	30.15	61.3	138	6 700	71V7930B	—	135
	79	39.5	75.3	179	6 700	RS717940AZ	—	203
72	79	21	39.6	86.6	6 600	72V7921	—	84
73	79	20	36.3	86.8	6 600	R73/20	—	84
78	85	33.75	62.3	159	6 100	78R8534A	—	168

[Note] 1) For further information, consult with JTEKT.

[Remark] Limiting speed of grease lubrication should be kept to under 60 % of that for oil lubrication.

Needle roller and cage assemblies

Double-row
 F_w 20 ~ 39 mm

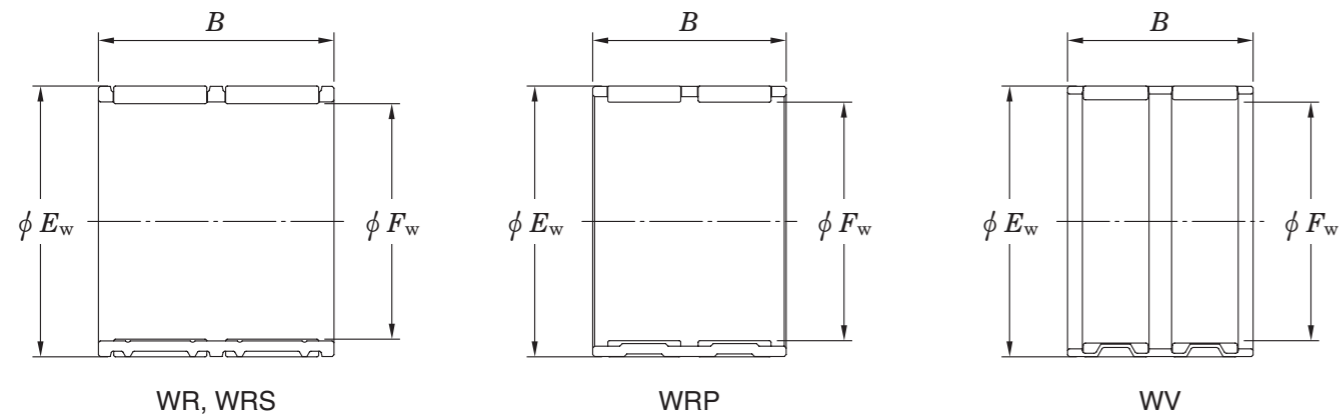

F_w 45 ~ 75 mm

ϕE_w : Roller set outside diameter
 ϕF_w : Roller set bore diameter

Boundary dimensions (mm)			Basic load ratings (kN)		Limiting speeds (min ⁻¹)	Bearing No.	Specification (Cage)	(Refer.) Mass (g)
F_w	E_w	B	C_r	C_{0r}	Oil lub.			
20	25	26	15.7	22.0	22 000	20WR2526	—	27
	25	40	26.8	43.9	22 000	20WR2540	—	39
22	26	26	17.5	30.3	21 000	WRS222626	—	22
24	28	34	21.7	40.9	19 000	WR24/34	—	31
	29	45.5	34.7	64.6	19 000	WRS242946A	—	52
25	29	22	16.0	28.2	19 000	WR25/22	—	22
	29	23.8	17.9	32.5	19 000	WRS252924A	—	23
	29	26	19.4	36.0	19 000	WR25/26	—	25
	30	26	21.9	36.2	18 000	25WR3026	—	32
26	31	24	20.6	33.9	18 000	26WR3124-2	—	30
27	31	23.8	18.7	35.4	17 000	WRS273124A	—	25
	32	23.8	21.0	35.1	17 000	WRS273224A	—	31
30	34	29	14.4	25.5	16 000	30WR3429A	—	32
	37	32	32.4	50.4	15 000	WRS30/32B	—	66
32	37	28	24.4	44.8	14 000	WR32/28	—	43
	37	35	33.2	66.5	14 000	WRS323735	—	53
37	42	35	35.1	75.2	13 000	WRSU374235	Double split	59
38	44	40	43.7	88.1	12 000	WRPU384440F	Double split	75
	44	51	48.9	102	12 000	38WR4451	—	110
39	44	43	40.7	93.0	12 000	WRS394443	Welded	75
	44	43.8	39.0	88.0	12 000	39WR4444	—	80
	46	44.3	54.7	107	12 000	WRP394644A	Welded	97
	46	44.5	54.2	106	12 000	WRS394645A	—	109

[Remark] Limiting speed of grease lubrication should be kept to under 60 % of that for oil lubrication.

Boundary dimensions (mm)			Basic load ratings (kN)		Limiting speeds (min ⁻¹)	Bearing No.	Specification (Cage)	(Refer.) Mass (g)
F_w	E_w	B	C_r	C_{0r}	Oil lub.			
45	50	40.6	42.0	101	11 000	WRSU455041A	Double split	84
	51	40	47.4	104	10 000	WRP455140	Welded	97
47	52	33	37.8	89.9	10 000	WRS475233A-1	Welded	69
	54	38.6	48.5	96.9	9 900	WRP475439A	Welded	107
50	55	45	53.5	144	9 500	WR50/45	—	102
	56	40	51.0	119	9 400	50WR5640	—	110
	58	54	72.8	151	9 300	WRSU505854	Double split	200
51	56	50.8	55.5	151	9 300	51WR5651A	—	118
58	65	42.6	59.2	135	8 100	WRP586543A	Welded	144
60	66	36	50.4	124	7 900	WRP606636	Welded	120
68	73	31.6	44.9	127	7 100	WRS687332A	Welded	90
70	80	55	103	225	6 700	70WR8055	—	351
71	79	46	80.1	194	6 700	WRS717946Z	—	243
75	81	45	71.5	210	6 400	WR75/45	—	183

Needle roller and cage assemblies for use with connecting rods

The Koyo needle roller and cage assembly for use with connecting rod ensures excellent rigidity and a large load rating.

This assembly is also outstanding in wear resistance, light-weight, and is designed to assure a long life. It is widely employed for mini-vehicles, 2-wheel vehicles, snow-mobiles, engines for general use, out board motor, spray units for farming, and high-speed compressors.

The Koyo needle roller and cage assembly for use with connecting rods is available in two types : for a crank pin side (BE, VE and VS...P) and piston pin side (RE, R...P and UR...P).

■ Needle roller and cage assemblies for large ends (BE, VE and VS...P)

The cage is guided by connecting rod bore and is made of special steel. A double split type cage is also manufactured according to the structure of the crank shaft.

■ Needle roller and cage assemblies for small ends (RE, R...P and UR...P)

The cage is guided by the piston pin and incorporates maximum length rollers.

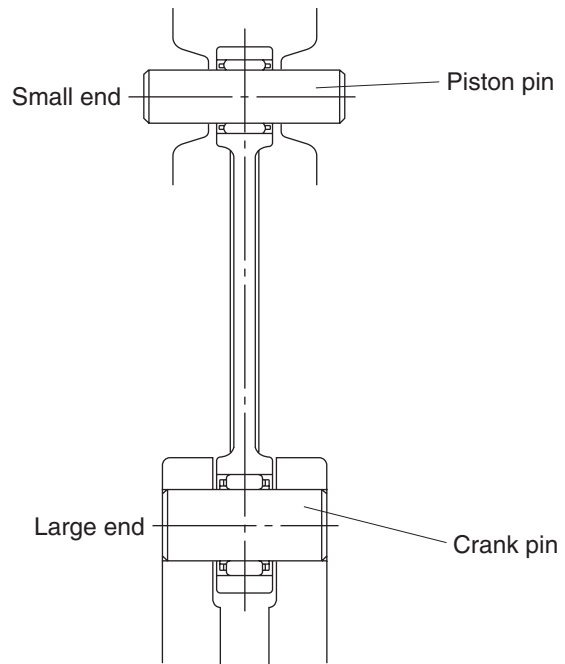

1 Bearing number

(Ex. 1)

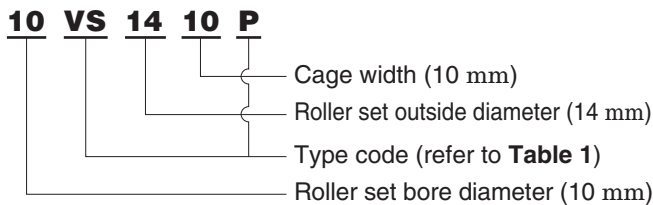

(Ex. 3)

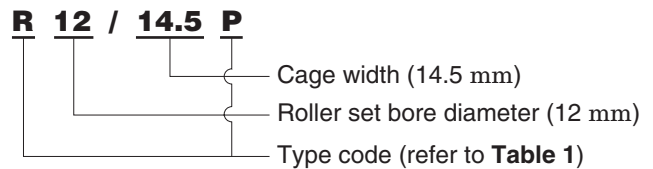

(Ex. 2)

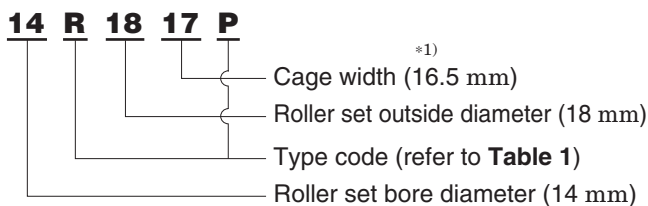

*1) The figure in the bearing number indicating cage width show the value rounded at a decimal of the actual cage width.

Table 1 Type code of needle roller and cage assemblies for use with connecting rods

Type	For use at large end		For use at small end
Type code	BE	VE VS...P	RE R...P UR...P

2 Rods and pins

To get maximum performance out of Koyo needle roller and cage assemblies for use with connecting rods, connecting rod bores serving as the raceway surface of the

bearing, as well as the crank pin and piston pin should always be within the limits given in **Table 2**.

Table 2 Specifications of rods and pins

Item		Connecting Rod Bores	Crank and Piston Pin's Outside Diameters	
Roughness (Ra)		0.2 α or less	0.1 α or less	
Hardness		60 to 64 HRC		
Case Depth (mm) (Up to 550 HV)		0.6 to 1.2 (Set according to the pin diameter and load condition)		
Roundness (μm)	Diameter (mm)	Over 9 up to 18	3 or less	2 or less
		Over 18 up to 30	4 or less	3 or less
		Over 30 up to 40	5 or less	4 or less
Cylindricity (μm)	Diameter (mm)	Over 9 up to 18	2 or less	1 or less
		Over 18 up to 30	3 or less	2 or less
		Over 30 up to 40	4 or less	3 or less
Parallelism ¹⁾		Medium-Low Speed	0.04 mm or less per 100 mm	
		High speed	0.02 mm or less per 100 mm	

[Note] 1) Parallelism between large and small ends

3 Radial clearance

For the selection of clearance for the Koyo needle roller and cage assemblies for use with connecting rods, the engine type and operating conditions must be taken into

account. The recommended clearances are shown in **Table 3**.

The recommended clearance can be obtained by selecting the proper connecting rod bore, pin and needle roller.

Table 3 Recommended radial clearances

Unit : μm

Diameter (mm)		Large End		Small End	
over	up to	min.	max.	min.	max.
—	10	9	25	3	14
10	18	9	25	3	14
18	30	10	25	5	17
30	40	18	33	—	—

Needle roller and cage assemblies

For large ends
 F_w 10 ~ (25) mm

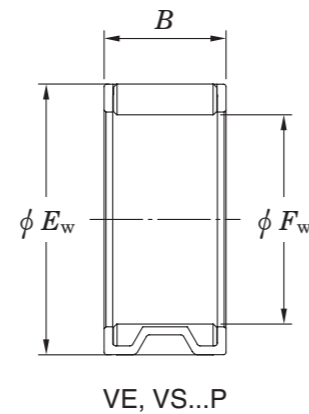
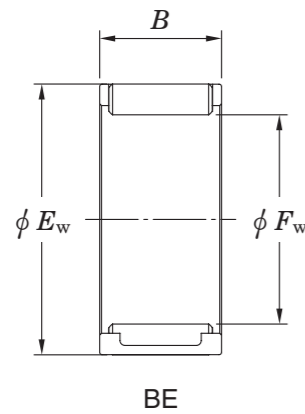

F_w (25) ~ 33 mm

ϕE_w : Roller set outside diameter

ϕF_w : Roller set bore diameter

Boundary dimensions (mm)			Basic load ratings (kN)		Bearing No.	Specification (Cage)	(Refer.) Mass (g)
F_w	E_w	B	C_r	C_{0r}			
10	14	9.8	5.02	4.84	VE101410AB1	—	3.6
12	17	10	6.85	6.61	VE121710B1	Silver plating	5.6
13	18	9.8	6.85	6.70	VE131810AB1	—	5.9
14	19	9.8	6.81	6.78	VE141910AB1	Copper plating	6.2
	19	11.8	7.91	8.21	VE141912AB1	—	7.5
15	21	10	7.75	7.26	15VS2110P-1	—	8.6
16	22	13.2	10.6	11.0	VE162213ASB1	Silver plating	12
17	23	14	11.3	12.1	17VS2314AP	—	13
	24	14	12.9	13.2	17VS2414AP	—	16
18	27	26.8	29.0	32.6	VE182727AB1	Copper plating	42
20	26	14	13.3	15.7	20VS2614CP-1	—	15
	26	16	13.7	16.3	20VS2616P	—	17
	27	13.8	13.7	14.8	VE202714AB1	Silver plating	17
	28	15.8	18.3	19.7	VE202816AB1	Copper plating	25
22	28	13.7	14.8	18.6	BE222814ASB1	Silver plating	17
	28	14	13.2	15.9	22VS2814FP	—	16
	28	15.7	17.8	23.7	BE222816ASB1	Silver plating	20
	29	14	15.3	17.5	22VS2914AP	—	19
	29	15.8	18.9	23.1	BE222916ASB1	Silver plating	25
	29	17	16.8	19.7	22VS2917BP	—	22
24	30	19.7	20.0	28.2	VE243020AB1	Silver plating	24
	31	16.8	21.0	27.1	BE243117ASY1B1	Silver plating, Both sides roller separatable	27
	31	17	18.5	23.0	24VS3117BP-2	—	25
25	31	19.8	19.0	26.5	VE253120AB1-1	Silver plating	24

Boundary dimensions (mm)			Basic load ratings (kN)		Bearing No.	Specification (Cage)	(Refer.) Mass (g)
F_w	E_w	B	C_r	C_{0r}			
25	32	15.8	20.5	26.6	BE253216ASY1B2	Silver plating, Both sides roller separatable	26
	32	16.5	20.5	26.6	BE253217ASY1B2	Silver plating, Both sides roller separatable	28
	32	19.7	24.0	32.6	VE253220AB1	Copper plating	32
	34	17.7	25.8	30.1	25VS3418P	—	37
26	31	13.8	13.5	19.7	VE263114AB1	Copper plating	15
	31	15.8	15.6	23.7	VE263116ASB1-1	Silver plating	17
	32	13.9	15.8	21.3	VE263214BB1	Silver plating	19
	32	19.8	22.5	33.7	BE263220ASB1	Silver plating	30
	33	21.8	24.6	33.8	BE263322ASYB1	Silver plating, One side roller separatable	38
	35	20	28.7	35.0	26VS3520AP-1	—	45
27	34	17.8	20.6	20.8	BE273418ASB1	Silver plating	32
	34	18.8	27.5	39.8	BE273419ASYB1-1	Silver plating, One side roller separatable	36
28	33	13.8	14.3	21.8	VE283314AB1	Silver plating	17
	35	13.8	17.2	21.9	VE283514AB1	Copper plating	24
	36	13.8	19.6	23.7	VE283614AB1	Copper plating	28
	36	15.8	22.1	27.6	VE283616AB1	Copper plating	32
	38	15.8	26.2	29.7	BE283816ASYB1	Copper plating, One side roller separatable	50
	38	16.8	27.2	31.1	28VS3817AP	—	41
30	37	16	20.6	28.3	30VS3716AP-1	—	30
	38	15.8	22.9	29.6	30VS3816P-1	—	34
	39	19.8	32.4	42.7	BE303920ASB1	Silver plating	54
	39	21.8	31.4	40.8	VE303922AB1-1	Silver plating	50
	40	19.8	31.2	37.9	BE304020ASYB2	Silver plating, One side roller separatable	60
32	41	17.8	24.2	29.7	VE324118AB2	Silver plating	46
	41	21.7	34.0	46.1	VE324122ASB1	Silver plating	52
33	41	19.8	30.9	44.6	VE334120AB3	Silver plating	46
	43	21	35.1	45.3	33VS4321P	—	65

Needle roller and cage assemblies

For large ends

F_w 34 ~ 41 mm

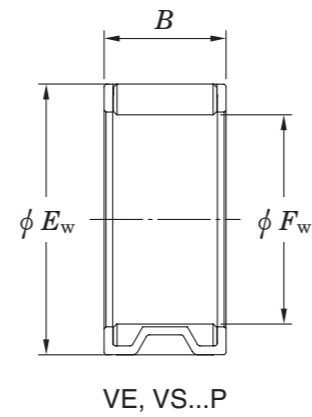
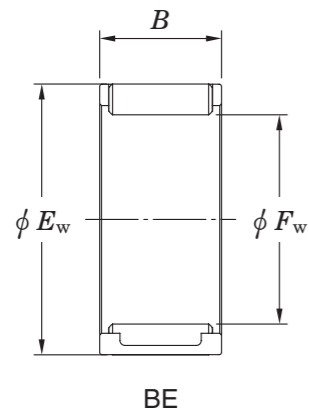

ϕE_w : Roller set outside diameter

ϕF_w : Roller set bore diameter

Boundary dimensions (mm)			Basic load ratings (kN)		Bearing No.	Specification (Cage)	(Refer.) Mass (g)
F_w	E_w	B	C_r	C_{0r}			
34	42	19.8	32.5	48.3	BE344220ASB1	Silver plating	52
	44	19.8	38.5	51.2	BE344420ASY1B1	Silver plating, Both sides roller separatable	64
35	42	19.8	27.0	41.7	VE354220AB1	Silver plating	43
	43	20	31.5	46.8	35VS4320BP	—	51
38	48	22.8	48.7	72.3	BE384823BSY1B1	Silver plating, Both sides roller separatable	87
	50	22.8	51.3	68.2	BE385023ASY1B1-5	Silver plating, Both sides roller separatable	113
41	51	24.8	49.3	75.1	BE415125ASY1B1	Copper plating, Both sides roller separatable	104

Needle roller and cage assemblies

For small ends

F_w 9 ~ (18) mm

F_w (18) ~ 24 mm

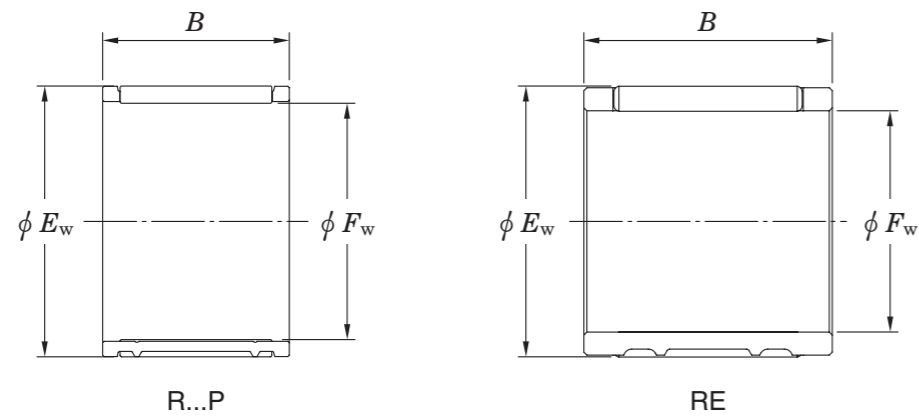

ϕE_w : Roller set outside diameter

ϕF_w : Roller set bore diameter

Boundary dimensions (mm)			Basic load ratings (kN)		Bearing No.	(Refer.) Mass (g)
F_w	E_w	B	C_r	C_{0r}		
9	12	12	4.95	5.57	9R1212P	3.6
10	14	12.5	6.38	6.60	RE101413BL1-1	5.8
12	15	16.3	6.51	8.57	RE121516BL2	5.7
	16	11.8	6.61	7.24	RE121612AL1	6.4
	16	12.8	6.61	7.24	RE121613AL1	7.0
	16	14.8	8.35	9.78	12R1615CP	7.9
	16	15.4	8.35	9.78	RE121615AL1	8.3
	17	14.2	9.08	9.47	RE121714BL2	9.5
14	18	15.8	8.88	11.1	RE141816AL1	9.7
	18	16.5	9.40	11.9	RE141817AL2-2	9.8
	18	17.5	8.27	10.1	14R1818AP-1	11
	18	18.5	8.90	11.1	14R1819AP	11
	18	20	9.43	11.9	14R1820CP	12
	18	21.8	11.5	15.3	14R1822P	13
	19	18	9.96	11.0	14R1918P-2	14
15	19	17	10.5	14.0	15R1917BP-2	11
	19	17.3	9.85	12.9	RE151917BL3	11
	20	17.8	12.3	14.7	RE152018BL2	14
	20	19.8	12.2	14.5	RE152020AL2	17
16	20	18.8	11.0	15.1	R16/18.8AP-2	13
	20	19.5	9.79	13.0	R16/19.5FP	14
	20	22.5	9.77	13.0	R16/22.5EP	16
	21	17.5	12.2	14.8	16R2118BP-2	16
	21	19.5	12.0	14.6	16R2120AP	18
18	22	19.65	10.7	15.2	RE182220AL1	15
	22	22	12.0	17.6	18R2222P	17
	22	23.6	13.1	19.7	RE182224AL2	17

Boundary dimensions (mm)			Basic load ratings (kN)		Bearing No.	(Refer.) Mass (g)
F_w	E_w	B	C_r	C_{0r}		
18	23	22	14.1	18.6	18R2322P	21
19	24	24.8	18.0	26.0	RE192425AL1	26
20	24	13	9.80	14.0	R20/13P-2	10
	25	13	11.1	14.1	20R2513P	13
	25	21.8	17.3	25.0	RE202522AL2	24
	25	23	18.8	27.8	RE202523L2	24
	25	25	18.8	27.8	20R2525P-1	27
	25	27.8	21.4	32.9	RE202528AL1	30
	26	24	19.3	25.4	RE202624L1	33
22	27	24.8	19.4	29.9	RE222725AL1	29
24	29	23.8	21.1	34.1	RE242924AL1	30



Drawn cup needle roller bearings



NEEDLE
ROLLER
BEARINGS

Drawn cup needle roller bearings

Koyo drawn cup needle roller bearings are available in two types : full complement type and caged type. The outer rings of the bearings are made of a high-quality steel strips, press-finished and case-hardened. The rollers are made of a high carbon chromium bearing steel, heat-treated and finished by grinding.

■ Simple structure of housing

The drawn cup needle roller bearings are mounted with interference fit into housings and do not require, housing shoulders, snap rings or other devices for axial location.

■ Easy to mount

The bearings can be easily mounted by press-fitting into the housings.

1 Bearing number

(Ex. 1) Metric series

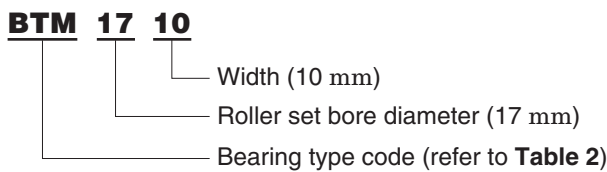

(Ex. 3) Inch series

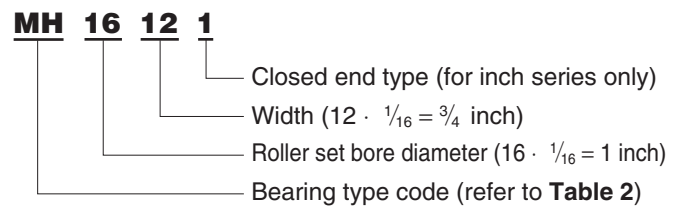

(Ex. 2) Metric series

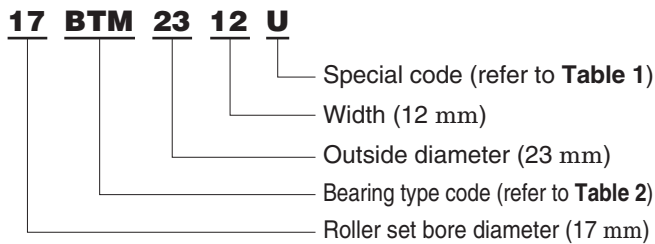

Table 1 Special code

Code	Description
U	Single side sealed
OH	With lubrication hole
J	Bearings designed according to ISO standards

(With lubrication hole)

Table 2 Type code of drawn cup needle roller bearings

Type	Caged type				Full complement type			For universal joint
	Open ends type		Closed end type	Open ends type		Closed end type		
Metric series	BFNM	BTM BHTM	BKM	MKM MHKM	BM BHM	YM	MM	YM (Please consult with JTEKT for details.)
Inch series	—	BT BHT	—	MK MHK	B BH	Y	M MH	

2 Comparison between full complement type and caged type

It is very important to select the most suitable bearings, taking into consideration various conditions such as rotational speeds, load, setting accuracy and lubrication.

Table 3

Rotational Speed	The full complement type bearing is suited for low-speed rotation or oscillating motion, while the caged type is better for high speed application.
Load	When the bearings are the same size, the full complement type bearing has a greater load rating than the caged type. The effective bearing service life, however, should not be judged on load rating only.
Setting accuracy	The caged type bearing is advantageous when tolerance of mounting dimension and shaft deflection are relatively large.
Lubrication	The caged type bearing maintains a larger amount of lubricant than the full complement type. When frequent lubrication is needed, it is convenient to use bearings with lubrication holes.

3 Shaft and housing

The drawn cup needle roller bearings are usually mounted on shafts without inner rings. Therefore, the shafts should satisfy the specifications of **Table 4**.

In addition, the outer rings are made of thin sheet steel, so correct shapes and tolerance can be obtained by fitting the bearings into housings that satisfy the specifications in **Table 4**.

If any shaft cannot be machined with proper finishing accuracy and hardness, use the inner rings. (refer to page 139)

Table 4 Specifications of shafts and housings

	Shaft (Raceway surface)	Housing bore (Fitting surface)
Roundness	Best if less than one half or one third of the shaft diameter (housing bore diameter) tolerance.	
Cylindricity	5 μm or less per 25 mm, or one half or less of the shaft diameter (housing bore diameter) tolerance.	
Roughness (Ra)	0.4 a or less	1.6 a or less
Hardness¹⁾	58 HRC or harder (60 to 64 HRC are best.)	
Others	<ul style="list-style-type: none"> Shaft deflection due to external forces and shaft slope due to tolerance of mounting dimension should be 13 μm or less per 25 mm. 	<ul style="list-style-type: none"> The bore should be a through-hole. To protect the bearing edge, the bearing should be set at least 0.25 mm inside the housing surface. To maintain the tolerance of the bearing, the housing should have sufficient strength so that deformation due to a load is minimized. Split type housing should not be used. If it must be used, the bearing should be fitted into a steel sleeve beforehand.

[Note] 1) Case hardened steel which is carburized or induction-hardened should not only meet the surface hardness requirement specified above but also have a case depth of 52.3 HRC (550 HV) to a depth in the range (0.08 to 0.1) $\times D_w$ mm. (D_w : roller diameter)
In general, 30 thru 45 HRC is best for the center hardness.

4 Fits

Drawn cup needle roller bearings can perform accurately only when press fitted on housings of correct sizes.

When the material for housings is steel or cast iron having

rigidity, the recommended fits are as shown in **Table 5**.

The fits may be partially changed according to the operating conditions (refer to **Table 6**).

Table 5 Recommended fit

Distinction ¹⁾		Inner ring rotation		Outer ring rotation	
		Shaft	Housing bore	Shaft	Housing bore
Metric series		h6	N7	f6	R7
Inch series	$7.144 < D \leq 8.731$ (9/32") (11/32")		0 -0.013 mm		P7
	$8.731 < D$ (11/32")		J7		M7

[Note] 1) D = Nominal outside diameter (mm)

Table 6 Fits altered according to the operating conditions

Distinction ¹⁾		Housing Made of Light Alloy of Steel ²⁾ or Cast Iron of 6 mm or less in thickness	Oscillating Shaft	With ³⁾ Inner Ring
		Housing Bore	Shaft	Shaft
Metric series		R7 or S7	It should be 0.013 mm larger than the recommended tolerance.	j6 is recommended
Inch series	$7.144 < D \leq 8.731$ (9/32") (11/32")	P7 or R7		
	$8.731 < D$ (11/32")	M7 or R7		

[Notes] 1) D = Nominal outside diameter (mm)

2) This tolerance varies depending on the material and the shape of the housing. The optimum value must be determined by actual mounting. For details, consult with JTEKT.

3) When specially interference fitted, consult with JTEKT.

5 Internal clearance and outer ring width tolerances

The radial internal clearance with a drawn cup needle roller bearing mounted on a housing varies depending on the tolerances for the bearing, housing and shaft. For example, the relationship between the radial internal clearance and the dimensional tolerances in the case of Koyo drawn cup needle roller bearing "B1212" is shown in **Table 7**.

Generally, radial internal clearance is reduced not by decreasing the housing bore size, but by increasing the shaft diameter.

Table 7 Radial internal clearance for bearing "B1212" (Calculation example)

Unit : mm

Conditions		Dimensional tolerances (1) Housing bore (refer to specification table on page 103) $\begin{cases} H_{max.} = 25.412 \\ H_{min.} = 25.391 \end{cases}$ (25.4 J7) (2) Roller set (When press fitted into a ring gauge of bore diameter $\phi H = 25.387 \dots$ refer to Table 10 on page 74) $\begin{cases} F_{w max.} = 19.088 \\ F_{w min.} = 19.063 \end{cases}$ (3) Shaft diameter (refer to specification table on page 103) $\begin{cases} S_{max.} = 19.050 \\ S_{min.} = 19.037 \end{cases}$ (19.050 h6)
	(4) Roller set bore diameter when press fitted into this housing. From (1) and (2), $\begin{cases} A_{max.} = (H_{max.} - H) + F_{w max.} = 19.113 \\ A_{min.} = (H_{min.} - H) + F_{w min.} = 19.067 \end{cases}$	
Radial internal clearance (after mounting)	$\begin{cases} R_{s max.} = A_{max.} - S_{min.} = 0.076 \\ R_{s min.} = A_{min.} - S_{max.} = 0.017 \end{cases}$	

Table 8 Tolerances of outer ring width

Unit : mm

Outer ring width <i>C</i>	Deviation of a single outer ring width ΔC_s	
	upper	lower
All widths	0	-0.3

6 Mounting

Since the drawn cup needle roller bearing must be press fitted into a housing, and an installation jig must be used.

The jig used to mount open type bearings is shown in **Fig. 1**.

An ordinary hand press is safe and convenient to use for the press fitting of bearings.

Instruction for mounting bearings

- When mounting bearings of the below-mentioned types, the marking side should be touching the shoulder of the pressing jig.
 (BM, BHM, MM, MKM, MHKM)
 (B, BH, M, MH, MK, MHK)
- The bearing should not be pounded into its housing with a hammer or other impact tool, even in conjunction with the mounting jig.
- The shoulder of the mounting jig should be given a slope of 15° so that it will not damage the edge of the bearing.
- The mounting jig should have flange as stopper and guide for correct mounting, as shown in **Fig. 1**. (The ball and spring in the jig are intended to prevent the roller from falling during the press fitting of the bearing, and to make the job easier.)

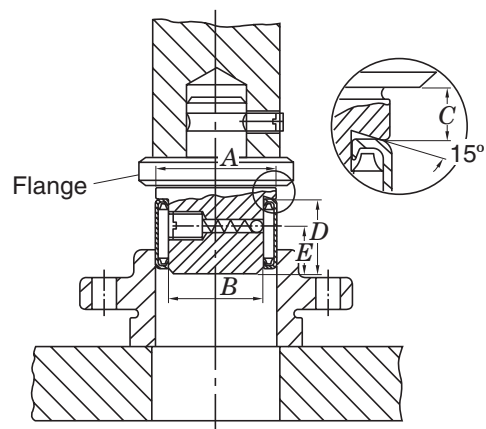

- A = Housing bore diameter - 0.05 mm
- B = Shaft diameter - 0.10 mm
- C = 0.20 mm (min.)
- D = Bearing width ± 1.0 mm
- E = Approx. 1/2 D

Fig. 1

7 Inspection

The outer rings of Koyo drawn cup needle roller bearings are manufactured by drawing the steel sheet into the correct shape; however, they may go out of round in the heat treatment.

When the bearings are pressed into true round housing of accurate sizes and wall thickness, they become round and proper size for satisfactory bearing performance. For this reason, it is meaningless to inspect unmounted drawn cup bearings by measuring O.D.

The bearings are designed to possess optimum internal clearances, and it is usually unnecessary to inspect them.

If the inspection is necessary, it is best to follow the procedure given below. (specified in JIS B 1515-2)

- 1) Press the bearing into a ring gauge of the correct size.
- 2) Check the bearing bore diameter (roller set bore diameter) by plugging with the "Go end" and "No-Go end" gauges.

The sizes of the gauges (ring gauge and plug gauge) are shown in **Tables 9** and **10**.

Table 11 shows the bearing ring gauge specifications and the tolerances of roller set bore diameter specified in JIS B 1536-2 (conform to ISO standards).

Table 9 Inspecting gauge specifications (metric series)

Unit : mm

Nominal roller set bore diameter F_w	Ring gauge	Plug gauge	
		Go end	No-Go end
4	7.996	4.023	4.048
5	8.996	5.023	5.048
6	9.996	6.028	6.053
7	10.995	7.031	7.056
8	11.995	8.031	8.056
	14.995		
9	12.995	9.031	9.056
	15.995		
10	13.995	10.031	10.056
	16.995		
12	15.995	12.031	12.056
	17.995		
	18.993		
13	18.993	13.034	13.059
14	18.993	14.034	14.059
	19.993		
15	21.993	15.034	15.059
	20.993		
16	21.993	16.034	16.059
	23.993		
17	21.972	17.013	17.038
	22.972		
	23.972		
18	23.972	18.013	18.038
	24.972		
19	26.972	19.013	19.038
20	25.972	20.013	20.038
	26.972		
22	27.972	22.013	22.038
	28.972		
	29.972		

Nominal roller set bore diameter F_w	Ring gauge	Plug gauge	
		Go end	No-Go end
24	29.972	24.013	24.038
	30.967		
	34.967		
25	31.967	25.013	25.038
	32.967		
26	33.967	26.013	26.038
28	33.967	28.013	28.038
	34.967		
	36.967		
30	36.967	30.013	30.038
	37.967		
	39.967		
32	37.967	32.013	32.038
	39.967		
	41.967		
35	41.967	35.013	35.038
	44.967		
36	41.967	36.013	36.038
	43.967		
37	47.967	37.013	37.038
	42.967		
	46.967		
38	47.967	38.013	38.038
40	46.967	40.013	40.043
	49.967		
45	51.961	45.013	45.043
	54.961		
50	57.961	50.013	50.043
	61.961		
55	62.961	55.013	55.051

Table 10 Inspecting gauge specifications (inch series)

Unit : mm

Nominal roller set bore diameter F_w	Ring gauge	Plug gauge	
		Go end	No-Go end
4.762 (3/16)	8.730	4.783	4.808
6.350 (1/4)	11.125	6.388	6.413
7.938 (5/16)	12.713	7.976	8.001
	14.300		
9.525 (3/8)	14.300	9.563	9.588
	15.888		
11.112 (7/16)	15.888	11.151	11.176
	17.475		
12.700 (1/2)	17.475	12.738	12.763
	19.063		
14.288 (9/16)	19.063	14.326	14.351
	20.650		
15.875 (5/8)	20.650	15.913	15.938
	22.237		
17.462 (11/16)	22.237	17.501	17.526
	23.825		
19.050 (3/4)	25.387	19.063	19.088
	26.975		
20.638 (13/16)	28.562	20.650	20.675
	28.562		
22.225 (7/8)	30.150	22.238	22.263
	30.150		
23.812 (15/16)	31.737	23.825	23.850
	33.325		
25.400 (1)	31.737	25.413	25.438
	33.325		

Nominal roller set bore diameter F_w	Ring gauge	Plug gauge	
		Go end	No-Go end
26.988 (1 1/16)	33.325	27.000	27.025
28.575 (1 1/8)	34.912	28.588	28.613
	38.087		
30.162 (1 3/16)	38.087	30.175	30.200
31.750 (1 1/4)	38.087	31.763	31.788
	41.262		
33.338 (1 5/16)	41.262	33.350	33.378
34.925 (1 3/8)	41.262	34.938	34.966
	44.437		
38.100 (1 1/2)	47.612	38.113	38.143
41.275 (1 5/8)	50.787	41.288	41.318
44.450 (1 3/4)	53.962	44.463	44.496
47.625 (1 7/8)	57.137	47.638	47.671
50.800 (2)	60.312	50.815	50.848
52.388 (2 1/16)	64.280	52.413	52.451
53.975 (2 1/8)	63.487	53.990	54.028
57.150 (2 1/4)	66.662	57.165	57.203
63.500 (2 1/2)	73.139	63.515	63.553
66.675 (2 5/8)	76.187	66.700	66.738
69.850 (2 3/4)	79.362	69.875	69.913
88.900 (3 1/2)	101.587	88.925	88.963

**Table 11 Ring gauge specifications and roller set bore diameter tolerance
(for bearings designed according to ISO standards)**

Unit : mm

Nominal roller set bore diameter F_w	Nominal outside diameter D	Ring gauge	Roller set bore diameter F_w tolerance	
			lower	upper
4	8	7.984	4.010	4.028
5	9	8.984	5.010	5.028
6	10	9.984	6.010	6.028
7	11	10.980	7.013	7.031
8	12	11.980	8.013	8.031
	14	13.980		
9	13	12.980	9.013	9.031
	15	14.980		
10	14	13.980	10.013	10.031
	16	15.980		
12	16	15.980	12.016	12.034
	18	17.980		
14	20	19.976	14.016	14.034
	22	21.976		
15	21	20.976	15.016	15.034
	23	22.976		
16	22	21.976	16.016	16.034
	24	23.976		
17	23	22.976	17.016	17.034
	25	24.976		
18	24	23.976	18.016	18.034
	26	25.976		
20	26	25.976	20.020	20.041
	28	27.976		
22	28	27.976	22.020	22.041
	30	29.976		

Nominal roller set bore diameter F_w	Nominal outside diameter D	Ring gauge	Roller set bore diameter F_w tolerance	
			lower	upper
25	32	31.972	25.020	25.041
	35	34.972		
28	35	34.972	28.020	28.041
	38	37.972		
30	37	36.972	30.020	30.041
	40	39.972		
32	39	38.972	32.025	32.050
	42	41.972		
35	42	41.972	35.025	35.050
	45	44.972		
38	45	44.972	38.025	38.050
	48	47.972		
40	47	46.972	40.025	47.050
	50	49.972		
42	49	48.972	42.025	42.050
	52	51.967		
45	52	51.967	45.025	45.050
	55	54.967		
50	58	57.967	32.025	32.050
55	63	62.967	55.030	55.060
60	68	67.967	60.030	60.060
65	73	72.967	65.030	65.060
70	78	77.967	70.030	70.060

[Remark] The supplementary code "J" is added as a suffix to the bearing numbers that are designed according to ISO standards.

Drawn cup needle roller bearings

Metric series

F_w 4 ~ (12) mm

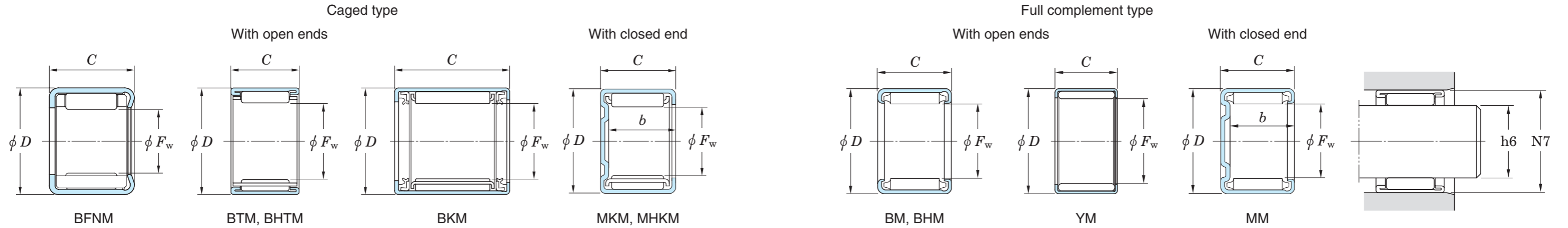

Boundary dimensions (mm)				Basic load ratings (kN)		Limiting speeds (min ⁻¹)	Bearing No. ²⁾				Recommended dimensions (mm)				(Refer.) Mass (g)	
F_w	D	C	$b_{min.}$	C_r	C_{0r}	Oil lub.	Caged type		Full complement type		Shaft dia. (h6)		Housing bore dia. (N7)		With open ends	With closed end
							With open ends	With closed end	With open ends	With closed end	min.	max.	min.	max.		
4	8	8	—	1.60	1.25	47 000	4BFNM88	—	—	—	3.992	4.000	7.981	7.996	1.3	—
5	9	9	—	2.40	2.15	44 000	5BFNM99	—	—	—	4.992	5.000	8.981	8.996	1.8	—
6	10	9	6	2.40	2.40	42 000	6BTM109	—	—	—	5.992	6.000	9.981	9.996	2.5	—
7	11	9	—	2.55	2.70	39 000	7BTM119	—	—	—	6.991	7.000	10.977	10.995	2.9	—
8	12	10	8.4	3.25	3.85	37 000	8BTM1210	8MKM1210	—	—	7.991	8.000	11.977	11.995	3.6	4.1
	12	10	7.8	4.95	7.50	13 000	—	—	BM081210	8MM1210	7.991	8.000	11.977	11.995	3.7	4.2
	12	10	—	5.25	8.60	13 000	—	—	YM081210	—	7.991	8.000	11.977	11.995	4.0	—
	15	10	8.4	4.00	3.30	34 000	BHTM810	MHKM810	—	—	7.991	8.000	14.977	14.995	6.5	7.3
	15	15	—	7.45	6.50	34 000	BHTM815	—	—	—	7.991	8.000	14.977	14.995	9.4	—
	15	20	17.3	9.25	9.70	34 000	BHTM820	MHKM820	—	—	7.991	8.000	14.977	14.995	13	14
9	13	10	7.8	4.90	8.05	12 000	—	—	9BM1310	9MM1310	8.991	9.000	12.977	12.995	4.0	4.6
	13	10	8.4	3.35	4.10	35 000	9BTM1310A	9MKM1310	—	—	8.991	9.000	12.977	12.995	3.8	4.3
	13	12	10.4	4.20	5.50	35 000	9BTM1312	9MKM1312	—	—	8.991	9.000	12.977	12.995	4.6	5.2
	16	12	10.4	5.35	5.05	32 000	BHTM912-1	MHKM912	—	—	8.991	9.000	15.977	15.995	8.8	9.9
	16	16	13.3	7.55	7.90	32 000	BHTM916	MHKM916	—	—	8.991	9.000	15.977	15.995	12	13
10	14	10	7.8	5.70	9.35	11 000	—	—	10BM1410	10MM1410	9.991	10.000	13.977	13.995	4.2	4.8
	14	10	8.4	3.55	4.55	33 000	10BTM1410	10MKM1410	—	—	9.991	10.000	13.977	13.995	4.2	4.8
	14	12	10.4	4.40	6.00	33 000	10BTM1412	10MKM1412	—	—	9.991	10.000	13.977	13.995	5.0	5.7
	14	15	11.8	5.65	8.25	33 000	BTM101415	—	—	—	9.991	10.000	13.977	13.995	6.4	—
	17	10	8.4	4.65	4.25	30 000	BHTM1010	MHKM1010	—	—	9.991	10.000	16.977	16.995	7.8	8.9
	17	12	10.4	6.00	5.90	30 000	BHTM1012-1	MHKM1012	—	—	9.991	10.000	16.977	16.995	9.4	11
	17	15	—	7.85	8.45	30 000	BHTM1015	—	—	—	9.991	10.000	16.977	16.995	12	—
	17	20	17.3	10.7	12.5	30 000	BHTM1020	MHKM1020	—	—	9.991	10.000	16.977	16.995	16	18
12	16	10	8.4	4.00	5.60	29 000	12BTM1610	12MKM1610	—	—	11.989	12.000	15.977	15.995	5.0	5.6

[Notes] 1) The limiting speeds shown above are applicable when oil seal is used and the bearing is lubricated with grease.
 2) FN in bearing number indicates a bearing comprising polyamide molded cage.
 3) The recommended dimensional tolerances of shaft shown above are applicable except h6.
 4) The recommended dimensional tolerances of housing bore shown above are applicable except N7.

[Remark] Limiting speed of grease lubrication should be kept to under 60 % of that for oil lubrication.

Drawn cup needle roller bearings

Metric series

F_w (12) ~ 14.50 mm

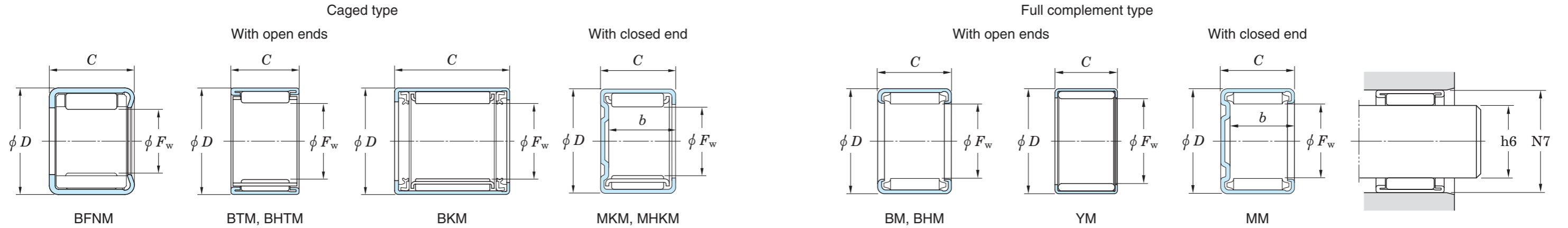

Boundary dimensions (mm)				Basic load ratings (kN)		Limiting speeds (min ⁻¹)	Bearing No. ²⁾				Recommended dimensions (mm)				(Refer.) Mass (g)	
F_w	D	C	$b_{min.}$	C_r	C_{0r}	Oil lub.	Caged type		Full complement type		Shaft dia. (h6)		Housing bore dia. (N7)		With open ends	With closed end
							With open ends	With closed end	With open ends	With closed end	min.	max.	min.	max.		
12	18	10	8.4	4.60	4.80	27 000	12BTM1810	12MKM1810	—	—	11.989	12.000	17.977	17.995	7.2	8.2
	18	12	9.6	8.40	12.6	9 400	—	—	12BM1812	12MM1812	11.989	12.000	17.977	17.995	9.7	11
	18	12	9.3	5.95	6.70	27 000	12BTM1812	12MKM1812	—	—	11.989	12.000	17.977	17.995	7.6	8.5
	18	15	—	6.10	7.32	27 000	12BTM1815A	—	—	—	11.989	12.000	17.991 ⁴⁾	18.012 ⁴⁾	12	—
	18	16	—	5.65	6.25	16 000 ¹⁾	12BKM1816UU	—	—	—	11.989	12.000	17.977	17.995	11	—
	19	12	9.3	6.70	6.95	26 000	BHTM1212-1	MHKM1212	—	—	11.989	12.000	18.972	18.993	10	12
	19	15	—	8.85	9.95	26 000	BHTM1215-1	MKM121915	—	—	11.989	12.000	18.972	18.993	13	—
	19	20	17.3	12.1	14.9	26 000	BHTM1220	MHKM1220	—	—	11.989	12.000	18.972	18.993	17	19
	19	25	—	15.0	19.6	26 000	BHTM1225	—	—	—	11.989	12.000	18.972	18.993	21	—
13	17	15	—	5.10	7.85	27 000	BKM131715J	—	—	—	12.989	12.000	16.977	16.995	7.1	—
	19	12	—	8.55	13.4	9 100	—	—	13BM1912	—	12.989	13.000	18.972	18.993	10	—
	19	12	9.3	5.85	6.70	26 000	13BTM1912	13MKM1912	—	—	12.989	13.000	18.972	18.993	9.5	11
	19	14	—	7.65	9.60	26 000	BKM131914J	—	—	—	12.989	13.000	18.972	18.993	11	—
	20	12	—	7.50	8.40	25 000	13BTM2012J	—	—	—	12.989	13.000	19.972	19.993	11	—
	21	14	—	9.75	10.5	25 000	BKM132114BJ	—	—	—	12.989	13.000	20.972	20.993	15	—
13.50	19	12	—	6.25	7.95	25 000	BTM141912A	—	—	—	13.447 ³⁾	13.460 ³⁾	19.000 ⁴⁾	19.021 ⁴⁾	9.5	—
14	19	16	13.7	11.7	23.3	8 800	—	—	14BM1916	14MM1916	13.989	14.000	18.972	18.993	12	14
	19	16	13.3	7.85	11.7	25 000	14BTM1916B	14MKM1916	—	—	13.983 ³⁾	13.994 ³⁾	18.972	18.993	11	12
	20	12	9.6	9.15	14.6	8 600	—	—	14BM2012	14MM2012	13.989	14.000	19.972	19.993	11	12
	20	12	9.3	6.10	7.20	25 000	14BTM2012	14MKM2012	—	—	13.989	14.000	19.972	19.993	9.8	11
	20	16	13.7	12.7	22.4	8 600	—	—	14BM2016	14MM2016	13.989	14.000	19.972	19.993	15	17
	20	16	13.3	8.75	11.4	25 000	14BTM2016	14MKM2016	—	—	13.989	14.000	19.972	19.993	13	15
	20	25	—	12.2	15.5	14 000 ¹⁾	14BKM2025JUJ	—	—	—	13.989	14.000	19.972	19.993	20	—
	22	16	13.3	11.1	12.6	23 000	BHTM1416	MHKM1416	—	—	13.989	14.000	21.972	21.993	19	21
	22	20	17.3	14.4	17.5	23 000	BHTM1420	MHKM1420	—	—	13.989	14.000	21.972	21.993	23	26
14.50	19.50	13.50	—	7.55	10.9	25 000	BTM152014A	—	—	—	14.489	14.500	19.472	19.493	9.5	—

[Notes] 1) The limiting speeds shown above are applicable when oil seal is used and the bearing is lubricated with grease.

2) FN in bearing number indicates a bearing comprising polyamide molded cage.

3) The recommended dimensional tolerances of shaft shown above are applicable except h6.

4) The recommended dimensional tolerances of housing bore shown above are applicable except N7.

[Remark] Limiting speed of grease lubrication should be kept to under 60 % of that for oil lubrication.

Drawn cup needle roller bearings

Metric series

F_w 15 ~ (17) mm

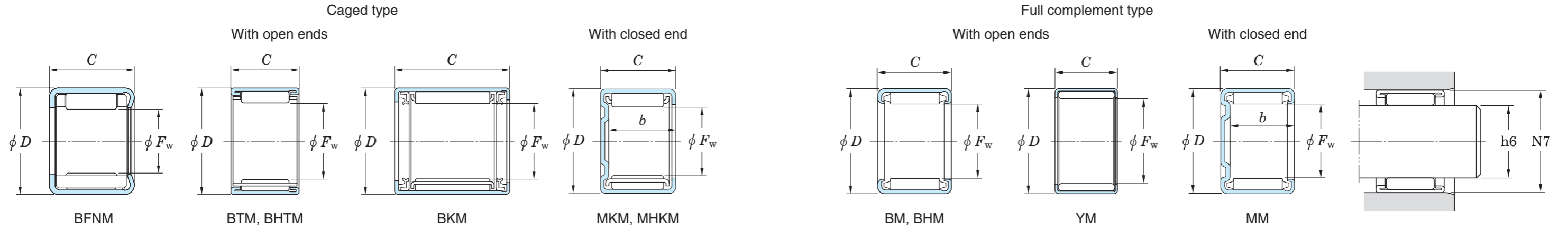

Boundary dimensions (mm)				Basic load ratings (kN)		Limiting speeds (min ⁻¹)	Bearing No. ²⁾				Recommended dimensions (mm)				(Refer.) Mass (g)	
F_w	D	C	$b_{min.}$	C_r	C_{0r}	Oil lub.	Caged type		Full complement type		Shaft dia. (h6)		Housing bore dia. (N7)		With open ends	With closed end
							With open ends	With closed end	With open ends	With closed end	min.	max.	min.	max.		
15	20	16	—	8.15	12.6	24 000	15BTM2016C-2	—	—	—	14.989	15.000	19.991 ⁴⁾	20.012 ⁴⁾	12	—
	21	10	—	7.70	11.8	8 100	—	—	15BM2110	—	14.989	15.000	20.972	20.993	9.4	—
	21	10	—	5.25	6.25	23 000	15BTM2110JA	—	—	—	14.989	15.000	20.991 ⁴⁾	21.012 ⁴⁾	9.5	—
	21	12	9.6	9.70	15.9	8 100	—	—	15BM2112	15MM2112	14.989	15.000	20.972	20.993	12	13
	21	12	9.3	7.00	8.80	23 000	15BTM2112-1	15MKM2112	—	—	14.989	15.000	20.972	20.993	11	12
	21	16	13.7	13.4	24.2	8 100	—	—	15BM2116	15MM2116	14.989	15.000	20.972	20.993	16	18
	21	16	13.3	9.80	13.6	23 000	15BTM2116	15MKM2116	—	—	14.989	15.000	20.972	20.993	14	16
	21	22	—	13.0	19.5	23 000	15BTM2122	—	—	—	14.989	15.000	20.991 ⁴⁾	21.012 ⁴⁾	20	—
	22	10	8.4	6.15	6.45	23 000	BHTM1510	MHKM1510	—	—	14.989	15.000	21.972	21.993	9.9	11
	22	12	9.3	6.90	7.95	23 000	BHTM1512A	MHKM1512	—	—	14.989	15.000	21.991 ⁴⁾	22.012 ⁴⁾	12	14
	22	15	—	10.9	13.3	23 000	BHTM1515-1	—	—	—	14.989	15.000	21.972	21.993	10	—
	22	20	17.3	14.2	18.8	23 000	BHTM1520	MHKM1520	—	—	14.989	15.000	21.972	21.993	20	23
	22	25	—	17.7	25.0	23 000	BHTM1525	—	—	—	14.989	15.000	21.972	21.993	26	—
16	22	12	9.6	10.2	17.1	7 700	—	—	16BM2212	16MM2212	15.989	16.000	21.972	21.993	12	14
	22	12	9.3	7.60	9.80	22 000	16BTM2212A	16MKM2212	—	—	15.989	16.000	21.991 ⁴⁾	22.012 ⁴⁾	11	12
	22	16	13.7	14.1	25.9	7 700	—	—	16BM2216	16MM2216	15.989	16.000	21.972	21.993	17	19
	22	16	13.3	10.7	15.1	22 000	16BTM2216	16MKM2216	—	—	15.989	16.000	21.972	21.993	15	17
	22	22	—	16.2	22.9	22 000	16BTM2222B	—	—	—	15.989	16.000	21.991 ⁴⁾	22.012 ⁴⁾	20	—
	24	12	—	8.00	8.45	21 000	BHTM1612	—	—	—	15.989	16.000	23.972	23.993	15	—
	24	16	13.3	12.2	14.9	21 000	BHTM1616A	MHKM1616	—	—	15.989	16.000	23.991 ⁴⁾	24.012 ⁴⁾	20	23
24.15	14	12.6	8.45	9.05	12 000 ¹⁾	—	MKM162414U	—	—	15.989	16.000	24.122	24.143	—	19	
17	21.50	15	10.6	6.15	9.60	22 000	17BTM2215	—	—	—	16.989	17.000	21.472	21.493	10	—
	22	10	—	5.05	6.90	21 000	BTM1710	—	—	—	16.989	17.000	21.972	21.993	8.2	—
	22	13	—	10.6	21.6	7 500	—	—	BM1713-1	—	16.989	17.000	21.972	21.993	12	—
	23	12	9.6	10.3	17.9	7 300	—	—	17BM2312	17MM2312	16.989	17.000	22.972	22.993	13	15
	23	12	—	7.65	10.2	21 000	BTM172312	—	—	—	16.989	17.000	22.972	22.993	12	—
	23	20	—	18.0	36.7	7 300	—	—	17BM2320	—	16.989	17.000	22.972	22.993	23	—

[Notes] 1) The limiting speeds shown above are applicable when oil seal is used and the bearing is lubricated with grease.

2) FN in bearing number indicates a bearing comprising polyamide molded cage.

3) The recommended dimensional tolerances of shaft shown above are applicable except h6.

4) The recommended dimensional tolerances of housing bore shown above are applicable except N7.

[Remark] Limiting speed of grease lubrication should be kept to under 60 % of that for oil lubrication.

Drawn cup needle roller bearings

Metric series

F_w (17) ~ 19 mm

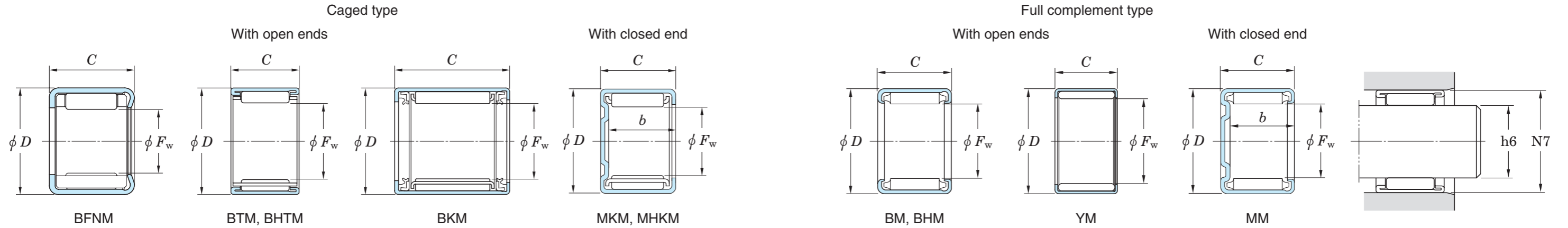

Boundary dimensions (mm)				Basic load ratings (kN)		Limiting speeds (min ⁻¹)	Bearing No. ²⁾				Recommended dimensions (mm)				(Refer.) Mass (g)	
F_w	D	C	$b_{min.}$	C_r	C_{0r}	Oil lub.	Caged type		Full complement type		Shaft dia. (h6)		Housing bore dia. (N7)		With open ends	With closed end
							With open ends	With closed end	With open ends	With closed end	min.	max.	min.	max.		
17	24	12	—	12.8	21.0	7 200	—	—	YM172412-1	—	16.983 ³⁾	16.994 ³⁾	23.985 ⁴⁾	24.006 ⁴⁾	17	—
	24	15	—	11.2	14.8	20 000	BHTM1715-1	—	—	—	16.989	17.000	23.972	23.993	17	—
	24	17	—	16.0	27.9	7 200	—	—	BM172417-1	—	16.989	17.000	23.991 ⁴⁾	24.012 ⁴⁾	23	—
	24	20	—	12.9	17.6	11 000 ¹⁾	BHKM1720JBU	—	—	—	16.989	17.000	23.972	23.993	22	—
	24	20	—	19.0	21.9	7 200	—	—	BHM1720A	—	16.983 ³⁾	16.994 ³⁾	23.985 ⁴⁾	24.006 ⁴⁾	27	—
	24	20	17.3	15.1	21.6	20 000	BHTM1720-1	MHKM1720	—	—	16.989	17.000	23.972	23.993	24	27
	24	25	—	23.8	46.6	7 200	—	—	BHM1725	—	16.989	17.000	23.991 ⁴⁾	24.012 ⁴⁾	35	—
	24	25	—	19.0	29.0	20 000	BTM172425	—	—	—	16.983 ³⁾	16.994 ³⁾	23.972	23.993	22	—
	24	26	—	16.0	23.3	11 000 ¹⁾	BHKM1726JUU	—	—	—	16.999	17.000	23.972	23.993	29	—
	24	30	—	20.1	31.3	11 000 ¹⁾	BHKM1730JU	—	—	—	16.989	17.000	23.972	23.993	35	—
	25	14	—	7.30	7.90	11 000 ¹⁾	BKM172514UH-1	—	—	—	16.989	17.000	24.991 ⁴⁾	25.012 ⁴⁾	18	—
	25	15	—	10.9	13.1	20 000	BKM172515	—	—	—	16.989	17.000	24.991 ⁴⁾	25.012 ⁴⁾	20	—
	25	16.70	—	7.30	7.90	11 000 ¹⁾	17BKM2517JBUUH	—	—	—	16.989	17.000	24.972	24.993	20	—
	25	18	—	10.9	13.1	11 000 ¹⁾	BKM172518UH	—	—	—	16.989	17.000	24.991 ⁴⁾	25.012 ⁴⁾	24	—
	25	20	—	12.9	16.3	11 000 ¹⁾	BKM172520UH-1	—	—	—	16.989	17.000	24.991 ⁴⁾	25.012 ⁴⁾	27	—
18	24	12	9.6	10.8	19.2	6 900	—	—	18BM2412	18MM2412	17.989	18.000	23.972	23.993	17	20
	24	12	—	7.90	10.9	20 000	18BTM2412	—	—	—	17.989	18.000	23.991 ⁴⁾	24.012 ⁴⁾	12	—
	24	16	13.7	16.5	29.1	6 900	—	—	18BM2416	18MM2416	17.989	18.000	23.972	23.993	18	21
	24	16	—	17.2	30.7	6 900	—	—	18YM2416	—	17.989	18.000	23.972	23.993	19	—
	24	16	—	11.1	16.8	20 000	BTM182416	—	—	—	17.989	18.000	23.972	23.993	17	—
	25	13	—	9.40	11.8	19 000	BTM1813	—	—	—	17.989	18.000	24.972	24.993	15	—
	25	15	—	10.4	9.25	19 000	BTM1815	—	—	—	17.989	18.000	24.972	24.993	18	—
	25	17	—	12.2	17.7	19 000	BTM1817A	—	—	—	17.989	18.000	24.991 ⁴⁾	25.012 ⁴⁾	20	—
	25	19	—	14.4	20.5	19 000	BTM1819	—	—	—	17.989	18.000	24.972	24.993	22	—
	25	20	17.3	15.2	22.1	19 000	BTM182520	MKM1820	—	—	17.989	18.000	24.972	24.993	24	27
	25	25	—	18.9	29.2	19 000	BTM1825A	—	—	—	17.989	18.000	24.972	24.993	29	—
	19	27	20	—	17.0	23.4	18 000	BHTM1920	—	—	—	18.987	19.000	26.972	26.993	30

[Notes] 1) The limiting speeds shown above are applicable when oil seal is used and the bearing is lubricated with grease.

2) FN in bearing number indicates a bearing comprising polyamide molded cage.

3) The recommended dimensional tolerances of shaft shown above are applicable except h6.

4) The recommended dimensional tolerances of housing bore shown above are applicable except N7.

[Remark] Limiting speed of grease lubrication should be kept to under 60 % of that for oil lubrication.

Drawn cup needle roller bearings

Metric series

F_w 19.50 ~ (22) mm

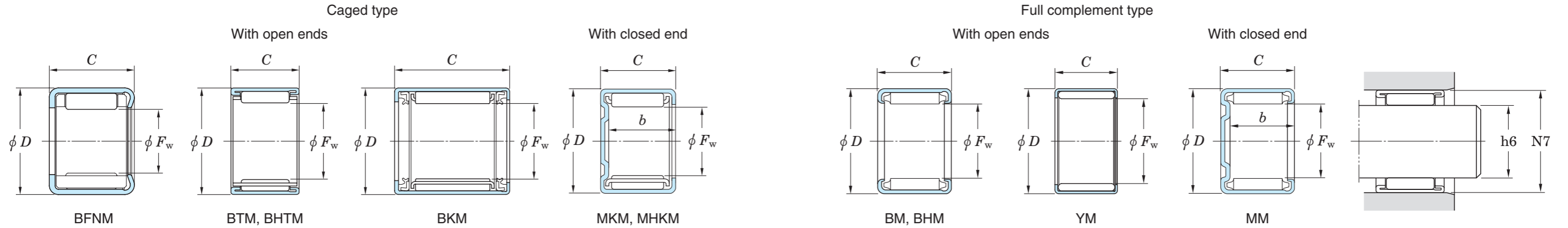

Boundary dimensions (mm)				Basic load ratings (kN)		Limiting speeds (min ⁻¹)	Bearing No. ²⁾				Recommended dimensions (mm)				(Refer.) Mass (g)		
F_w	D	C	$b_{min.}$	C_r	C_{0r}	Oil lub.	Caged type		Full complement type		Shaft dia. (h6)		Housing bore dia. (N7)		With open ends	With closed end	
							With open ends	With closed end	With open ends	With closed end	min.	max.	min.	max.			
19.50	29	20	—	18.8	23.6	17 000	20BTM2920	—	—	—	19.487	19.500	28.972	28.993	36	—	
20	26	12	9.6	10.6	20.4	6 300	—	—	20BM2612	20MM2612	19.987	20.000	25.972	25.993	15	17	
	26	12	9.3	8.50	12.6	18 000	20BTM2612	20MKM2612	—	—	19.987	20.000	25.972	25.993	14	16	
	26	14	—	15.1	31.4	6 300	—	—	YM202614	—	19.987	20.000	25.972	25.993	19	—	
	26	16	13.7	14.8	31.4	6 300	—	—	20BM2616	20MM2616	19.987	20.000	25.972	25.993	21	23	
	26	16	13.3	12.4	20.3	18 000	BTM202616	20MKM2616	—	—	19.987	20.000	25.972	25.993	19	21	
	26	20	17.2	18.8	42.5	6 300	—	—	20BM2620	20MM2620	19.987	20.000	25.972	25.993	26	30	
	26	20	—	15.2	26.4	18 000	20BTM2620A	—	—	—	—	19.987	20.000	25.972	25.993	24	—
	27	13	10.6	13.1	22.2	6 200	—	—	BM2013	MM2013	19.987	20.000	26.972	26.993	18	21	
	27	15	—	15.6	27.7	6 200	—	—	BM2015	—	19.987	20.000	26.972	26.993	22	—	
	27	15	—	13.1	18.7	18 000	BTM2015	—	—	—	—	19.870	20.000	26.972	26.993	20	—
	27	20	17.3	17.7	27.6	18 000	BTM202720-1	MKM2020	—	—	19.987	20.000	26.972	26.993	25	28	
	27	23.50	—	18.4	28.8	10 000 ¹⁾	BKM2024JAU	—	—	—	—	19.987	20.000	26.972	26.993	32	—
	27	25	—	22.1	36.6	18 000	BTM202725	—	—	—	—	19.987	20.000	26.972	26.993	33	—
	27	26	—	18.4	28.8	10 000 ¹⁾	BKM2026JUJ	—	—	—	—	19.987	20.000	26.972	26.993	33	—
	27	26	—	27.6	58.0	6 200	—	—	BM2026	—	19.987	20.000	26.972	26.993	40	—	
	27	30	—	21.8	36.0	10 000 ¹⁾	BKM2030JUJ	—	—	—	—	19.987	20.000	26.972	26.993	38	—
27	30	27.3	25.4	43.8	18 000	BTM202730	MKM2030	—	—	19.987	20.000	26.972	26.993	40	45		
27	35	—	28.7	45.4	10 000 ¹⁾	BKM2035JUJ	—	—	—	—	19.987	20.000	26.972	26.993	45	—	
28	20	—	17.4	22.3	17 000	20BTM2820A	—	—	—	—	19.987	20.000	27.991 ⁴⁾	28.012 ⁴⁾	31	—	
21	27	20	—	20.5	47.6	6 100	—	—	21YM2720J	—	20.987	21.000	26.972	26.993	29	—	
22	28	12	9.6	11.6	22.9	5 800	—	—	22BM2812	22MM2812	21.987	22.000	27.972	27.993	16	18	
	28	12	9.3	9.10	13.5	16 000	22BTM2812	22MKM2812	—	—	21.987	22.000	27.972	27.993	14	16	
	28	16	13.7	16.1	35.0	5 800	—	—	22BM2816	22MM2816	21.987	22.000	27.972	27.993	22	25	
	28	16	13.3	12.7	20.8	16 000	22BTM2816A	22MKM2816	—	—	21.987	22.000	27.972	27.993	19	22	
	28	20	17.2	20.3	47.2	5 800	—	—	22BM2820	22MM2820	21.987	22.000	27.972	27.993	29	32	

[Notes] 1) The limiting speeds shown above are applicable when oil seal is used and the bearing is lubricated with grease.

2) FN in bearing number indicates a bearing comprising polyamide molded cage.

3) The recommended dimensional tolerances of shaft shown above are applicable except h6.

4) The recommended dimensional tolerances of housing bore shown above are applicable except N7.

[Remark] Limiting speed of grease lubrication should be kept to under 60 % of that for oil lubrication.

Drawn cup needle roller bearings

Metric series

F_w (22) ~ (25) mm

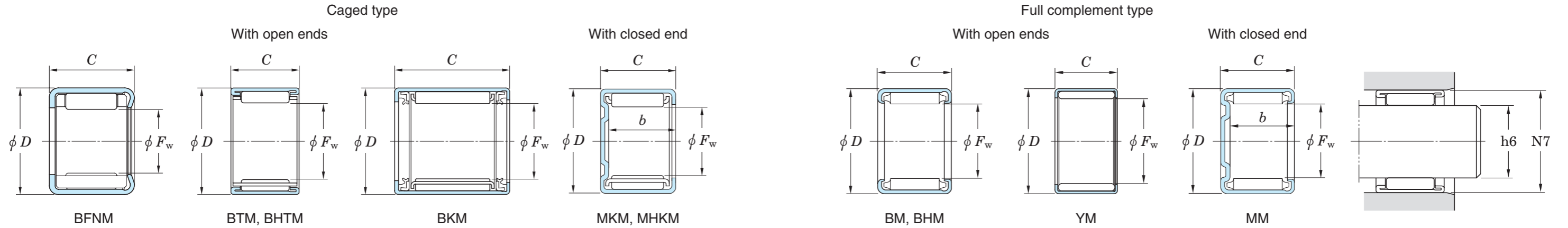

Boundary dimensions (mm)				Basic load ratings (kN)		Limiting speeds (min ⁻¹)	Bearing No. ²⁾				Recommended dimensions (mm)				(Refer.) Mass (g)	
F_w	D	C	$b_{min.}$	C_r	C_{0r}	Oil lub.	Caged type		Full complement type		Shaft dia. (h6)		Housing bore dia. (N7)		With open ends	With closed end
							With open ends	With closed end	With open ends	With closed end	min.	max.	min.	max.		
22	28	20	17.3	14.9	26.5	17 000	22BTM2820	22MKM2820	—	—	21.987	22.000	27.972	27.993	25	28
	28	20	—	21.0	49.5	5 800	—	—	YM222820	—	21.987	22.000	27.972	27.993	30	—
	29	12	—	9.22	13.0	16 000	BTM2212	—	—	—	21.987	22.000	28.972	28.993	19	—
	29	15	—	12.0	18.3	16 000	BTM2215	—	—	—	21.987	22.000	28.972	28.993	22	—
	29	20	—	21.9	45.2	5 700	—	—	BM2220B	—	21.987	22.000	28.972	28.993	33	—
	29	20	17.3	16.2	26.7	16 000	BTM2220A	MKM2220	—	—	21.987	22.000	28.972	28.993	30	33
	29	25	—	20.4	36.1	16 000	BTM2225	—	—	—	21.987	22.000	28.972	28.993	37	—
	30	18	—	16.7	24.5	16 000	22BTM3018	—	—	—	21.987	22.000	29.972	29.993	31	—
24	30	13	—	9.55	15.7	15 000	BTM243013J	—	—	—	23.987	24.000	29.991 ⁴⁾	30.012 ⁴⁾	47	—
	31	20	17.3	17.7	29.4	15 000	BTM2420	MKM2420	—	—	23.987	24.000	30.967	30.992	31	35
	31	25	—	31.6	65.4	5 200	—	—	BM2425A	—	23.987	24.000	30.989 ⁴⁾	31.014 ⁴⁾	45	—
	31	28	—	23.9	43.0	15 000	BTM2428	—	—	—	23.987	24.000	30.967	30.992	44	—
	35	20	18.0	21.0	25.8	14 000	—	24MKM3520	—	—	23.987	24.000	34.967	34.992	—	52
25	31	19	—	16.3	30.1	15 000	25BTM3119A	—	—	—	24.987	25.000	30.967	30.992	26	—
	32	12	9.3	9.05	12.4	14 000	BTM2512	MKM2512	—	—	24.987	25.000	31.967	31.992	19	21
	32	16	—	18.7	37.9	5 100	—	—	BM2516	—	24.987	25.000	31.967	31.992	28	—
	32	16	13.3	15.3	24.6	14 000	BTM2516	MKM2516	—	—	24.987	25.000	31.967	31.992	26	30
	32	20	17.2	23.8	51.7	5 100	—	—	BM2520	MM2520	24.987	25.000	31.967	31.992	36	41
	32	20	—	19.1	32.5	14 000	BTM2520A	MTM2520M	—	—	24.987	25.000	31.967	31.992	33	—
	32	26	—	30.9	72.4	5 100	—	—	BM2526	—	24.987	25.000	31.967	31.992	48	—
	32	26	23.3	23.7	43.1	14 000	BTM2526	MKM2526	—	—	24.987	25.000	31.967	31.992	42	48
	33	10	—	8.50	10.3	14 000	BHTM2510A	—	—	—	24.987	25.000	32.989 ⁴⁾	33.014 ⁴⁾	18	—
	33	15	—	19.5	32.0	5 000	—	—	BHM2515	—	24.987	25.000	32.989 ⁴⁾	33.014 ⁴⁾	30	—
	33	15	—	13.9	19.7	14 000	BHTM2515-1	—	—	—	24.987	25.000	32.967	32.992	27	—
	33	20	17.3	19.2	29.7	14 000	BHTM2520-1	MHKM2520	—	—	24.987	25.000	32.967	32.992	37	41
	33	25	—	31.3	66.3	5 000	—	—	BHM2525	—	24.987	25.000	32.967	32.992	53	—
	33	25	—	24.5	40.6	14 000	BHTM2525	—	—	—	24.987	25.000	32.967	32.992	46	—

[Notes] 1) The limiting speeds shown above are applicable when oil seal is used and the bearing is lubricated with grease.

2) FN in bearing number indicates a bearing comprising polyamide molded cage.

3) The recommended dimensional tolerances of shaft shown above are applicable except h6.

4) The recommended dimensional tolerances of housing bore shown above are applicable except N7.

[Remark] Limiting speed of grease lubrication should be kept to under 60 % of that for oil lubrication.

Drawn cup needle roller bearings

Metric series

F_w (25) ~ (30) mm

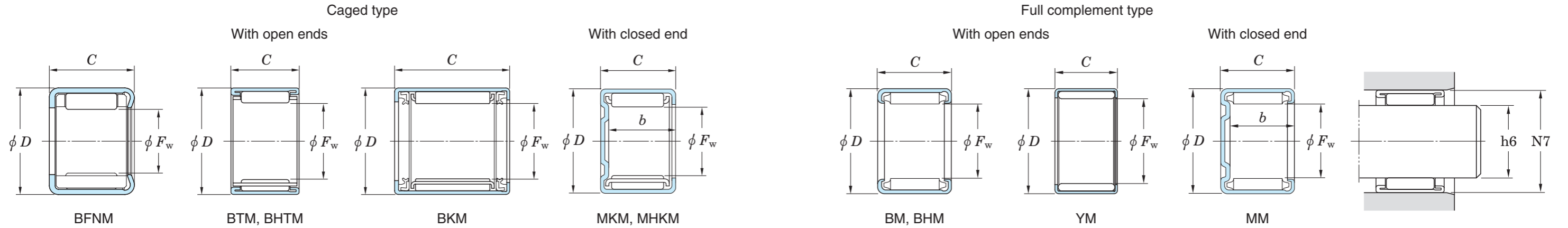

Boundary dimensions (mm)				Basic load ratings (kN)		Limiting speeds (min ⁻¹)	Bearing No. ²⁾				Recommended dimensions (mm)				(Refer.) Mass (g)	
F_w	D	C	$b_{min.}$	C_r	C_{0r}	Oil lub.	Caged type		Full complement type		Shaft dia. (h6)		Housing bore dia. (N7)		With open ends	With closed end
							With open ends	With closed end	With open ends	With closed end	min.	max.	min.	max.		
25	33	30	—	37.4	83.3	5 000	—	—	BHM2530	—	24.987	25.000	32.989 ⁴⁾	33.014 ⁴⁾	65	—
	33	30	27.3	27.7	47.4	14 000	BHTM2530-1	MHKM2530	—	—	24.987	25.000	32.967	32.992	54	61
	33	35	—	29.8	52.3	8 000 ¹⁾	BHKM2535JU	—	—	—	24.987	25.000	32.967	32.992	62	—
25.80	33	16	—	14.2	22.4	14 000	BTM263316A	—	—	—	25.787	25.800	32.967	32.992	28	—
26	31.40	12	—	8.60	14.5	14 000	BKM263112A	—	—	—	25.987	26.000	31.389 ⁴⁾	31.414 ⁴⁾	14	—
	34	16	13.3	15.3	22.5	14 000	BHTM2616	MHKM2616	—	—	25.987	26.000	33.967	33.992	30	34
	34	20	17.3	20.0	31.6	14 000	BHTM2620A	MHKM2620	—	—	25.987	26.000	33.967	33.992	38	43
28	34	17	—	16.8	49.7	4 600	—	—	BM2817	—	27.987	28.000	33.967	33.992	29	—
	34	24	—	29.0	76.7	4 600	—	—	BM2824	—	27.987	28.000	33.967	33.992	42	—
	34	25	—	34.8	85.9	4 600	—	—	YM2825B	—	27.991 ³⁾	28.000 ³⁾	33.975 ⁴⁾	34.000 ⁴⁾	45	—
	35	16	13.7	20.2	42.9	4 600	—	—	28BM3516	28MM3516	27.987	28.000	34.967	34.992	95	107
	35	16	13.3	15.9	26.2	13 000	28BTM3516	28MKM3516	—	—	27.987	28.000	34.967	34.992	28	31
	35	20	17.2	25.7	58.3	4 600	—	—	28BM3520	28MM3520	27.987	28.000	34.967	34.992	118	133
	35	20	17.3	19.0	33.1	13 000	28BTM3520	28MKM3520	—	—	27.987	28.000	34.967	34.992	35	39
	36	20.75	—	22.8	39.3	13 000	BTM283621JA	—	—	—	27.987	28.000	35.967	35.992	43	—
	36	23	—	22.8	39.3	13 000	BTM283623J	—	—	—	27.987	28.000	35.967	35.992	49	—
	37	20	17.3	21.6	33.0	13 000	BTM283720	MHKM2820	—	—	27.987	28.000	36.967	36.992	46	52
	37	30	—	43.7	94.7	4 400	—	—	28BHM3730	—	27.980 ³⁾	27.993 ³⁾	36.989 ⁴⁾	37.014 ⁴⁾	80	—
37	30	27.3	32.8	56.5	13 000	BHTM2830	MHKM2830	—	—	27.987	28.000	36.967	36.992	70	79	
39	30	—	44.5	85.9	4 300	—	—	BM283930A	—	27.980 ³⁾	27.993 ³⁾	38.989 ⁴⁾	39.014 ⁴⁾	100	—	
30	37	12	9.3	12.1	18.8	12 000	BTM303712	30MKM3712	—	—	29.987	30.000	36.967	36.992	22	25
	37	16	—	21.1	28.2	4 300	—	—	30BM3716	—	29.987	30.000	36.967	36.992	33	—
	37	16	13.3	17.1	29.3	12 000	30BTM3716BM	30MKM3716	—	—	29.987	30.000	36.967	36.992	30	33
	37	20	17.2	26.8	62.5	4 300	—	—	30BM3720	30MM3720	29.987	30.000	36.967	36.992	42	48
	37	20	17.3	20.7	40.4	12 000	30BTM3720	30MKM3720	—	—	29.987	30.000	36.967	36.992	40	45
	37	20	—	32.2	70.1	4 300	—	—	30YM3720	—	29.987	30.000	36.967	36.992	45	—

[Notes] 1) The limiting speeds shown above are applicable when oil seal is used and the bearing is lubricated with grease.

2) FN in bearing number indicates a bearing comprising polyamide molded cage.

3) The recommended dimensional tolerances of shaft shown above are applicable except h6.

4) The recommended dimensional tolerances of housing bore shown above are applicable except N7.

[Remark] Limiting speed of grease lubrication should be kept to under 60 % of that for oil lubrication.

Drawn cup needle roller bearings

Metric series

F_w (30) ~ (35) mm

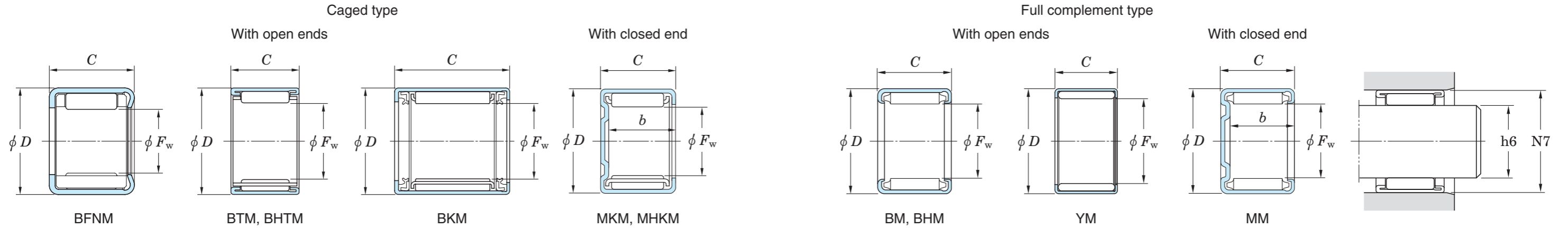

Boundary dimensions (mm)				Basic load ratings (kN)		Limiting speeds (min ⁻¹)	Bearing No. ²⁾				Recommended dimensions (mm)				(Refer.) Mass (g)	
F_w	D	C	$b_{min.}$	C_r	C_{0r}	Oil lub.	Caged type		Full complement type		Shaft dia. (h6)		Housing bore dia. (N7)		With open ends	With closed end
							With open ends	With closed end	With open ends	With closed end	min.	max.	min.	max.		
30	37	26	—	34.8	87.3	4 300	—	—	30BM3726	—	29.987	30.000	36.967	36.992	56	—
	37	26	23.3	26.7	52.0	12 000	30BTM3726	30MKM3726	—	—	29.987	30.000	36.967	36.992	48	55
	37	26	—	37.1	94.9	4 300	—	—	30YM3726	—	29.987	30.000	36.967	36.992	60	—
	38	21	—	23.4	40.4	12 000	BTM3021A	—	—	—	29.987	30.000	37.967	37.992	45	—
	38	25	—	38.0	79.8	4 200	—	—	BM3025	—	29.987	30.000	37.989 ⁴⁾	38.014 ⁴⁾	62	—
	40	15	—	16.6	22.3	12 000	BHTM3015	—	—	—	29.987	30.000	39.967	39.992	41	—
	40	20	17.3	23.1	34.0	12 000	BHTM3020	MHKM3020	—	—	29.987	30.000	39.967	39.992	55	62
	40	25	—	37.3	75.4	4 100	—	—	BHM3025	—	29.987	30.000	39.987 ⁴⁾	40.013 ⁴⁾	80	—
	40	25	—	29.4	46.5	12 000	BHTM3025-1	—	—	—	29.987	30.000	39.967	39.992	69	—
	40	30	27.3	35.3	58.8	12 000	BHTM3030-1A	MHKM3030	—	—	29.987	30.000	39.967	39.992	83	94
40	30	—	30.8	49.3	6 600 ¹⁾	BKM304030JU	—	—	—	29.987	30.000	39.967	39.992	77	—	
31	39	17.80	—	20.6	34.6	12 000	31BTM3918A	—	—	—	30.984	31.000	38.967	38.992	39	—
32	38	11	—	4.90	6.75	12 000	32BTM3811A	—	—	—	31.975 ³⁾	31.991 ³⁾	38.000 ⁴⁾	38.025 ⁴⁾	15	—
	40	20	—	31.9	73.3	4 000	—	—	32YM4020P	—	31.984	32.000	39.989 ⁴⁾	40.014 ⁴⁾	56	—
	40	25	—	27.6	50.8	11 000	32BTM4025PL	—	—	—	31.984	32.000	39.989 ⁴⁾	40.014 ⁴⁾	57	—
	42	20	17.3	23.4	34.8	11 000	BHTM3220A	MHKM3220	—	—	31.984	32.000	41.989 ⁴⁾	42.014 ⁴⁾	57	64
	42	20	—	37.4	69.1	3 900	—	—	YM3220	—	31.995 ³⁾	32.011 ³⁾	41.989 ⁴⁾	42.014 ⁴⁾	71	—
	42	30	27.3	36.6	61.9	11 000	BHTM3230	MHKM3230	—	—	31.984	32.000	41.967	41.992	86	98
42	30	—	55.0	113	3 900	—	—	YM3230	—	31.995 ³⁾	32.011 ³⁾	41.989 ⁴⁾	42.014 ⁴⁾	109	—	
33.50	40	17	—	16.8	33.5	11 000	BTM344017A	—	—	—	33.484	33.500	39.967	39.992	34	—
34	40	12	—	7.30	11.7	11 000	34BTM4012A	—	—	—	33.984	34.000	39.967	39.992	20	—
	42	25	—	37.2	94.1	3 800	—	—	34YM4225	—	33.959 ³⁾	33.975 ³⁾	41.967	41.992	74	—
35	40.50	26	—	22.7	56.0	11 000	BSM354126AJ	—	—	—	34.984	35.000	40.467	40.492	44	—
	42	12	—	13.3	22.8	11 000	BTM3512	—	—	—	34.984	35.000	41.967	41.992	26	—
	42	16	—	22.2	52.9	3 700	—	—	BM3516	—	34.984	35.000	41.967	41.992	38	—

[Notes] 1) The limiting speeds shown above are applicable when oil seal is used and the bearing is lubricated with grease.

2) FN in bearing number indicates a bearing comprising polyamide molded cage.

3) The recommended dimensional tolerances of shaft shown above are applicable except h6.

4) The recommended dimensional tolerances of housing bore shown above are applicable except N7.

[Remark] Limiting speed of grease lubrication should be kept to under 60 % of that for oil lubrication.

Drawn cup needle roller bearings

Metric series

F_w (35) ~ (40) mm

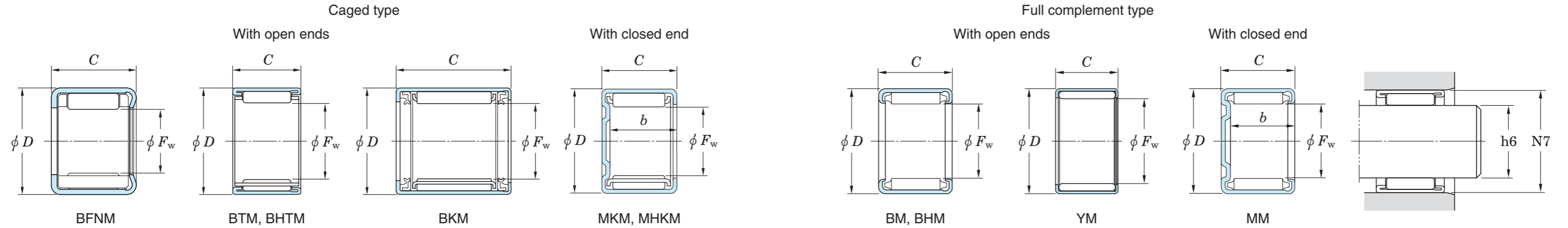

Boundary dimensions (mm)				Basic load ratings (kN)		Limiting speeds (min ⁻¹)	Bearing No. ²⁾				Recommended dimensions (mm)				(Refer.) Mass (g)	
F_w	D	C	$b_{min.}$	C_r	C_{0r}	Oil lub.	Caged type		Full complement type		Shaft dia. (h6)		Housing bore dia. (N7)		With open ends	With closed end
							With open ends	With closed end	With open ends	With closed end	min.	max.	min.	max.		
35	42	16	13.3	18.5	34.7	11 000	BTM3516	MKM3516	—	—	34.984	35.000	41.967	41.992	35	39
	42	20	—	13.3	22.8	5 700 ¹⁾	BKM354220-1UU	—	—	—	34.984	35.000	41.967	41.992	38	—
	42	20	17.2	28.2	72.2	3 700	—	—	BM3520	MM3520	34.984	35.000	41.967	41.992	49	56
	42	20	17.3	23.4	47.0	11 000	BTM3520	MKM3520	—	—	34.984	35.000	41.989 ⁴⁾	42.014 ⁴⁾	43	49
	42	21	—	28.8	79.2	3 700	—	—	YM3521A	—	34.984	35.000	41.989 ⁴⁾	42.014 ⁴⁾	55	—
	42	26	—	36.7	101	3 700	—	—	BM3526	—	34.984	35.000	41.967	41.992	66	—
	42	26	23.3	30.1	65.2	11 000	BTM3526	MKM3526	—	—	34.984	35.000	41.967	41.992	57	64
	42	28	—	31.3	68.6	11 000	BTM3528	—	—	—	34.984	35.000	41.967	41.992	63	—
	42	46	—	26.2	57.5	5 700 ¹⁾	BKM354246UUH	—	—	—	34.984	35.000	41.967	41.992	101	—
	45	15	—	18.4	26.6	10 000	BHTM3515	—	—	—	34.984	35.000	44.967	44.992	47	—
	45	18	—	20.5	33.4	3 600	—	—	BHM3518	—	34.984	35.000	44.967	44.992	62	—
	45	20	17.3	26.0	41.7	10 000	BHTM3520	MHKM3520	—	—	34.984	35.000	44.967	44.992	64	72
	45	25	—	32.8	56.2	10 000	BHTM3525	—	—	—	34.984	35.000	44.967	44.992	80	—
	45	30	27.3	39.4	71.0	10 000	BHTM3530	MHKM3530	—	—	34.984	35.000	44.967	44.992	96	109
36	42	16	—	19.6	55.9	3 700	—	—	36BM4216	—	35.984	36.000	41.967	41.992	35	—
	44	25	—	42.0	99.2	3 600	—	—	36YM4425L	—	35.975 ³⁾	35.991 ³⁾	43.967	43.992	78	—
	48	24	—	33.2	48.7	9 800	36BTM4824	—	—	—	35.984	36.000	47.967	47.992	95	—
37	43	12	—	8.00	13.6	10 000	37BTM4312A	—	—	—	36.984	37.000	42.967	42.992	23	—
	47	20	17.3	25.1	39.9	9 800	BTM3720	MKM3720	—	—	36.984	37.000	46.967	46.992	64	72
	47	30	27.3	38.2	68.4	9 800	BTM3730	MKM3730	—	—	36.984	37.000	46.967	46.992	96	109
38	45	12	—	12.7	23.0	9 800	BTM384512A	—	—	—	37.984	38.000	44.967	44.992	29	—
	48	20	17.3	27.1	44.5	9 500	BTM3820A	MKM3820	—	—	37.984	38.000	47.967	47.992	67	76
	48	20	—	42.0	82.8	3 300	—	—	YM3820P	—	37.984	38.000	47.967	47.992	82	—
	48	30	27.3	41.2	76.2	9 500	BTM3830PL	MKM3830	—	—	37.984	38.000	47.967	47.992	102	115
	48	45	—	58.9	121	9 500	BTM3845-OH	—	—	—	37.984	38.000	47.967	47.992	151	—
40	47	12	—	9.75	10.4	9 400	40BTM4712A	—	—	—	39.984	40.000	46.967	46.992	27	—

[Notes] 1) The limiting speeds shown above are applicable when oil seal is used and the bearing is lubricated with grease.

2) FN in bearing number indicates a bearing comprising polyamide molded cage.

3) The recommended dimensional tolerances of shaft shown above are applicable except h6.

4) The recommended dimensional tolerances of housing bore shown above are applicable except N7.

[Remark] Limiting speed of grease lubrication should be kept to under 60 % of that for oil lubrication.

Drawn cup needle roller bearings

Metric series

F_w (40) ~ 45 mm

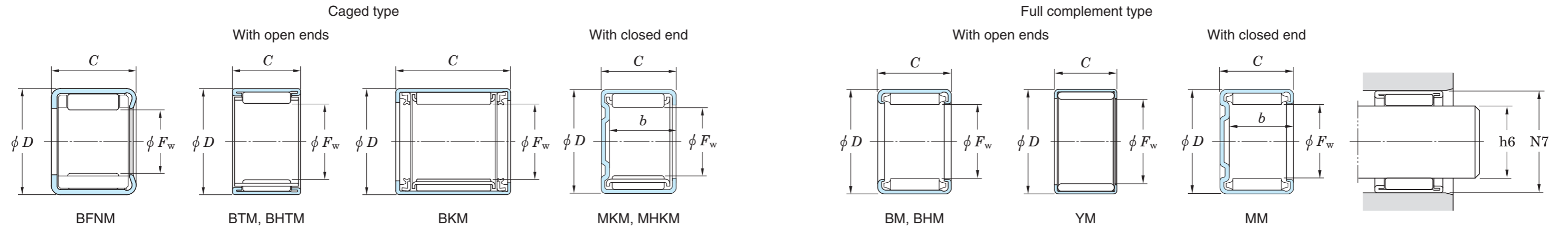

Boundary dimensions (mm)				Basic load ratings (kN)		Limiting speeds (min ⁻¹)	Bearing No. ²⁾				Recommended dimensions (mm)				(Refer.) Mass (g)	
F_w	D	C	$b_{min.}$	C_r	C_{0r}	Oil lub.	Caged type		Full complement type		Shaft dia. (h6)		Housing bore dia. (N7)		With open ends	With closed end
							With open ends	With closed end	With open ends	With closed end	min.	max.	min.	max.		
40	47	16	—	23.8	60.5	3 300	—	—	40BM4716	—	39.984	40.000	46.967	46.992	43	—
	47	16	13.3	18.7	37.1	9 400	40BTM4716	40MKM4716	—	—	39.984	40.000	46.967	46.992	39	44
	47	20	17.2	30.3	82.6	3 300	—	—	40BM4720	40MM4720	39.984	40.000	46.967	46.992	56	63
	47	20	17.3	23.7	50.4	9 400	40BTM4720	40MKM4720	—	—	39.984	40.000	46.967	46.992	48	55
	50	15	—	23.4	45.2	3 200	—	—	BM4015-1	—	39.984	40.000	49.967	49.992	55	—
	50	15	—	20.2	31.2	9 100	BTM4015	—	—	—	39.984	40.000	49.967	49.992	54	—
	50	20	17.3	28.5	48.5	9 100	BTM4020	MKM4020	—	—	39.984	40.000	49.967	49.992	73	82
	50	25	—	36.2	66.2	9 100	BTM4025	—	—	—	39.984	40.000	49.967	49.992	91	—
	50	30	27.3	43.0	82.5	9 100	BTM4030-1	MKM4030	—	—	39.984	40.000	49.967	49.992	109	123
	50	40	—	54.8	113	9 100	BTM4040-OH	—	—	—	39.984	40.000	49.967	49.992	141	—
	51	20	—	40.2	84.7	3 200	—	—	YM405120J	—	39.984	40.000	50.961	50.991	96	—
	51	30	—	43.5	76.6	9 000	40BTM5130J	—	—	—	39.984	40.000	50.961	50.991	112	—
	53	20	—	46.7	87.3	3 100	—	—	YM405320JM	—	39.984	40.000	52.961	52.991	114	—
41.50	46.50	8.50	—	7.00	13.9	9 200	BTM424709AJ	—	—	—	41.484	41.500	46.467	46.492	15	—
42	53	30	—	45.7	83.9	8 600	BTM425330J	—	—	—	41.984	42.000	52.961	52.991	121	—
43	49	12	—	8.35	15.1	8 800	43BTM4912A	—	—	—	42.984	43.000	48.989 ⁴⁾	49.014 ⁴⁾	25	—
43.52	48.52	14	—	12.0	29.0	8 800	44BTM4914A	—	—	—	43.504	43.520	48.487	48.512	28	—
45	52	12	—	13.7	26.9	8 400	45BTM5212A	—	—	—	44.984	45.000	51.961	51.991	34	—
	52	16	—	23.8	65.9	2 900	—	—	45BM5216	—	44.984	45.000	51.961	51.991	49	—
	52	16	13.3	19.1	41.3	8 400	45BTM5216	45MKM5216	—	—	44.984	45.000	51.961	51.991	45	51
	52	20	17.2	30.4	90.1	2 900	—	—	45BM5220	45MM5220	44.984	45.000	51.961	51.991	62	71
	52	20	17.3	23.3	33.4	8 200	45BTM5220A	MKM4520	—	—	44.984	45.000	54.961	54.991	79	90
	52	30	27.3	45.3	91.7	8 200	BTM4530	MKM4530	—	—	44.984	45.000	54.961	54.991	120	136
	55	20	—	30.0	53.9	8 200	BTM4520A	—	—	—	44.984	45.000	54.961	54.991	79	—

[Notes] 1) The limiting speeds shown above are applicable when oil seal is used and the bearing is lubricated with grease.

2) FN in bearing number indicates a bearing comprising polyamide molded cage.

3) The recommended dimensional tolerances of shaft shown above are applicable except h6.

4) The recommended dimensional tolerances of housing bore shown above are applicable except N7.

[Remark] Limiting speed of grease lubrication should be kept to under 60 % of that for oil lubrication.

Drawn cup needle roller bearings

Metric series

F_w 48 ~ 76.50 mm

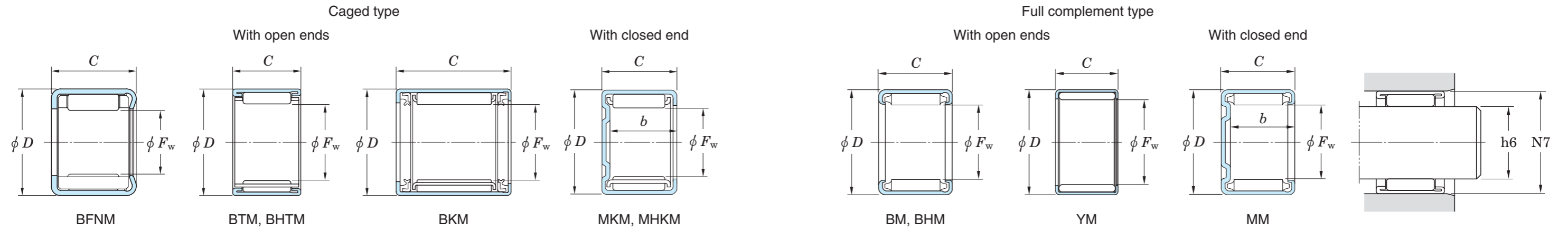

Boundary dimensions (mm)				Basic load ratings (kN)		Limiting speeds (min ⁻¹)	Bearing No. ²⁾				Recommended dimensions (mm)				(Refer.) Mass (g)	
F_w	D	C	b min.	C_r	C_{0r}	Oil lub.	Caged type		Full complement type		Shaft dia. (h6)		Housing bore dia. (N7)		With open ends	With closed end
							With open ends	With closed end	With open ends	With closed end	min.	max.	min.	max.		
48	56	30	—	41.0	100	7 800	BTM485630J	—	—	—	47.984	48.000	55.961	55.991	102	—
50	58	16	—	21.9	43.8	7 500	BTM505816J	—	—	—	49.984	50.000	57.961	57.991	54	—
	58	20	—	35.8	98.0	2 600	—	—	50BM5820	—	49.984	50.000	57.961	57.991	78	—
	58	20	17.3	28.4	61.0	7 500	50BTM5820J	50MKM5820	—	—	49.984	50.000	57.961	57.991	68	76
	58	25	—	45.2	133	2 600	—	—	50BM5825	—	49.984	50.000	57.961	57.991	98	—
	58	25	22.3	35.9	82.5	7 500	50BTM5825	50MKM5825	—	—	49.984	50.000	57.961	57.991	86	97
	62	15	—	24.3	36.4	7 300	BTM5015	—	—	—	49.984	50.000	61.961	61.991	73	—
	62	20	17.3	34.5	57.1	7 300	BTM5020	MKM5020	—	—	49.984	50.000	61.961	61.991	99	112
	62	25	—	43.9	77.8	7 300	BTM5025	—	—	—	49.984	50.000	61.961	61.991	125	—
62	30	27.3	52.8	98.5	7 300	BTM5030	MKM5030	—	—	49.984	50.000	61.961	61.991	153	173	
55	63	20	—	29.1	65.1	6 900	55BTM6320	—	—	—	54.981	55.000	62.961	62.991	73	—
	67	20	—	36.4	63.1	6 700	55BTM6720A	—	—	—	54.981	55.000	66.961	62.991	110	—
64	73.178	21.10	—	36.1	83.8	5 900	64BTM7321A	—	—	—	63.981	64.000	73.139	73.129	110	—
66	72	16	—	21.9	61.1	5 900	BTM667216J	—	—	—	65.981	66.000	71.961	71.991	54	—
71.60	78.60	15	—	22.9	61.9	5 400	BTM727915AJ	—	—	—	71.581	71.600	78.561	78.591	66	—
76.50	83.50	15	—	23.5	65.4	5 000	BTM778415AJ	—	—	—	76.481	76.500	83.455	83.490	70	—

[Notes] 1) The limiting speeds shown above are applicable when oil seal is used and the bearing is lubricated with grease.
 2) FN in bearing number indicates a bearing comprising polyamide molded cage.
 3) The recommended dimensional tolerances of shaft shown above are applicable except h6.
 4) The recommended dimensional tolerances of housing bore shown above are applicable except N7.

[Remark] Limiting speed of grease lubrication should be kept to under 60 % of that for oil lubrication.

Drawn cup needle roller bearings

Inch series

F_w 7.938 ~ (12.700) mm

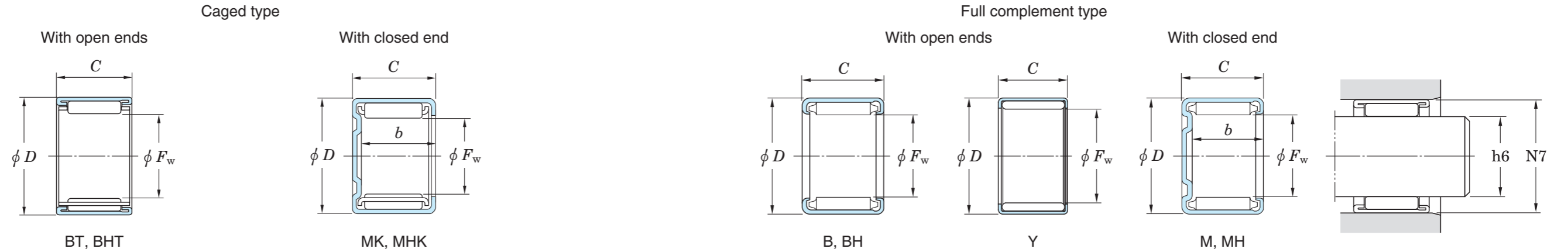

Boundary dimensions							Basic load ratings (kN)		Limiting speeds (min ⁻¹)	Bearing No. ¹⁾				Recommended dimensions (mm)				(Refer.) Mass (g)	
F_w		D		C		b	C_r	C_{0r}	Oil lub.	Caged type		Full complement type		Shaft dia. (h6)		Housing bore dia. (J7)		With open ends	With closed end
mm	inch	mm	inch	mm	inch	min.				With open ends	With closed end	With open ends	With closed end	min.	max.	min.	max.	ends	end
7.938	⁵ / ₁₆	12.700	¹ / ₂	7.940	⁵ / ₁₆	5.8	3.55	4.50	13 000	—	—	B55	M551	7.929	7.938	12.692	12.710	3.5	4.0
	⁵ / ₁₆	12.700	¹ / ₂	7.940	⁵ / ₁₆	5.8	2.60	2.55	36 000	BT55	MK551	—	—	7.925 ²⁾	7.938 ²⁾	12.692	12.710	3.4	3.9
	⁵ / ₁₆	12.700	¹ / ₂	7.940	⁵ / ₁₆	—	4.05	5.35	13 000	—	—	Y55	—	7.929	7.938	12.692	12.710	3.8	—
	⁵ / ₁₆	12.700	¹ / ₂	11.110	⁷ / ₁₆	8.8	5.55	7.95	13 000	—	—	B57	M571	7.929	7.938	12.692	12.710	5.0	5.6
	⁵ / ₁₆	12.700	¹ / ₂	11.110	⁷ / ₁₆	8.8	4.25	4.75	36 000	BT57	MK571	—	—	7.925 ²⁾	7.938 ²⁾	12.692	12.710	4.5	5.1
	⁵ / ₁₆	12.700	¹ / ₂	11.110	⁷ / ₁₆	—	5.95	8.75	13 000	—	—	Y57	—	7.929	7.938	12.692	12.710	5.3	—
	⁵ / ₁₆	12.700	¹ / ₂	14.290	⁹ / ₁₆	12.1	7.35	11.5	13 000	—	—	B59	M591	7.929	7.938	12.692	12.710	6.7	7.5
	⁵ / ₁₆	14.288	⁹ / ₁₆	11.110	⁷ / ₁₆	8.6	4.25	3.90	35 000	BHT57	MHK571	—	—	7.929	7.938	14.280	14.298	6.8	7.6
9.525	³ / ₈	14.288	⁹ / ₁₆	7.940	⁵ / ₁₆	5.8	3.95	5.45	12 000	—	—	B65	M651	9.516	9.525	14.280	14.298	4.1	4.6
	³ / ₈	14.288	⁹ / ₁₆	7.940	⁵ / ₁₆	5.8	2.80	2.85	33 000	BT65	MK651	—	—	9.512 ²⁾	9.525 ²⁾	14.280	14.298	3.9	4.4
	³ / ₈	14.288	⁹ / ₁₆	7.940	⁵ / ₁₆	—	4.50	6.40	12 000	—	—	Y65	—	9.516	9.525	14.280	14.298	4.4	—
	³ / ₈	14.288	⁹ / ₁₆	9.520	³ / ₈	7.3	5.15	7.60	12 000	—	—	B66	M661	9.512 ²⁾	9.525 ²⁾	14.280	14.298	4.8	5.4
	³ / ₈	14.288	⁹ / ₁₆	9.520	³ / ₈	7.3	3.65	4.05	33 000	BT66	MK661	—	—	9.512 ²⁾	9.525 ²⁾	14.280	14.298	4.7	5.3
	³ / ₈	14.288	⁹ / ₁₆	9.520	³ / ₈	—	5.60	8.45	12 000	—	—	Y66	—	9.516	9.525	14.280	14.298	5.3	—
	³ / ₈	14.288	⁹ / ₁₆	12.700	¹ / ₂	10.4	7.25	11.8	12 000	—	—	B68-1	M681	9.516	9.525	14.280	14.298	6.7	7.6
	³ / ₈	14.288	⁹ / ₁₆	12.700	¹ / ₂	10.4	5.25	6.45	33 000	BT68	MK681	—	—	9.516	9.525	14.280	14.298	6.1	6.9
	³ / ₈	14.288	⁹ / ₁₆	12.700	¹ / ₂	—	8.10	13.6	12 000	—	—	Y68	—	9.516	9.525	14.280	14.298	7.1	—
	³ / ₈	14.288	⁹ / ₁₆	15.880	⁵ / ₈	13.7	9.10	15.8	12 000	—	—	B610-1	M6101	9.516	9.525	14.280	14.298	8.5	9.6
³ / ₈	15.875	⁵ / ₈	12.700	¹ / ₂	10.1	7.85	10.6	11 000	—	—	BH68	MH681	9.516	9.525	15.867	15.885	9.3	11	
11.112	⁷ / ₁₆	15.875	⁵ / ₈	11.110	⁷ / ₁₆	—	6.80	11.3	10 000	—	—	B77	—	11.101	11.112	15.867	15.885	6.5	—
	⁷ / ₁₆	15.875	⁵ / ₈	12.700	¹ / ₂	10.4	7.95	13.8	10 000	—	—	B78	M781	11.101	11.112	15.867	15.885	7.6	8.6
	⁷ / ₁₆	15.875	⁵ / ₈	12.700	¹ / ₂	10.4	5.75	7.60	29 000	BT78	MK781	—	—	11.099 ²⁾	11.112 ²⁾	15.867	15.885	6.9	7.8
12.700	¹ / ₂	17.462	¹¹ / ₁₆	7.940	⁵ / ₁₆	5.8	4.75	7.45	9 400	—	—	B85	M851	12.689	12.700	17.454	17.472	4.9	5.6
	¹ / ₂	17.462	¹¹ / ₁₆	7.940	⁵ / ₁₆	5.8	3.40	4.05	27 000	BT85	MK851	—	—	12.689	12.700	17.454	17.472	4.7	5.3
	¹ / ₂	17.462	¹¹ / ₁₆	9.520	³ / ₈	7.3	6.10	10.1	9 400	—	—	B86	M861	12.689	12.700	17.454	17.472	6.1	6.9
	¹ / ₂	17.462	¹¹ / ₁₆	11.110	⁷ / ₁₆	8.8	5.40	7.25	27 000	BT87	MK871	—	—	12.689	12.700	17.454	17.472	6.6	7.4
	¹ / ₂	17.462	¹¹ / ₁₆	12.700	¹ / ₂	10.4	8.55	15.7	9 400	—	—	B88	M881	12.689	12.700	17.454	17.472	8.5	9.6

[Notes] 1) FN in bearing number indicates a bearing comprising polyamide molded cage.
 2) The recommended dimensional tolerances of shaft shown above are applicable except h6.
 3) The recommended dimensional tolerances of housing bore shown above are applicable except J7.

[Remark] Limiting speed of grease lubrication should be kept to under 60 % of that for oil lubrication.

Drawn cup needle roller bearings

Inch series

F_w (12.700) ~ (15.875) mm

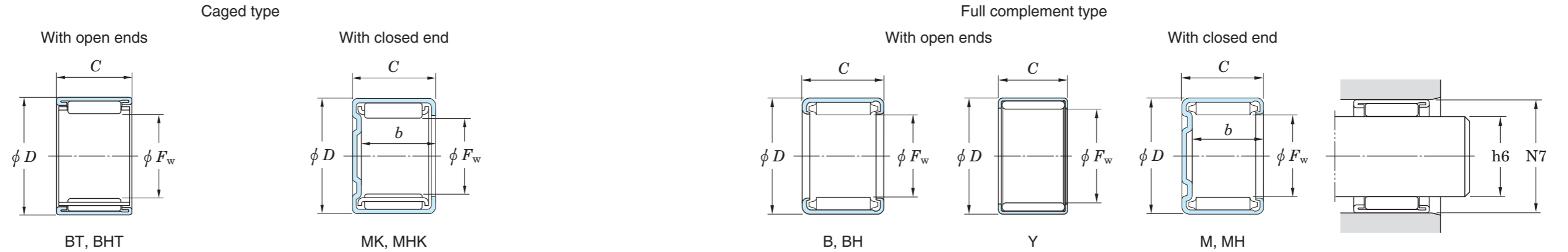

Boundary dimensions							Basic load ratings (kN)		Limiting speeds (min ⁻¹)	Bearing No. ¹⁾				Recommended dimensions (mm)				(Refer.) Mass (g)	
F_w	D	C	b	C_r	C_{0r}	Oil lub.	Caged type		Full complement type		Shaft dia. (h6)		Housing bore dia. (J7)		With open ends	With closed end			
							mm	inch	mm	inch	mm	inch	min.	max.			min.	max.	
12.700	1/2	17.462	11/16	12.700	1/2	10.4	6.25	8.80	27 000	BT88-1	MK881	—	—	12.689	12.700	17.454	17.472	7.7	8.7
	1/2	17.462	11/16	15.880	5/8	—	11.9	24.0	9 400	—	—	Y810	—	12.689	12.700	17.454	17.472	12	—
	1/2	17.462	11/16	19.050	3/4	16.7	13.0	26.8	9 400	—	—	B812	M8121	12.689	12.700	17.454	17.472	13	15
	1/2	17.462	11/16	19.050	3/4	16.7	9.70	15.5	27 000	BT812	MK8121	—	—	12.689	12.700	17.454	17.472	12	13
	1/2	17.462	11/16	19.050	3/4	—	13.8	29.1	9 400	—	—	Y812	—	12.689	12.700	17.454	17.472	13	—
	1/2	19.050	3/4	12.700	1/2	10.4	7.40	8.70	26 000	BHT88	MHK881	—	—	12.689	12.700	19.041	19.062	11	12
	1/2	19.050	3/4	19.050	3/4	16.5	11.3	15.0	26 000	BHT812	MHK8121	—	—	12.689	12.700	19.041	19.062	16	18
14.288	9/16	19.050	3/4	7.940	5/16	5.8	5.00	8.15	8 800	—	—	B95	M951	14.277	14.288	19.041	19.062	5.7	6.5
	9/16	19.050	3/4	9.520	3/8	—	6.45	11.4	8 800	—	—	B96-1	—	14.277	14.288	19.041	19.062	6.7	—
	9/16	19.050	3/4	9.520	3/8	7.3	4.75	6.40	25 000	BT96P	MK961	—	—	14.277	14.288	19.041	19.062	6.5	7.3
	9/16	19.050	3/4	12.700	1/2	10.4	9.10	17.7	8 800	—	—	B98	M981	14.277	14.288	19.041	19.062	9.2	10
	9/16	19.050	3/4	12.700	1/2	10.4	6.80	10.2	25 000	BT98	MK981	—	—	14.277	14.288	19.041	19.062	8.1	9.2
	9/16	19.050	3/4	12.700	1/2	—	10.1	20.4	8 800	—	—	Y98	—	14.277	14.288	19.041	19.062	9.9	—
	9/16	19.050	3/4	15.880	5/8	13.7	11.4	23.7	8 800	—	—	B910	M9101	14.277	14.288	19.041	19.062	12	13
	9/16	19.050	3/4	15.880	5/8	13.7	8.55	13.7	25 000	BT910	MK9101	—	—	14.277	14.288	19.041	19.062	10	12
	9/16	20.638	13/16	12.700	1/2	16.5	7.85	9.65	24 000	BHT98	MHK981	—	—	14.277	14.288	20.629	20.650	11	13
9/16	20.638	13/16	19.050	3/4	16.5	15.9	28.6	8 400	—	—	BH912	MH9121	14.277	14.288	20.629	20.650	19	22	
15.875	5/8	20.638	13/16	7.940	5/16	5.8	5.40	9.30	8 000	—	—	B105	M1051	15.864	15.875	20.629	20.650	5.9	6.7
	5/8	20.638	13/16	7.940	5/16	5.8	3.30	4.15	23 000	BT105	MK1051	—	—	15.864	15.875	20.629	20.650	5.5	6.2
	5/8	20.638	13/16	7.940	5/16	—	6.00	10.7	8 000	—	—	Y105	—	15.864	15.875	20.629	20.650	6.7	—
	5/8	20.638	13/16	11.110	7/16	8.8	5.30	7.55	23 000	BT107	MK1071	—	—	15.864	15.875	20.629	20.650	7.7	8.7
	5/8	20.638	13/16	12.700	1/2	10.4	9.65	19.7	8 000	—	—	B108	M1081	15.864	15.875	20.629	20.650	10	12
	5/8	20.638	13/16	12.700	1/2	—	6.10	9.00	23 000	BT108A	—	—	—	15.862 ²⁾	15.875 ²⁾	20.629	20.650	8.8	—
	5/8	20.638	13/16	12.700	1/2	—	10.7	22.6	8 000	—	—	Y108	—	15.864	15.875	20.629	20.650	11	—
	5/8	20.638	13/16	19.050	3/4	—	9.45	15.9	23 000	BT1012	—	—	—	15.864	15.875	20.629	20.650	13	—
	5/8	20.638	13/16	19.050	3/4	—	15.1	35.0	8 000	—	—	Y1012	—	15.864	15.875	20.629	20.650	16	—
5/8	20.638	13/16	25.400	1	22.8	12.3	22.4	23 000	BT1016	MK10161	—	—	15.864	15.875	20.629	20.650	18	20	

[Notes] 1) FN in bearing number indicates a bearing comprising polyamide molded cage.
 2) The recommended dimensional tolerances of shaft shown above are applicable except h6.
 3) The recommended dimensional tolerances of housing bore shown above are applicable except J7.

[Remark] Limiting speed of grease lubrication should be kept to under 60 % of that for oil lubrication.

Drawn cup needle roller bearings

Inch series

F_w (15.875) ~ (19.050) mm

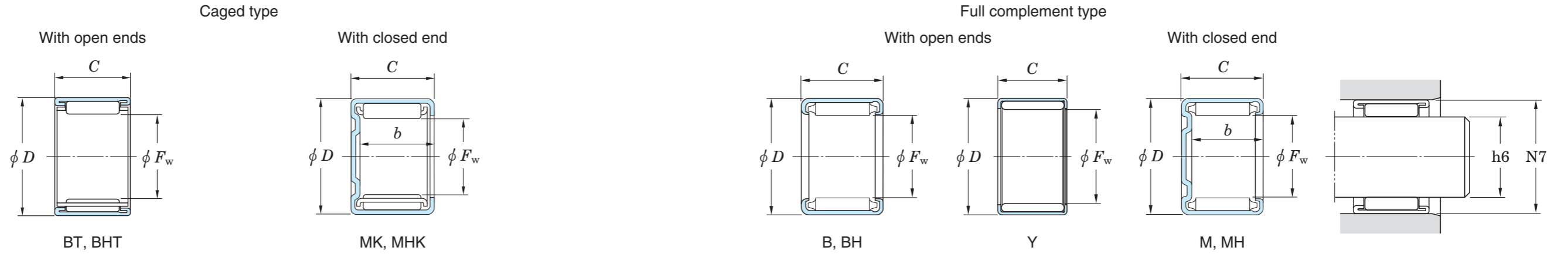

Boundary dimensions							Basic load ratings (kN)		Limiting speeds (min ⁻¹)	Bearing No. ¹⁾				Recommended dimensions (mm)				(Refer.) Mass (g)	
F_w	D	C	b	C_r	C_{0r}	Oil lub.	Caged type		Full complement type		Shaft dia. (h6)		Housing bore dia. (J7)		With open ends	With closed end			
							mm	inch	mm	inch	mm	inch	min.	With open ends			With closed end	min.	max.
15.875	5/8	22.225	7/8	12.700	1/2	10.1	10.9	18.1	7 700	—	—	BH108	MH1081	15.864	15.875	22.216	22.237	14	16
	5/8	22.225	7/8	12.700	1/2	10.1	8.25	10.6	22 000	BHT108	MHK1081	—	—	15.864	15.875	22.216	22.237	12	14
	5/8	22.225	7/8	19.050	3/4	16.5	17.0	32.0	7 700	—	—	BH1012	MH10121	15.864	15.875	22.216	22.237	22	24
	5/8	22.225	7/8	25.400	1	—	22.5	45.8	7 700	—	—	BH1016	—	15.864	15.875	22.216	22.237	28	—
	5/8	22.225	7/8	25.400	1	16.5	16.6	25.9	22 000	BHT1016	MHK10161	—	—	15.864	15.875	22.216	22.237	24	28
17.462	11/16	22.225	7/8	9.520	3/8	7.3	7.25	14.0	7 300	—	—	B116E	M1161	17.451	17.462	22.216	22.237	7.9	8.9
	11/16	22.225	7/8	12.700	1/2	10.4	10.2	21.7	7 300	—	—	B118	M1181	17.449 ²⁾	17.462 ²⁾	22.216	22.237	11	13
	11/16	22.225	7/8	12.700	1/2	—	10.7	23.2	7 300	—	—	Y118	—	17.451	17.462	22.216	22.237	12	—
	11/16	22.225	7/8	15.880	5/8	13.2	12.8	29.0	7 300	—	—	B1110	M11101	17.451	17.462	22.216	22.237	14	15
	11/16	22.225	7/8	15.880	5/8	13.7	9.15	15.7	21 000	BT1110	MK11101	—	—	17.451	17.462	22.216	22.237	12	13
	11/16	22.225	7/8	19.050	3/4	16.7	15.3	36.7	7 300	—	—	B1112	M11121	17.451	17.462	22.216	22.237	16	19
	11/16	22.225	7/8	19.050	3/4	16.7	11.5	21.2	21 000	BT1112-1	MK11121	—	—	17.449 ²⁾	17.462 ²⁾	22.216	22.237	14	16
	11/16	22.225	7/8	19.050	3/4	—	15.9	38.5	7 300	—	—	Y1112	—	17.451	17.462	22.216	22.237	18	—
	11/16	23.812	15/16	15.880	5/8	13.2	14.9	27.5	7 100	—	—	BH1110	MH11101	17.451	17.462	23.803	23.824	19	21
	11/16	23.812	15/16	15.880	5/8	13.2	10.8	15.2	20 000	BHT1110	MHK11101	—	—	17.449 ²⁾	17.462 ²⁾	23.803	23.824	16	18
	11/16	23.812	15/16	19.050	3/4	—	18.0	35.1	7 100	—	—	BH1112	—	17.451	17.462	23.803	23.824	23	—
11/16	23.812	15/16	19.050	3/4	16.5	13.9	21.2	20 000	BHT1112	MHK11121	—	—	17.451	17.462	23.803	23.824	20	22	
19.050	3/4	25.400	1	9.520	3/8	6.8	6.35	7.95	19 000	BT126	MK1261	—	—	19.037	19.050	25.391	25.412	10	12
	3/4	25.400	1	9.520	3/8	—	8.55	13.9	6 500	—	—	Y126	—	19.037	19.050	25.391	25.412	13	—
	3/4	25.400	1	12.700	1/2	10.1	13.4	21.8	6 500	—	—	B128	M1281	19.037	19.050	25.391	25.412	16	18
	3/4	25.400	1	12.700	1/2	10.1	9.35	13.1	19 000	BT128	MK1281	—	—	19.037	19.050	25.391	25.412	14	16
	3/4	25.400	1	12.700	1/2	—	12.4	22.3	6 500	—	—	Y128	—	19.037	19.050	25.391	25.412	18	—
	3/4	25.400	1	15.880	5/8	13.2	15.6	30.0	6 500	—	—	B1210	M12101	19.037	19.050	25.391	25.412	20	23
	3/4	25.400	1	15.880	5/8	13.2	12.0	18.0	19 000	BT1210	MK12101	—	—	19.037	19.050	25.391	25.412	17	19
	3/4	25.400	1	15.880	5/8	—	15.8	30.6	6 500	—	—	Y1210	—	19.037	19.050	25.391	25.412	22	—
	3/4	25.400	1	19.050	3/4	16.5	18.9	38.4	6 500	—	—	B1212	M12121	19.037	19.050	25.391	25.412	25	28
	3/4	25.400	1	19.050	3/4	16.5	14.4	22.8	19 000	BT1212A	MK12121	—	—	19.037	19.050	25.391	25.412	21	23
	3/4	25.400	1	19.050	3/4	—	20.2	42.0	6 500	—	—	Y1212	—	19.037	19.050	25.391	25.412	26	—

[Notes] 1) FN in bearing number indicates a bearing comprising polyamide molded cage.
 2) The recommended dimensional tolerances of shaft shown above are applicable except h6.
 3) The recommended dimensional tolerances of housing bore shown above are applicable except J7.

[Remark] Limiting speed of grease lubrication should be kept to under 60 % of that for oil lubrication.

Drawn cup needle roller bearings

Inch series

F_w (19.050) ~ (22.225) mm

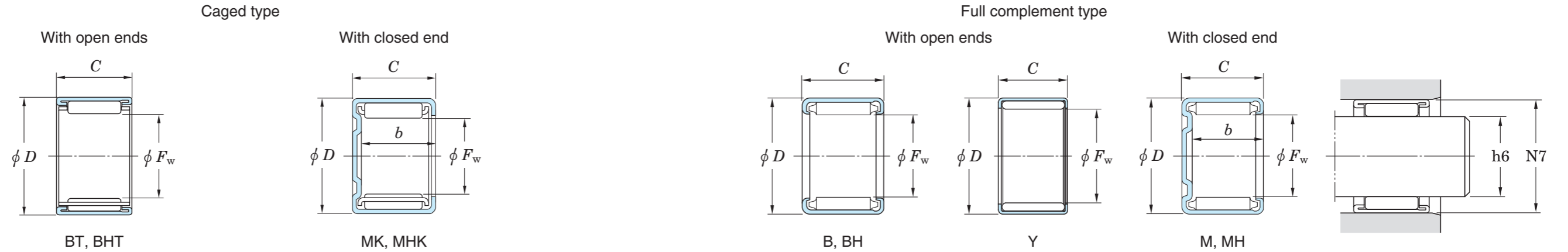

Boundary dimensions							Basic load ratings (kN)		Limiting speeds (min ⁻¹)	Bearing No. ¹⁾		Recommended dimensions (mm)				(Refer.) Mass (g)				
F_w	D	C	b	C_r	C_{0r}	Oil lub.	Caged type		Full complement type		Shaft dia. (h6)		Housing bore dia. (J7)		With open ends	With closed end				
							mm	inch	mm	inch	mm	inch	min.	max.			min.	max.		
19.050	3/4	25.400	1	25.400	1	22.8	18.9	32.3	19 000	BT1216	MK12161	—	—	19.037	19.050	25.391	25.412	28	31	
20.638	13/16	26.988	11/16	9.520	3/8	—	8.70	14.5	6 100	—	—	B136	—	20.625	20.638	26.979	27.000	13	—	
	13/16	26.988	11/16	9.520	3/8	6.8	6.30	8.00	17 000	BT136	MK1361	—	—	20.625	20.638	26.979	27.000	12	13	
	13/16	26.988	11/16	9.520	3/8	—	9.55	16.4	6 100	—	—	Y136	—	20.625	20.638	26.979	27.000	14	—	
	13/16	26.988	11/16	12.700	1/2	10.1	12.7	23.6	6 100	—	—	B138	M1381	20.625	20.638	26.979	27.000	17	19	
	13/16	26.988	11/16	12.700	1/2	—	9.50	13.6	17 000	BT138A	—	—	—	20.625	20.638	26.979	27.000	16	—	
	13/16	26.988	11/16	12.700	1/2	—	13.5	25.5	6 100	—	—	Y138	—	—	20.625	20.638	26.979	27.000	19	—
	13/16	26.988	11/16	19.050	3/4	16.5	15.2	24.9	17 000	BT1312	MK13121	—	—	20.625	20.638	26.979	27.000	22	15	
	13/16	26.988	11/16	22.220	7/8	19.5	23.0	50.8	6 100	—	—	B1314	M13141	20.625	20.638	26.979	27.000	32	36	
	13/16	26.988	11/16	22.220	7/8	19.5	17.5	29.9	17 000	BT1314	MK13141	—	—	20.625	20.638	26.979	27.000	28	31	
	13/16	26.988	11/16	22.220	7/8	—	23.7	52.7	6 100	—	—	Y1314	—	20.625	20.638	26.979	27.000	33	—	
	13/16	26.988	11/16	25.400	1	22.8	26.2	60.0	6 100	—	—	B1316	M13161	20.625	20.638	26.979	27.000	37	42	
	13/16	26.988	11/16	25.400	1	22.8	19.9	35.3	17 000	BT1316	MK13161	—	—	20.625	20.638	26.979	27.000	31	36	
	13/16	26.988	11/16	25.400	1	—	26.8	61.8	6 100	—	—	Y1316	—	20.625	20.638	26.979	27.000	37	—	
13/16	28.575	1 1/8	15.880	5/8	12.9	16.8	28.6	5 900	—	—	BH1310	MH13101	20.625	20.638	28.566	28.587	28	32		
13/16	28.575	1 1/8	19.050	3/4	16.0	21.4	38.8	5 900	—	—	BH1312	MH13121	20.625	20.638	28.566	28.587	34	38		
13/16	28.575	1 1/8	19.050	3/4	16.0	15.6	21.7	17 000	BHT1312	MHK13121	—	—	20.625	20.638	28.566	28.587	28	32		
22.225	7/8	28.575	1 1/8	9.520	3/8	6.8	8.75	15.3	5 700	—	—	B146	M1461	22.212	22.225	28.566	28.587	13	15	
	7/8	28.575	1 1/8	9.520	3/8	—	6.50	8.75	16 000	BT146P	—	—	—	22.212	22.225	28.566	28.587	13	—	
	7/8	28.575	1 1/8	9.520	3/8	—	9.65	17.4	5 700	—	—	Y146	—	22.212	22.225	28.566	28.587	15	—	
	7/8	28.575	1 1/8	12.700	1/2	10.1	12.9	25.1	5 700	—	—	B148	M1481	22.212	22.225	28.566	28.587	19	21	
	7/8	28.575	1 1/8	12.700	1/2	10.1	9.75	14.7	16 000	BT148A	MK1481	—	—	22.212	22.225	28.566	28.587	15	17	
	7/8	28.575	1 1/8	12.700	1/2	—	13.7	27.2	5 700	—	—	Y148	—	22.212	22.225	28.566	28.587	20	—	
	7/8	28.575	1 1/8	19.050	3/4	16.5	20.1	44.6	5 700	—	—	B1412	M14121	22.212	22.225	28.567 ³⁾	28.588 ³⁾	28	32	
	7/8	28.575	1 1/8	19.050	3/4	16.5	15.5	26.5	16 000	BT1412	MK14121	—	—	22.212	22.225	28.566	28.587	26	29	
	7/8	28.575	1 1/8	19.050	3/4	—	21.6	48.8	5 700	—	—	Y1412	—	22.212	22.225	28.566	28.587	31	—	
	7/8	28.575	1 1/8	25.400	1	22.8	26.6	64.0	5 700	—	—	B1416	M14161	22.212	22.225	28.566	28.587	39	44	

[Notes] 1) FN in bearing number indicates a bearing comprising polyamide molded cage.
 2) The recommended dimensional tolerances of shaft shown above are applicable except h6.
 3) The recommended dimensional tolerances of housing bore shown above are applicable except J7.

[Remark] Limiting speed of grease lubrication should be kept to under 60 % of that for oil lubrication.

Drawn cup needle roller bearings

Inch series

F_w (22.225) ~ (25.400) mm

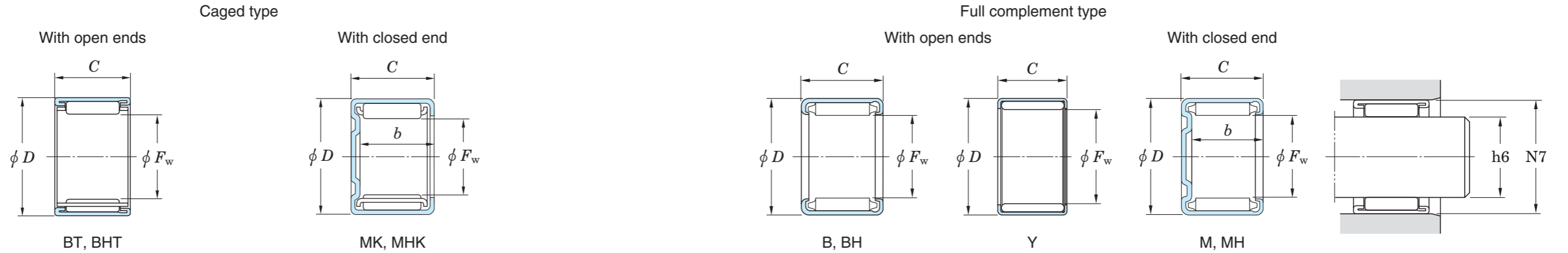

Boundary dimensions							Basic load ratings (kN)		Limiting speeds (min ⁻¹)	Bearing No. ¹⁾				Recommended dimensions (mm)				(Refer.) Mass (g)	
F_w		D		C		b	C_r	C_{0r}	Oil lub.	Caged type		Full complement type		Shaft dia. (h6)		Housing bore dia. (J7)		With open ends	With closed end
mm	inch	mm	inch	mm	inch	min.				With open ends	With closed end	With open ends	With closed end	min.	max.	min.	max.	ends	end
22.225	7/8	28.575	1 1/8	25.400	1	22.8	20.6	38.4	16 000	BT1416A	MK14161	—	—	22.212	22.225	28.566	28.587	35	39
	7/8	28.575	1 1/8	25.400	1	—	27.3	66.1	5 700	—	—	Y1416	—	22.212	22.225	28.566	28.587	40	—
	7/8	30.162	13/16	15.880	5/8	12.7	17.3	30.5	5 500	—	—	BH1410	MH14101	22.212	22.225	30.151	30.176	30	34
	7/8	30.162	13/16	19.050	3/4	16.5	21.4	40.1	5 500	—	—	BH1412	MH14121	22.212	22.225	30.151	30.176	36	41
	7/8	30.162	13/16	19.050	3/4	16.5	16.8	24.7	16 000	BHT1412	MHK14121	—	—	22.212	22.225	30.151	30.176	29	33
	7/8	30.162	13/16	25.400	1	22.8	23.5	37.9	16 000	BHT1416	MHK14161	—	—	22.212	22.225	30.151	30.176	39	44
23.812	15/16	30.162	13/16	15.880	5/8	12.7	13.7	22.7	15 000	BT1510	MK15101	—	—	23.799	23.812	30.151	30.176	22	25
	15/16	30.162	13/16	25.400	1	22.8	28.3	68.8	5 300	—	—	B1516	M15161	23.799	23.812	30.151	30.176	42	47
	15/16	30.162	13/16	25.400	1	22.8	22.3	42.4	15 000	BT1516	MK15161	—	—	23.799	23.812	30.151	30.176	35	40
	15/16	30.162	13/16	25.400	1	—	29.0	71.2	5 300	—	—	Y1516	—	23.799	23.812	30.151	30.176	42	—
25.400	1	31.750	1 1/4	9.520	3/8	—	9.65	17.9	5 000	—	—	B166	—	25.387	25.400	31.739	31.764	15	—
	1	31.750	1 1/4	9.520	3/8	6.8	6.50	9.10	14 000	BT166	MK1661	—	—	25.387	25.400	31.739	31.764	14	16
	1	31.750	1 1/4	11.110	7/16	8.6	11.9	23.5	5 000	—	—	B167	M1671	25.387	25.400	31.739	31.764	18	21
	1	31.750	1 1/4	11.110	7/16	8.8	8.40	7.25	14 000	BT167	MK1671	—	—	25.387	25.400	31.739	31.764	16	19
	1	31.750	1 1/4	11.110	7/16	—	12.7	25.5	5 000	—	—	Y167	—	25.387	25.400	31.739	31.764	20	—
	1	31.750	1 1/4	12.700	1/2	10.1	14.1	29.1	5 000	—	—	B168	M1681	25.387	25.400	31.739	31.764	21	23
	1	31.750	1 1/4	12.700	1/2	10.1	10.5	16.7	14 000	BT168	MK1681	—	—	25.387	25.400	31.739	31.764	19	21
	1	31.750	1 1/4	12.700	1/2	—	14.8	31.1	5 000	—	—	Y168	—	25.387	25.400	31.739	31.764	23	—
	1	31.750	1 1/4	19.050	3/4	16.5	21.9	51.3	5 000	—	—	B1612	M16121-1	25.387	25.400	31.739	31.764	32	37
	1	31.750	1 1/4	19.050	3/4	16.5	16.5	29.8	14 000	BT1612	MK16121	—	—	25.387	25.400	31.739	31.764	29	33
	1	31.750	1 1/4	19.050	3/4	—	23.5	56.2	5 000	—	—	Y1612	—	25.387	25.400	31.739	31.764	34	—
	1	31.750	1 1/4	25.400	1	22.8	28.9	73.4	5 000	—	—	B1616	M16161	25.387	25.400	31.739	31.764	44	50
	1	31.750	1 1/4	25.400	1	22.8	22.0	43.1	14 000	BT1616A	MK16161	—	—	25.387	25.400	31.739	31.764	38	43
	1	31.750	1 1/4	25.400	1	—	30.4	78.3	5 000	—	—	Y1616	—	25.387	25.400	31.739	31.764	45	—
	1	33.338	15/16	12.700	1/2	9.6	13.9	24.0	4 900	—	—	BH168	MH1681	25.387	25.400	33.327	33.352	27	30
	1	33.338	15/16	15.880	5/8	—	18.8	35.2	4 900	—	—	BH1610	—	25.387	25.400	33.327	33.352	34	—
1	33.338	15/16	19.050	3/4	16.0	23.8	47.6	4 900	—	—	BH1612	MH16121	25.387	25.400	33.327	33.352	39	44	
1	33.338	15/16	19.050	3/4	16.0	17.5	26.9	14 000	BHT1612	MHK16121	—	—	25.387	25.400	33.327	33.352	32	36	

[Notes] 1) FN in bearing number indicates a bearing comprising polyamide molded cage.
 2) The recommended dimensional tolerances of shaft shown above are applicable except h6.
 3) The recommended dimensional tolerances of housing bore shown above are applicable except J7.

[Remark] Limiting speed of grease lubrication should be kept to under 60 % of that for oil lubrication.

Drawn cup needle roller bearings

Inch series

F_w (25.400) ~ 30.162 mm

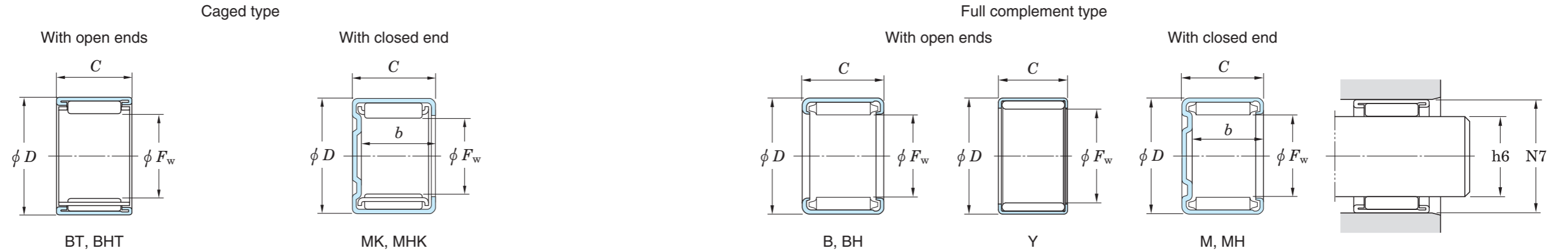

Boundary dimensions							Basic load ratings (kN)		Limiting speeds (min ⁻¹)	Bearing No. ¹⁾		Recommended dimensions (mm)				(Refer.) Mass (g)							
F_w	mm	inch	D	mm	inch	C	mm	inch	b	min.	C_r	C_{Or}	Oil lub.	Caged type		Full complement type		Shaft dia. (h6)		Housing bore dia. (J7)		With open ends	With closed end
														With open ends	With closed end	With open ends	With closed end	min.	max.	min.	max.		
25.400	1	33.338	15/16	25.400	1	22.3	32.0	69.7	4 900	—	—	—	—	BH1616	MH16161	25.387	25.400	33.327	33.352	55	62		
	1	33.338	15/16	25.400	1	22.3	23.5	39.2	14 000	BHT1616	MHK16161	—	—	—	—	25.387	25.400	33.327	33.352	42	48		
	1	33.338	15/16	31.750	1 1/4	—	39.2	90.7	4 900	—	—	—	—	BH1620	—	25.387	25.400	33.327	33.352	67	—		
	1	33.338	15/16	38.100	1 1/2	35.0	46.6	113	4 900	—	—	—	—	BH1624	M16241	25.387	25.400	33.327	33.352	85	96		
26.988	11/16	33.338	15/16	15.880	5/8	13.2	19.0	43.4	4 800	—	—	—	—	B1710	M17101	26.975	26.988	33.327	33.352	28	32		
	11/16	33.338	15/16	15.880	5/8	—	18.6	42.3	4 800	—	—	—	—	Y1710	—	26.975	26.988	33.327	33.352	30	—		
	11/16	33.338	15/16	25.400	1	—	30.2	78.8	4 800	—	—	—	—	B1716	—	26.975	26.988	33.327	33.352	47	—		
28.575	1 1/8	34.925	1 3/8	9.520	3/8	6.8	10.3	20.1	4 500	—	—	—	—	B186	M1861	28.562	28.575	34.914	34.939	17	19		
	1 1/8	34.925	1 3/8	12.700	1/2	10.1	14.7	31.8	4 500	—	—	—	—	B188-1	M1881	28.562	28.575	34.914	34.939	22	25		
	1 1/8	34.925	1 3/8	12.700	1/2	10.1	11.9	20.3	13 000	BT188	MK1881	—	—	—	—	28.562	28.575	34.914	34.939	21	24		
	1 1/8	34.925	1 3/8	19.050	3/4	16.5	23.3	57.6	4 500	—	—	—	—	B1812	M18121	28.562	28.575	34.914	34.939	36	41		
	1 1/8	34.925	1 3/8	19.050	3/4	16.5	18.6	36.0	13 000	BT1812-1	MK18121	—	—	—	—	28.562	28.575	34.914	34.939	26	30		
	1 1/8	34.925	1 3/8	19.050	3/4	—	25.3	64.1	4 500	—	—	—	—	Y1812MU	—	28.562	28.575	34.914	34.939	38	—		
	1 1/8	34.925	1 3/8	25.400	1	22.8	30.9	82.6	4 500	—	—	—	—	B1816A	M18161	28.562	28.575	34.914	34.939	49	56		
	1 1/8	38.100	1 1/2	19.050	3/4	15.4	26.2	48.6	4 300	—	—	—	—	BH1812	MH18121	28.562	28.575	38.089	38.114	55	62		
	1 1/8	38.100	1 1/2	19.050	3/4	15.4	20.8	30.3	12 000	BHT1812	MHK18121	—	—	—	—	28.562	28.575	38.089	38.114	42	47		
	1 1/8	38.100	1 1/2	25.400	1	21.8	36.1	73.6	4 300	—	—	—	—	BH1816	MH18161	28.562	28.575	38.089	38.114	73	82		
	1 1/8	38.100	1 1/2	25.400	1	21.8	27.9	44.3	12 000	BHT1816	MHK18161	—	—	—	—	28.562	28.575	38.089	38.114	55	63		
	1 1/8	38.100	1 1/2	28.580	1 1/8	25.8	31.9	52.5	12 000	BHT1818	MHK18181	—	—	—	—	28.562	28.575	38.089	38.114	62	70		
1 1/8	38.100	1 1/2	31.750	1 1/4	28.1	45.3	98.4	4 300	—	—	—	—	BH1820	MH18201	28.562	28.575	38.089	38.114	91	103			
30.162	13/16	38.100	1 1/2	15.880	5/8	12.4	21.2	42.4	4 200	—	—	—	—	B1910	M19101	30.146	30.162	38.089	38.114	38	42		
	13/16	38.100	1 1/2	15.880	5/8	12.4	17.5	27.7	12 000	BT1910	MK19101	—	—	—	—	30.146	30.162	38.089	38.114	33	37		
	13/16	38.100	1 1/2	15.880	5/8	—	22.7	46.5	4 200	—	—	—	—	Y1910	—	30.146	30.162	38.089	38.114	42	—		
	13/16	38.100	1 1/2	19.050	3/4	—	26.2	55.7	4 200	—	—	—	—	B1912	—	30.146	30.162	38.089	38.114	46	—		
	13/16	38.100	1 1/2	19.050	3/4	—	29.4	64.7	4 200	—	—	—	—	Y1912AM	—	30.146	30.162	38.089	38.114	50	—		
	13/16	38.100	1 1/2	25.400	1	—	35.3	81.7	4 200	—	—	—	—	B1916	—	30.146	30.162	38.089	38.114	63	—		
	13/16	38.100	1 1/2	25.400	1	21.8	28.4	51.9	12 000	BT1916M	MK19161	—	—	—	—	30.146	30.162	38.089	38.114	54	61		

[Notes] 1) FN in bearing number indicates a bearing comprising polyamide molded cage.
 2) The recommended dimensional tolerances of shaft shown above are applicable except h6.
 3) The recommended dimensional tolerances of housing bore shown above are applicable except J7.

[Remark] Limiting speed of grease lubrication should be kept to under 60 % of that for oil lubrication.

Drawn cup needle roller bearings

Inch series

F_w 31.750 ~ (34.925) mm

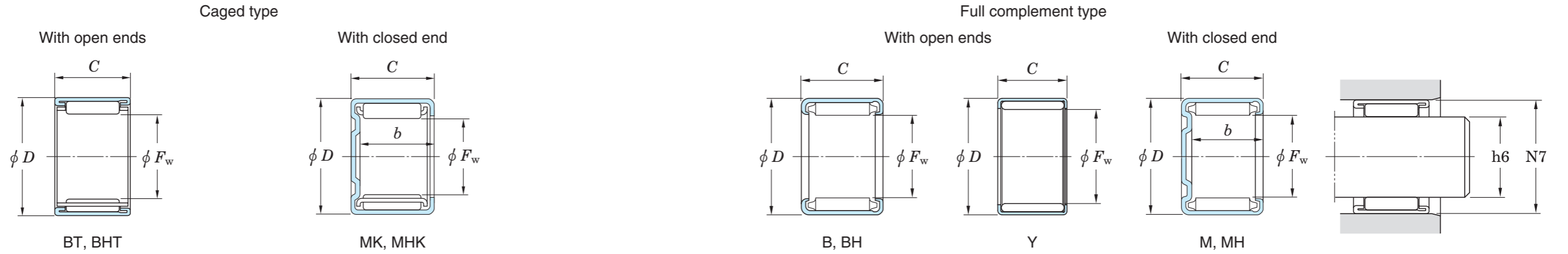

Boundary dimensions							Basic load ratings (kN)		Limiting speeds (min ⁻¹)	Bearing No. ¹⁾				Recommended dimensions (mm)				(Refer.) Mass (g)	
F_w	D		C		b min.	C_r	C_{0r}	Oil lub.	Caged type		Full complement type		Shaft dia. (h6)		Housing bore dia. (J7)		With open ends	With closed end	
	mm	inch	mm	inch					mm	inch	mm	inch	With open ends	With closed end	min.	max.			min.
31.750	1 1/4	38.100	1 1/2	12.700	1/2	10.1	15.9	36.4	4 100	—	—	B208	M2081	31.734	31.750	38.089	38.114	25	28
	1 1/4	38.100	1 1/2	12.700	1/2	10.1	7.80	11.5	12 000	BT208A	MK2081	—	—	31.734	31.750	38.089	38.114	22	25
	1 1/4	38.100	1 1/2	15.880	5/8	13.2	20.3	50.0	4 100	—	—	B2010	M20101	31.734	31.750	38.089	38.114	33	37
	1 1/4	38.100	1 1/2	15.880	5/8	—	20.9	51.8	4 100	—	—	Y2010	—	31.734	31.750	38.089	38.114	34	—
	1 1/4	38.100	1 1/2	19.050	3/4	16.5	24.1	38.0	4 100	—	—	B2012	M20121	31.734	31.750	38.089	38.114	40	45
	1 1/4	38.100	1 1/2	19.050	3/4	16.5	19.4	39.0	12 000	BT2012	MK20121	—	—	31.734	31.750	38.089	38.114	35	40
	1 1/4	38.100	1 1/2	19.050	3/4	—	26.4	70.2	4 100	—	—	Y2012	—	31.734	31.750	38.089	38.114	41	—
	1 1/4	38.100	1 1/2	25.400	1	—	32.3	90.9	4 100	—	—	B2016	—	31.734	31.750	38.089	38.114	54	—
	1 1/4	38.100	1 1/2	25.400	1	22.8	25.4	55.4	12 000	BT2016	MK20161	—	—	31.734	31.750	38.089	38.114	47	53
	1 1/4	38.100	1 1/2	25.400	1	—	34.7	99.4	4 100	—	—	Y2016	—	31.734	31.750	38.089	38.114	56	—
	1 1/4	38.100	1 1/2	31.750	1 1/4	29.2	39.8	119	4 100	—	—	B2020	M20201	31.734	31.750	38.089	38.114	68	77
	1 1/4	38.100	1 1/2	31.750	1 1/4	—	40.5	121	4 100	—	—	Y2020	—	31.734	31.750	38.089	38.114	9	—
	1 1/4	41.275	1 5/8	19.050	3/4	15.4	28.3	54.7	3 900	—	—	BH2012	MH20121	31.734	31.750	41.264	41.289	57	64
	1 1/4	41.275	1 5/8	25.400	1	21.8	39.0	82.5	3 900	—	—	BH2016	MH20161	31.734	31.750	41.264	41.289	80	91
1 1/4	41.275	1 5/8	25.400	1	21.8	29.8	48.8	11 000	BHT2016	MHK20161	—	—	31.734	31.750	41.264	41.289	69	78	
1 1/4	41.275	1 5/8	31.750	1 1/4	28.1	48.9	110	3 900	—	—	BH2020	MH20201	31.734	31.750	41.264	41.289	100	113	
33.338	15/16	41.275	1 5/8	12.700	1/2	9.1	16.8	33.6	3 900	—	—	B218	M2181	33.322	33.338	41.264	41.289	34	39
	15/16	41.275	1 5/8	12.700	1/2	—	17.2	34.5	3 900	—	—	Y218	—	33.322	33.338	41.264	41.289	37	—
	15/16	41.275	1 5/8	15.880	5/8	12.4	22.3	48.3	3 900	—	—	B2110	M21101	33.322	33.338	41.264	41.289	42	47
	15/16	41.275	1 5/8	15.880	5/8	—	22.6	49.2	3 900	—	—	Y2110	—	33.322	33.338	41.264	41.289	46	—
34.925	1 3/8	41.275	1 5/8	12.700	1/2	10.1	16.1	39.0	3 800	—	—	B228	M2281	34.909	34.925	41.264	41.289	27	31
	1 3/8	41.275	1 5/8	12.700	1/2	10.1	12.8	24.3	11 000	BT228	MK2281	—	—	34.909	34.925	41.264	41.289	24	27
	1 3/8	41.275	1 5/8	12.700	1/2	—	16.7	41.1	3 800	—	—	Y228	—	34.909	34.925	41.264	41.289	30	—
	1 3/8	41.275	1 5/8	19.050	3/4	16.5	25.4	70.1	3 800	—	—	B2212	M22121	34.909	34.925	41.264	41.289	44	49
	1 3/8	41.275	1 5/8	19.050	3/4	16.5	19.5	41.9	11 000	BT2212	MK22121	—	—	34.909	34.925	41.264	41.289	36	41
	1 3/8	41.275	1 5/8	19.050	3/4	—	25.9	72.2	3 800	—	—	Y2212	—	34.909	34.925	41.264	41.289	50	—
	1 3/8	41.275	1 5/8	25.400	1	—	33.6	101	3 800	—	—	B2216	—	34.909	34.925	41.264	41.289	59	—

[Notes] 1) FN in bearing number indicates a bearing comprising polyamide molded cage.
 2) The recommended dimensional tolerances of shaft shown above are applicable except h6.
 3) The recommended dimensional tolerances of housing bore shown above are applicable except J7.

[Remark] Limiting speed of grease lubrication should be kept to under 60 % of that for oil lubrication.

Drawn cup needle roller bearings

Inch series

F_w (34.925) ~ 41.275 mm

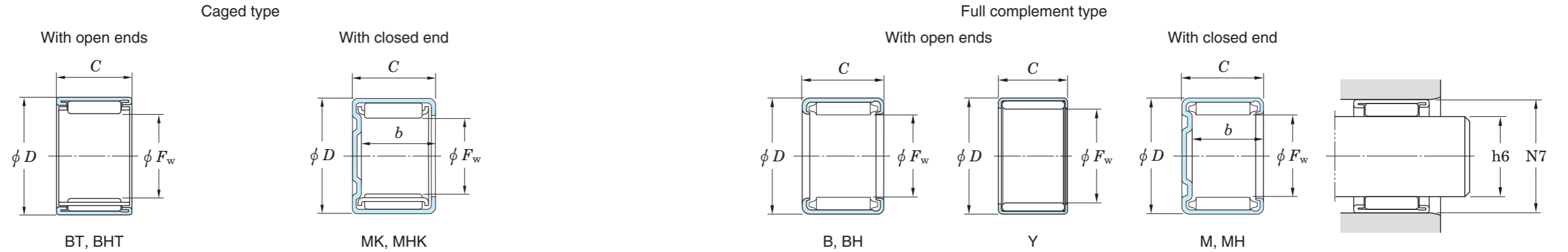

Boundary dimensions							Basic load ratings (kN)		Limiting speeds (min ⁻¹)	Bearing No. ¹⁾				Recommended dimensions (mm)				(Refer.) Mass (g)	
F_w		D		C		b	C_r	C_{0r}	Oil lub.	Caged type		Full complement type		Shaft dia. (h6)		Housing bore dia. (J7)		With open ends	With closed end
mm	inch	mm	inch	mm	inch	min.				With open ends	With closed end	With open ends	With closed end	min.	max.	min.	max.	ends	end
34.925	1 3/8	41.275	1 5/8	31.750	1 1/4	29.2	41.3	131	3 800	—	—	B2220	M22201	34.909	34.925	41.264	41.289	75	85
	1 3/8	41.275	1 5/8	31.750	1 1/4	—	41.8	133	3 800	—	—	Y2220	—	34.909	34.925	41.264	41.289	75	—
	1 3/8	44.450	1 3/4	12.700	1/2	—	11.6	14.9	10 000	BHT228E	—	—	—	34.912 ²⁾	34.925 ²⁾	44.417 ³⁾	44.442 ³⁾	38	—
	1 3/8	44.450	1 3/4	19.050	3/4	15.4	23.4	37.2	10 000	BHT2212	MHK22121	—	—	34.909	34.925	44.439	44.464	56	64
	1 3/8	44.450	1 3/4	25.400	1	21.8	31.4	54.3	10 000	BHT2216	MHK22161	—	—	34.909	34.925	44.439	44.464	75	85
38.100	1 1/2	47.625	1 7/8	12.700	1/2	9.3	17.5	31.8	3 300	—	—	B248	M2481	38.084	38.100	47.614	47.639	47	53
	1 1/2	47.625	1 7/8	12.700	1/2	—	23.3	45.7	3 300	—	—	Y248	—	38.084	38.100	47.614	47.639	47	—
	1 1/2	47.625	1 7/8	15.880	5/8	12.4	24.3	48.3	3 300	—	—	B2410	M24101	38.084	38.100	47.614	47.639	54	61
	1 1/2	47.625	1 7/8	15.880	5/8	—	26.6	54.2	3 300	—	—	Y2410	—	38.084	38.100	47.614	47.639	63	—
	1 1/2	47.625	1 7/8	19.050	3/4	—	30.6	64.9	3 300	—	—	B2412	—	38.084	38.100	47.614	47.639	67	—
	1 1/2	47.625	1 7/8	19.050	3/4	15.4	24.6	41.0	9 600	BT2412	MK24121	—	—	38.084	38.100	47.614	47.639	61	69
	1 1/2	47.625	1 7/8	22.220	7/8	18.7	36.5	81.5	3 300	—	—	B2414	M24141	38.084	38.100	47.614	47.639	80	91
	1 1/2	47.625	1 7/8	22.220	7/8	—	38.6	87.6	3 300	—	—	Y2414	—	38.084	38.100	47.614	47.639	88	—
	1 1/2	47.625	1 7/8	25.400	1	21.8	42.2	98.3	3 300	—	—	B2416	M24161	38.084	38.100	47.614	47.639	94	106
	1 1/2	47.625	1 7/8	25.400	1	21.8	33.1	59.9	9 600	BT2416	MK24161	—	—	38.084	38.100	47.614	47.639	81	92
	1 1/2	47.625	1 7/8	25.400	1	—	44.1	104	3 300	—	—	Y2416	—	38.084	38.100	47.614	47.639	101	—
	1 1/2	47.625	1 7/8	31.750	1 1/4	28.1	53.0	132	3 300	—	—	B2420	M24201	38.084	38.100	47.614	47.639	120	135
	1 1/2	47.625	1 7/8	31.750	1 1/4	28.1	43.7	85.9	9 600	BT2420	MK24201	—	—	38.084	38.100	47.614	47.639	105	119
1 1/2	47.625	1 7/8	31.750	1 1/4	—	54.9	138	3 300	—	—	Y2420	—	38.084	38.100	47.614	47.639	126	—	
41.275	1 5/8	50.800	2	12.700	1/2	—	17.9	33.6	3 100	—	—	B268	—	41.259	41.275	50.788	50.818	51	—
	1 5/8	50.800	2	12.700	1/2	—	20.9	41.0	3 100	—	—	Y268	—	41.259	41.275	50.788	50.818	54	—
	1 5/8	50.800	2	15.880	5/8	12.4	25.1	51.8	3 100	—	—	B2610	M26101	41.259	41.275	50.788	50.818	58	66
	1 5/8	50.800	2	15.880	5/8	12.4	21.0	34.5	8 900	BT2610	MK26101	—	—	41.259	41.275	50.788	50.818	54	61
	1 5/8	50.800	2	15.880	5/8	—	27.6	58.7	3 100	—	—	Y2610	—	41.259	41.275	50.788	50.818	68	—
	1 5/8	50.800	—	22.220	7/8	17.2	28.7	29.8	8 900	BT2614	—	—	—	41.259	41.275	50.788	50.818	78	—
	1 5/8	50.800	2	31.750	1 1/4	31.7	55.1	142	3 100	—	—	B2620	M26201	41.259	41.275	50.788	50.818	129	146
	1 5/8	50.800	2	31.750	1 1/4	28.1	44.1	89.6	8 900	BT2620	MK26201	—	—	41.259	41.275	50.788	50.818	109	123

[Notes] 1) FN in bearing number indicates a bearing comprising polyamide molded cage.
 2) The recommended dimensional tolerances of shaft shown above are applicable except h6.
 3) The recommended dimensional tolerances of housing bore shown above are applicable except J7.

[Remark] Limiting speed of grease lubrication should be kept to under 60 % of that for oil lubrication.

Drawn cup needle roller bearings

Inch series

F_w 44.450 ~ 52.388 mm

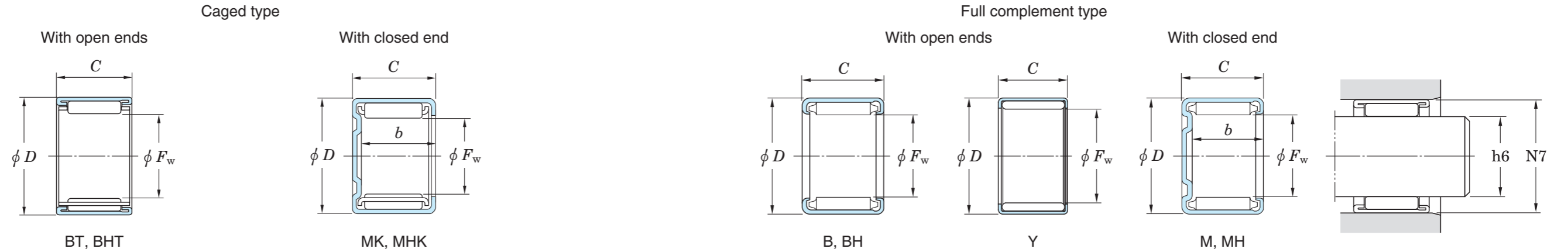

Boundary dimensions							Basic load ratings (kN)		Limiting speeds (min ⁻¹)	Bearing No. ¹⁾				Recommended dimensions (mm)				(Refer.) Mass (g)	
F_w	D	C	b	C_r	C_{0r}	Oil lub.	Caged type		Full complement type		Shaft dia. (h6)		Housing bore dia. (J7)		With open ends	With closed end			
							mm	inch	mm	inch	mm	inch	min.	mm			max.	min.	max.
44.450	1 3/4	53.975	2 1/8	19.050	3/4	15.7	32.7	75.1	2 900	—	—	44.434	44.450	53.963	53.993	78	88		
	1 3/4	53.975	2 1/8	19.050	3/4	15.7	26.8	48.6	8 300	BT2812	MK28121	44.434	44.450	53.963	53.993	70	79		
	1 3/4	53.975	2 1/8	25.400	1	21.8	47.1	120	2 900	—	—	44.434	44.450	53.963	53.993	110	125		
	1 3/4	53.975	2 1/8	25.400	1	—	36.6	72.6	8 300	BT2816	—	44.434	44.450	53.963	53.993	93	—		
	1 3/4	53.975	2 1/8	25.400	1	—	47.1	120	2 900	—	—	44.434	44.450	53.963	53.993	116	—		
	1 3/4	53.975	2 1/8	38.100	1 1/2	34.5	67.8	192	2 900	—	—	44.434	44.450	53.963	53.993	169	191		
	1 3/4	53.975	2 1/8	38.100	1 1/2	34.5	54.0	120	8 300	BT2824	MK28241	44.434	44.450	53.963	53.993	140	158		
47.625	1 7/8	57.150	2 1/4	12.700	1/2	9.1	19.6	39.4	2 700	—	—	47.609	47.625	57.138	57.168	58	65		
	1 7/8	57.150	2 1/4	12.700	1/2	9.1	17.3	27.8	7 800	BT308	MK3081	47.609	47.625	57.138	57.168	50	56		
	1 7/8	57.150	2 1/4	12.700	1/2	—	22.4	46.8	2 700	—	—	47.609	47.625	57.138	57.168	62	—		
	1 7/8	57.150	2 1/4	15.880	5/8	11.0	23.0	40.1	7 800	BT3010-1	—	47.609	47.625	57.138	57.168	64	—		
	1 7/8	57.150	2 1/4	25.400	1	21.8	47.7	124	2 700	—	—	47.609	47.625	57.138	57.168	114	129		
	1 7/8	57.150	2 1/4	25.400	1	21.8	37.5	75.5	7 800	BT3016	MK30161	47.609	47.625	57.138	57.168	99	112		
50.800	2	60.325	2 3/8	12.700	1/2	9.1	19.9	41.3	2 600	—	—	50.781	50.800	60.313	60.343	61	69		
	2	60.325	2 3/8	12.700	1/2	—	23.2	50.4	2 600	—	—	50.781	50.800	60.313	60.343	66	—		
	2	60.325	2 3/8	25.400	1	21.8	48.5	130	2 600	—	—	50.781	50.800	60.313	60.343	121	137		
	2	60.325	2 3/8	25.400	1	21.8	37.7	78.1	7 300	BT3216	MK32161	50.781	50.800	60.313	60.343	105	119		
	2	60.325	2 3/8	25.400	1	—	51.1	139	2 600	—	—	50.781	50.800	60.313	60.343	131	—		
	2	60.325	2 3/8	31.750	1 1/4	28.1	61.0	175	2 600	—	—	50.781	50.800	60.313	60.343	152	172		
	2	60.325	2 3/8	38.100	1 1/2	—	72.7	219	2 600	—	—	50.781	50.800	60.313	60.343	183	—		
	2	60.325	2 3/8	44.450	1 3/4	40.8	84.0	264	2 600	—	—	50.781	50.800	60.313	60.343	223	252		
52.388	2 1/16	64.294	2 17/32	25.400	1	21.8	57.2	131	2 400	—	—	52.369	52.388	64.282	64.312	160	181		
	2 1/16	64.294	2 17/32	25.400	1	—	48.7	89.2	7 000	BHT3316	—	52.372 ²⁾	52.388 ²⁾	64.280 ³⁾	64.305 ³⁾	138	—		
	2 1/16	64.294	2 17/32	38.100	1 1/2	34.5	86.3	223	2 400	—	—	52.369	52.388	64.282	64.312	240	271		

[Notes] 1) FN in bearing number indicates a bearing comprising polyamide molded cage.
 2) The recommended dimensional tolerances of shaft shown above are applicable except h6.
 3) The recommended dimensional tolerances of housing bore shown above are applicable except J7.

[Remark] Limiting speed of grease lubrication should be kept to under 60 % of that for oil lubrication.



Machined ring needle roller bearings

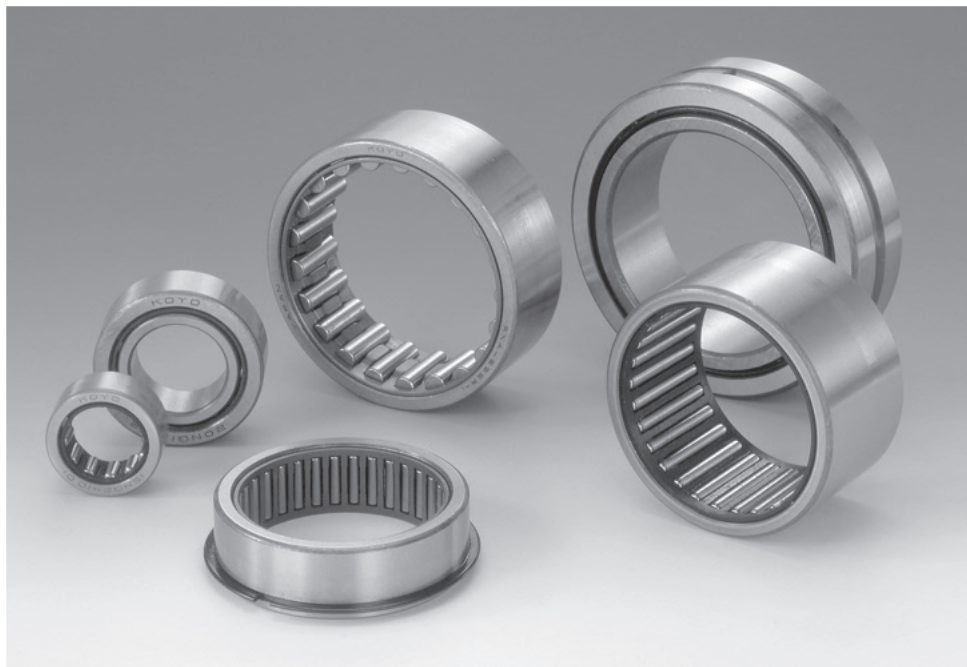

NEEDLE
ROLLER
BEARINGS

Machined ring needle roller bearings

The Koyo machined ring needle roller bearings are provided with cages. The inner rings, outer rings and rollers, made of high carbon chromium bearing steel, are precisely machined and after heat treatment, are finished by grinding.

- It can withstand heavy load and impact load.
- Permit installation in split housings.

1 Bearing number

(Ex. 1)

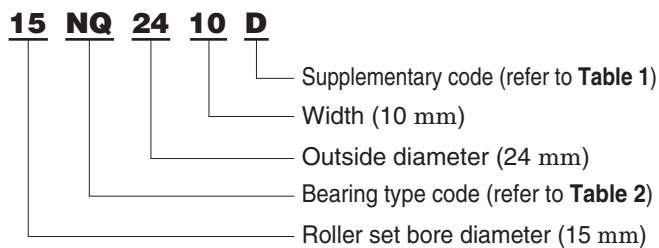

(Ex. 3) Applicable to NA (or RNA) 49, 59 and 69.

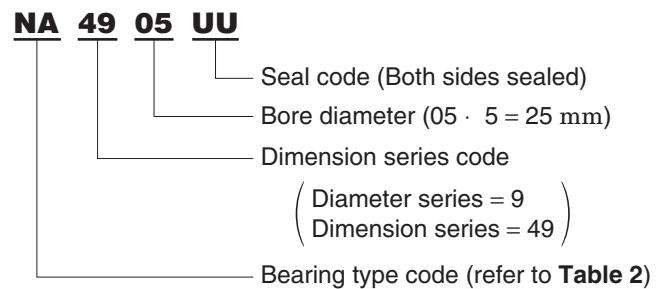

(Ex. 2)

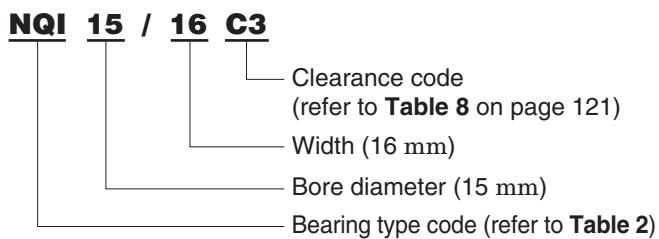

Table 1 Supplementary code (Applicable to NQ, NQS, NQI and NQIS.)

Code	Description
D	Using case carburizing steel for outer rings
W	With lubrication holes and lubrication groove (outer ring)
W10	With anti-rotation pin hole (outer ring)
W11	With lubrication holes and anti-rotation pin hole (outer ring)
N	With snap ring groove (outer ring)
NR	With locating snap ring (outer ring)

Table 2 Type code of machined ring needle roller bearings

Type	Without inner ring			With inner ring			
Type code	RNA49 RNA59	NQ NQS	RNA69	NA49 NA59	NQI NQIS	NA49...UU	NA69

2 Shaft and Housing

The machined ring needle roller bearing is usually mounted on the hardened shaft without using an inner ring.

It is therefore necessary to satisfy the specifications in **Table 3** when designing the shaft and housing.

Table 3 Specifications of shafts and housings

	Shaft		Housing bore (Fitting surface)
	Raceway surface	Fitting surface	
Roundness	Best if less than one half or one third of the shaft diameter (housing bore diameter) tolerance.		
Cylindricity	5 μm or less per 25 mm, or one half or less of the shaft diameter (housing bore diameter) tolerance.		
Roughness (Ra)	0.4 <i>a</i> or less	0.8 <i>a</i> or less	1.6 <i>a</i> or less
Hardness¹⁾	58 HRC or harder (60 to 64 HRC are best.)	—	—
Shaft Slope	13 μm or less per 25 mm		

[Note] 1) Case hardened steel which is carburized or induction-hardened should not only meet the surface hardness requirement specified above but also have a case depth of 52.3 HRC (550 HV) to a depth in the range (0.08 to 0.1) × *D_w* mm. (*D_w* : roller diameter)
In general, 30 thru 45 HRC is best for the center hardness.

3 Tolerances

The dimensional and running accuracy of Koyo machined ring needle roller bearing are as specified in JIS B 1536-1.

Variation of minimum roller set/roller complement bore diameter, *F_{ws min}* (class F6) is described in **Table 4**; radial bearing tolerance is described in **Table 5**.

Table 4 Machined ring needle roller bearings variation of minimum roller set/roller complement bore diameter *F_{ws min}*¹⁾ (for interchangeable bearings²⁾ and bearings without inner ring)

Unit : μm

Nominal roller set/roller complement bore diameter <i>F_w</i> (mm)		<i>F_{ws min}</i> tolerance (F6)	
over	up to	upper	lower
6	10	+22	+13
10	18	+27	+16
18	30	+33	+20
30	50	+41	+25
50	80	+49	+30
80	120	+58	+36
120	180	+68	+43
180	250	+79	+50

[Notes] 1) The minimum single roller set bore diameter of roller complement is the diameter of a cylinder whose radial internal clearance disappears completely, at least in one radial direction.

2) A group of bearings with inner rings that have the same bearing number. Outer ring, cage and needle roller assemblies and inner rings are interchangeable among them.

Table 5 Radial bearing tolerances = JIS B 1536 =
(1-1) Inner ring

Unit : μm

Nominal bore diameter d mm		Single plane mean bore diameter deviation Δ_{dmp}								Single plane bore diameter variation V_{dsp} Diameter series 9				Mean bore diameter variation V_{dmp}			
		class 0		class 6		class 5		class 4		class 0	class 6	class 5	class 4	class 0	class 6	class 5	class 4
		upper	lower	upper	lower	upper	lower	upper	lower	max.				max.			
2.5	10	0	-8	0	-7	0	-5	0	-4	10	9	5	4	6	5	3	2
10	18	0	-8	0	-7	0	-5	0	-4	10	9	5	4	6	5	3	2
18	30	0	-10	0	-8	0	-6	0	-5	13	10	6	5	8	6	3	2.5
30	50	0	-12	0	-10	0	-8	0	-6	15	13	8	6	9	8	4	3
50	80	0	-15	0	-12	0	-9	0	-7	19	15	9	7	11	9	5	3.5
80	120	0	-20	0	-15	0	-10	0	-8	25	19	10	8	15	11	5	4
120	150	0	-25	0	-18	0	-13	0	-10	31	23	13	10	19	14	7	5
150	180	0	-25	0	-18	0	-13	0	-10	31	23	13	10	19	14	7	5
180	250	0	-30	0	-22	0	-15	0	-12	38	28	15	12	23	17	8	6

[Remark] Values in Italics are prescribed in JTEKT standards.

(1-2) Inner ring

Unit : μm

Nominal bore diameter d mm		Radial runout of assembled bearing inner ring K_{ia}				Perpendicularity of inner ring face with respect to the bore S_d		Single inner ring width deviation Δ_{Bs}								Inner ring width variation V_{Bs}				
		class 0	class 6	class 5	class 4	class 5	class 4	class 0		class 6		class 5		class 4		class 0	class 6	class 5	class 4	class 2
		upper	lower	upper	lower	upper	lower	upper	lower	upper	lower	upper	lower	upper	lower	max.				
2.5	10	10	6	4	2.5	7	3	0	-120	0	-120	0	-40	0	-40	15	15	5	2.5	1.5
10	18	10	7	4	2.5	7	3	0	-120	0	-120	0	-80	0	-80	20	20	5	2.5	1.5
18	30	13	8	4	3	8	4	0	-120	0	-120	0	-120	0	-120	20	20	5	2.5	1.5
30	50	15	10	5	4	8	4	0	-120	0	-120	0	-120	0	-120	20	20	5	3	1.5
50	80	20	10	5	4	8	5	0	-150	0	-150	0	-150	0	-150	25	25	6	4	1.5
80	120	25	13	6	5	9	5	0	-200	0	-200	0	-200	0	-200	25	25	7	4	2.5
120	150	30	18	8	6	10	6	0	-250	0	-250	0	-250	0	-250	30	30	8	5	2.5
150	180	30	18	8	6	10	6	0	-250	0	-250	0	-250	0	-250	30	30	8	5	4
180	250	40	20	10	8	11	7	0	-300	0	-300	0	-300	0	-300	30	30	10	6	5

[Remark] Values in Italics are prescribed in JTEKT standards.

Table 5 Radial bearing tolerances = JIS B 1536 =
(2-1) Outer ring

Unit : μm

Nominal outside dia. <i>D</i> mm		Single plane mean outside diameter deviation								Single plane outside diameter variation V_{Dsp}				Mean outside diameter variation V_{Dmp}			
		Δ_{Dmp}								Diameter series 9							
		class 0		class 6		class 5		class 4		class 0 ¹⁾	class 6 ¹⁾	class 5	class 4	class 0 ¹⁾	class 6 ¹⁾	class 5	class 4
over	up to	upper	lower	upper	lower	upper	lower	upper	lower	max.				max.			
6	18	0	-8	0	-7	0	-5	0	-4	10	9	5	4	6	5	3	2
18	30	0	-9	0	-8	0	-6	0	-5	12	10	6	5	7	6	3	2.5
30	50	0	-11	0	-9	0	-7	0	-6	14	11	7	6	8	7	4	3
50	80	0	-13	0	-11	0	-9	0	-7	16	14	9	7	10	8	5	3.5
80	120	0	-15	0	-13	0	-10	0	-8	19	16	10	8	11	10	5	4
120	150	0	-18	0	-15	0	-11	0	-9	23	19	11	9	14	11	6	5
150	180	0	-25	0	-18	0	-13	0	-10	31	23	13	10	19	14	7	5
180	250	0	-30	0	-20	0	-15	0	-11	38	25	15	11	23	15	8	6
250	315	0	-35	0	-25	0	-18	0	-13	44	31	18	13	26	19	9	7

[Note] 1) Shall be applied when locating snap ring is not fitted.

[Remark] Values in Italics are prescribed in JTEKT standards.

(2-2) Outer ring

Unit : μm

Nominal outside dia. <i>D</i> mm		Radial runout of assembled bearing outer ring				Perpendicularity of outer ring outside surface with respect to the face		Deviation of a single outer ring width		Ring width variation			
		K_{ea}				S_D		Δ_{Cs}		V_{Cs}			
		class 0	class 6	class 5	class 4	class 5	class 4	class 0, 6, 5, 4	class 0	class 6	class 5	class 4	
over	up to	max.				max.		upper	lower	max.			
6	18	15	8	5	3	8	4	Shall conform to the tolerance Δ_{Bs} on <i>d</i> of the same bearing	Shall conform to the tolerance V_{Bs} on <i>d</i> of the same bearing	5	2.5	5	2.5
18	30	15	9	6	4	8	4			5	2.5		
30	50	20	10	7	5	8	4			5	2.5		
50	80	25	13	8	5	8	4			6	3		
80	120	35	18	10	6	9	5			8	4		
120	150	40	20	11	7	10	5			8	5		
150	180	45	23	13	8	10	5			8	5		
180	250	50	25	15	10	11	7			10	7		
250	315	60	30	18	11	13	8	11	7				

[Note] 1) Shall be applied when locating snap ring is not fitted.

[Remark] Values in Italics are prescribed in JTEKT standards.

4 Fits

When mounting the bearing onto the shaft or housing, the fit must be determined by taking into account the operating conditions, such as load magnitude and types, material the parts fitted, dimensions and shapes, size and type of the bearing, temperature, and running accuracy.

Generally, in the case of an inner ring rotating load, the fit for the inner ring must be interference fit in order to prevent creep, while the fit for outer ring may be clearance fit.

In the case of an outer ring rotating load, the conditions

must be the opposite those of an inner ring rotating load. In the case of an indeterminate direction load, a interference fit is usual for both inner and outer rings, although there are some exceptions.

Fits between the inner ring and the shaft and between the outer ring and the housing are shown in **Table 6** and **Table 7**.

(Tolerances for the shaft and housing are shown on pages 196 to 199)

Table 6 Recommended fits of inner ring and shaft

Operating condition		Shaft diameter (mm)	Class of shaft tolerance range	Applications (for reference)
Stationary inner ring load	Inner ring needs to move smoothly on shaft.	All shaft diameters	g 6	Stationary shaft wheels, tension pulleys, rope sheaves etc.
	Inner ring does not need to move smoothly on shaft.		h 6	
	High accuracy or noiseless rotation is required.		h 5	
Rotating inner ring load	Light load	40 mm or less	js 6	Electric appliances, machine tools, pumps, blowers, carriers etc.
	Normal load	40 mm or less	k 5	Electric motors, turbines, internal combustion engines, wood-working machines etc.
		over 40 mm or less	m 5	
		over 100 mm	m 6	
	Heavy load or impact load	140 mm or less	n 6	Railway rolling stock axle journals, traction motors
over 140 mm		p 6		

Table 7 Recommended fits of the outer ring and housing

Operating condition		Class of housing bore tolerance range	Applications (for reference)
Rotating outer ring load	Heavy load with shock	P 7	Fly wheels
	Normal load	N 7	Loose wheels, crank shaft, gears
	Light fluctuating load	M 7	Rope pulley, jockey puller
Extreme impact load	Eccentric pump wheel		
Indeterminate direction load	Normal load	K 7	Compressor
	Light load	J 7	Compressor, crank shaft
Stationary outer ring load	Split housing, normal load	H 7	General use
	High accuracy and rigidity are required	K 6	Machine tool spindle

[Notes] 1) This table is applicable to cast iron or steel housing. For light alloy housings, somewhat more interference fits than shown are recommended.
 2) Interference fits larger than J7 should not be used in split housings.

5 Clearance

When a machined ring needle roller bearing is used, the selection of clearance before mounting must take into account the change of clearance after mounting and the variation during operation. This is important in order to maintain the correct operating clearance resulting into the most of bearing performance and life. (For details, refer to page 20)

The radial internal clearances before mounting are shown in **Table 8**. They are classified into 5 groups according to size -- C2, standard clearance (no mark), C3, C4 and C5.

The roller set/roller complement bore diameter of Koyo machined ring needle roller bearings is of F6 class. If there is no inner ring, the relation between the radial internal clearance and the shaft used is as shown in **Table 9**.

Table 9 Relation between radial internal clearance and tolerance class of a shaft

Roller set/roller complement bore diameter (mm)	C 2	Standard	C 3	C 4
Over 3 up to 180	k 5	h 5	f 6	e 6

Table 8 Radial internal clearances of machined ring needle roller bearings
 Unit : μm

Nominal bore diameter d , mm		Clearance									
		C 2		C N		C 3		C 4		C 5	
over	up to	min.	max.	min.	max.	min.	max.	min.	max.	min.	max.
—	10	0	25	20	45	35	60	50	75	—	—
10	24	0	25	20	45	35	60	50	75	65	90
24	30	0	25	20	45	35	60	50	75	70	95
30	40	5	30	25	50	45	70	60	85	80	105
40	50	5	35	30	60	50	80	70	100	95	125
50	65	10	40	40	70	60	90	80	110	110	140
65	80	10	45	40	75	65	100	90	125	130	165
80	100	15	50	50	85	75	110	105	140	155	190
100	120	15	55	50	90	85	125	125	165	180	220
120	140	15	60	60	105	100	145	145	190	200	245
140	160	20	70	70	120	115	165	165	215	225	275
160	180	25	75	75	125	120	170	170	220	250	300
180	200	35	90	90	145	140	195	195	250	275	330
200	225	45	105	105	165	160	220	220	280	305	365
225	250	45	110	110	175	170	235	235	300	330	395

Machined ring needle roller bearings

F_w 12 ~ 17 mm

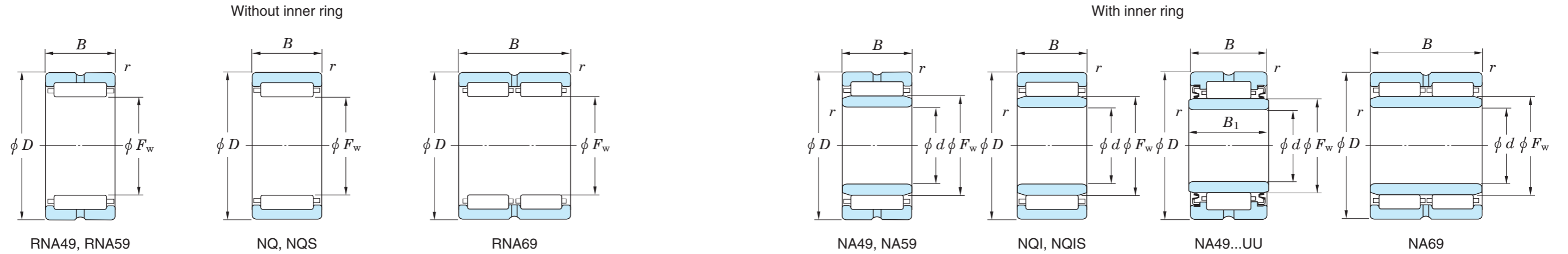

F_w	Boundary dimensions (mm)					Basic load ratings (kN)		Limiting speeds ¹⁾ (min ⁻¹) Oil lub.	Bearing No.		Mounting dimensions (mm)			(Refer.) Mass (kg)		(Refer.) Applicable inner ring No.	
	d	D	B	B_1	$r_{min.}$	C_r	C_{0r}		Without inner ring	With inner ring	d_a min.	D_a max.	r_a max.	Without inner ring	With inner ring		
12	—	19	10	—	0.3	5.9	6.3	35 000	NQ12/10 12NQ2410A	—	17	0.3	0.010	—			
	—	24	9.8	—	0.3	5.9	6.3			—	22	0.3			0.023	—	
14	10	22	13	14	0.3	7.5	7.7	14 000	— RNA4900 RNA4900R NQ14/16D	NA4900UU NA4900 NA4900R	12	20	0.3	—	0.025	IRM101414 IRM101413 IRM101413	
	10	22	13	—	0.3	7.6	9.1	31 000			12	20	0.3	0.017	0.025		
	10	22	13	—	0.3	9.3	10.1	30 000			12	20	0.3	0.016	0.023		
	—	22	16	—	0.5	11.7	13.7	30 000			—	19	0.5	0.021	—		
15	—	23	12	—	0.3	8.8	9.7	29 000	NQ15/12 15NQ2410D NQ152512 NQS15/16 15NQ2815	—	—	21	0.3	0.017	—	—	
	—	24	10	—	0.3	8.5	8.2	28 000			—	22	0.3	0.016	—		
	—	25	12	—	0.6	10.5	10.8	28 000			—	21	0.6	0.022	—		
	—	26	16	—	0.3	13.4	14.8	28 000			—	24	0.3	0.034	—		
	—	28	15	—	1	7.9	9.8	28 000			—	23	1	0.043	—		
16	—	23	16	—	0.5	13.1	16.4	27 000	16NQ2316 NQ15/16B 16NQ2322A NQ16/12 — RNA4901 RNA4901R NQ16/16D — NQ16/20 RNA6901	— — — — NA4901UU NA4901 NA4901R — NQI12/16D — NA6901	—	20	0.5	0.018	—	—	
	—	23	16	—	0.5	15.2	17.4	28 000			—	20	0.5	0.020	—		
	—	23	22	—	0.5	17.1	23.0	27 000			—	20	0.5	0.025	—		
	—	24	12	—	0.3	7.7	9.6	28 000			—	22	0.3	0.019	—		
	12	24	13	14	0.3	8.3	9.2	12 000			14	22	0.3	—	0.028		IRM121614
	12	24	13	—	0.3	8.6	11.1	28 000			14	22	0.3	0.019	0.028		IRM121613
	12	24	13	—	0.3	10.2	11.8	27 000			14	22	0.3	0.018	0.027		IRM121613
	—	24	16	—	0.3	10.9	15.2	28 000			—	22	0.3	0.025	—		—
	12	24	16	16	0.3	10.9	15.2	28 000			14	22	0.3	—	0.036		—
	—	24	20	—	0.3	13.1	19.1	28 000			—	22	0.3	0.032	—		—
12	24	22	—	0.3	16.3	21.7	27 000	14	22	0.3	0.030	0.045	IRM121622				
17	—	25	16	—	0.5	11.3	16.2	26 000	NQ17/16D 17NQ2520 17NQ3013D 17NQ3216D	—	—	22	0.5	0.026	—	—	
	—	25	20	—	0.3	13.7	20.6	26 000			—	23	0.3	0.033	—		
	—	30	13	—	0.3	10.0	10.5	25 000			—	28	0.3	0.041	—		
	—	32	16	—	0.6	18.0	16.5	23 000			—	28	0.6	0.053	—		

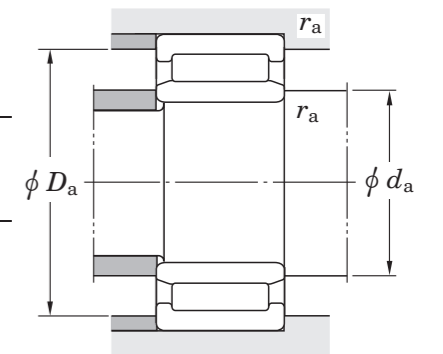

[Note] 1) Limiting speeds of bearing number NA49...UU indicates the value of sealed and grease lubricated bearings.
[Remark] Limiting speed of grease lubrication should be kept to unber 60 % of that for oil lubrication.

Machined ring needle roller bearings

F_w 18 ~ (22) mm

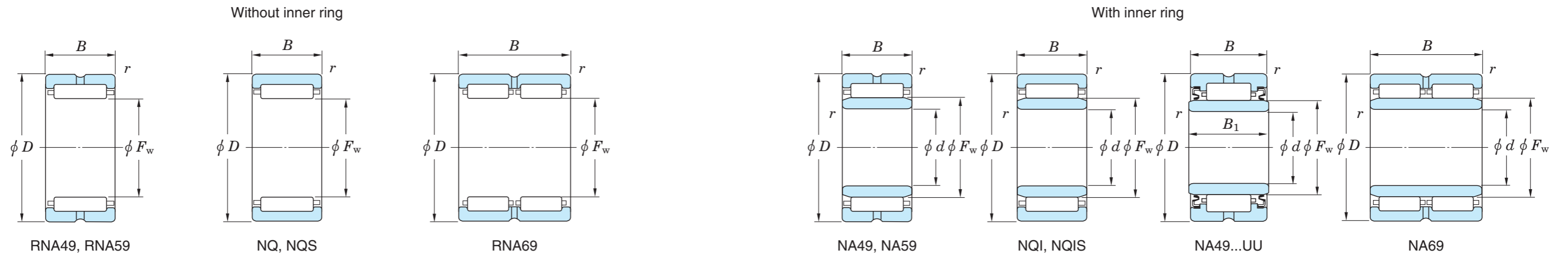

F_w	Boundary dimensions (mm)					Basic load ratings (kN)		Limiting speeds ¹⁾ (min ⁻¹)	Bearing No.		Mounting dimensions (mm)			(Refer.) Mass (kg)		(Refer.) Applicable inner ring No.
	d	D	B	B_1	$r_{min.}$	C_r	C_{0r}	Oil lub.	Without inner ring	With inner ring	d_a min.	D_a max.	r_a max.	Without inner ring	With inner ring	
18	—	25	16	—	0.3	11.7	17.2	25 000	18NQ2516	—	—	23	0.3	0.023	—	—
	—	26	13	—	0.3	11.0	13.6	24 000	RNA49/14R	—	—	24	0.3	0.020	—	—
	—	26	16	—	0.3	11.7	17.2	25 000	NQ18/16	—	—	24	0.3	0.027	—	—
	—	26	20	—	0.3	14.1	21.7	25 000	NQ18/20	—	—	24	0.3	0.035	—	—
	—	28	19	—	0.3	16.9	20.9	24 000	18NQ2819	—	—	26	0.3	0.042	—	—
	12	30	16	—	0.3	13.7	14.3	23 000	NQS18/16	NQIS12/16	14	28	0.3	0.044	0.057	—
19	15	27	16	—	0.3	12.1	18.2	24 000	—	NQI15/16	17	25	0.3	0.042	—	—
20	—	27	17	—	0.3	14.7	20.4	22 000	20NQ2717	—	—	25	0.3	0.024	—	—
	15	28	13	14	0.3	9.2	11.1	10 000	—	NA4902UU	17	26	0.3	—	0.037	IRM152014
	15	28	13	—	0.3	9.2	12.8	23 000	RNA4902	NA4902	17	26	0.3	0.023	0.036	IRM152013
	15	28	13	—	0.3	11.3	14.6	22 000	RNA4902R	NA4902R	17	26	0.3	0.021	0.035	IRM152013
	—	28	16	—	0.3	12.0	18.2	23 000	NQ20/16D	—	—	26	0.3	0.030	—	—
	15	28	18	—	0.3	14.7	20.4	22 000	RNA5902	NA5902	17	26	0.3	0.029	0.048	IRM152018
	—	28	20	—	0.3	14.4	23.0	23 000	NQ20/20	—	—	26	0.3	0.038	—	—
	—	28	23	—	0.3	18.4	27.1	22 000	NQ202823	—	—	26	0.3	0.040	—	—
	—	30	20	—	0.3	19.8	26.4	22 000	20NQ3020	—	—	28	0.3	0.048	—	—
	—	32	12	—	0.3	11.9	11.3	21 000	20NQ3212	—	—	30	0.3	0.033	—	—
	—	32	18	—	0.3	21.0	26.1	21 000	NQ203218	—	—	30	0.3	0.053	—	—
	—	33	15	—	0.6	14.0	16.9	21 000	20NQ3315D	—	—	29	0.6	0.052	—	—
	—	34	18	—	0.6	21.1	20.8	20 000	20NQ3418D	—	—	30	0.6	0.060	—	—
21	—	38	17	—	0.6	21.1	21.1	19 000	21NQ3817	—	—	34	0.6	0.082	—	—
22	17	30	13	14	0.3	9.4	11.8	9 100	—	NA4903UU	19	28	0.3	—	0.040	IRM172214
	17	30	13	—	0.3	9.6	14.0	21 000	RNA4903D	NA4903	19	28	0.3	0.025	0.040	IRM172213
	17	30	13	—	0.3	12.1	16.4	20 000	RNA4903R	NA4903R	19	28	0.3	0.023	0.038	IRM172213
	—	30	16	—	0.3	12.7	20.2	21 000	NQ22/16	—	—	28	0.3	0.032	—	—
	17	30	18	—	0.3	15.2	21.9	20 000	RNA5903	NA5903	19	28	0.3	0.031	0.052	IRM172218
	—	30	20	—	0.3	15.3	25.6	21 000	NQ22/20	—	—	28	0.3	0.040	—	—

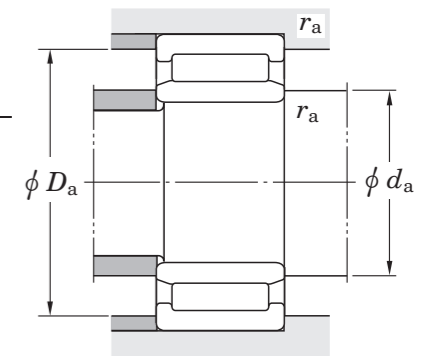

[Note] 1) Limiting speeds of bearing number NA49...UU indicates the value of sealed and grease lubricated bearings.
 [Remark] Limiting speed of grease lubrication should be kept to unber 60 % of that for oil lubrication.

Machined ring needle roller bearings

F_w (22) ~ 28 mm

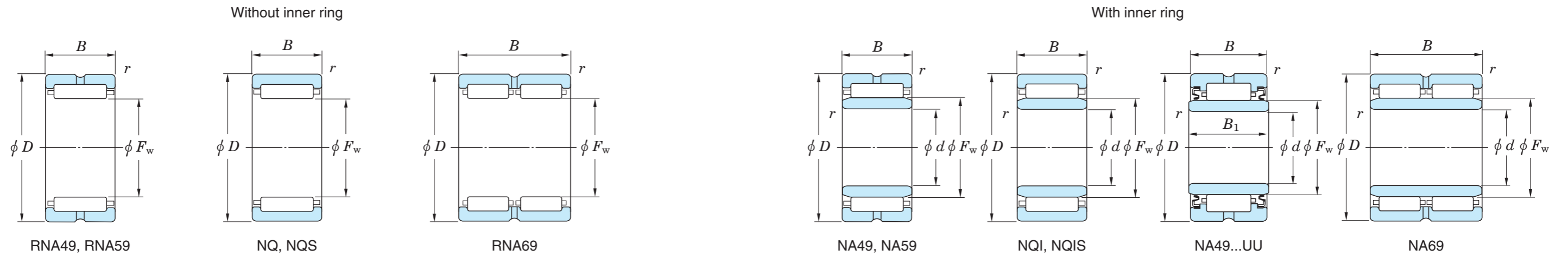

F_w	Boundary dimensions (mm)					Basic load ratings (kN)		Limiting speeds ¹⁾ (min ⁻¹) Oil lub.	Bearing No.		Mounting dimensions (mm)			(Refer.) Mass (kg)		(Refer.) Applicable inner ring No.	
	d	D	B	B_1	$r_{min.}$	C_r	C_{0r}		Without inner ring	With inner ring	d_a min.	D_a max.	r_a max.	Without inner ring	With inner ring		
22	17	30	23	—	0.3	18.9	29.0	20 000	RNA6903	NA6903	19	28	0.3	0.040	0.067	IRM172223	
	—	32	25	—	0.3	22.4	31.7	20 000	22NQ3225	—	—	30	0.3	0.063	—		
24	20	32	12	—	0.3	9.6	14.4	19 000	NQ24/12	NQI20/12	22	30	0.3	0.025	0.038	—	
	20	32	16	—	0.3	13.4	22.2	19 000	NQ24/16	NQI20/16	22	30	0.3	0.035	0.052		
	—	32	20	—	0.3	17.3	26.5	19 000	NQ24/20AD	—	—	30	0.3	0.040	—		
	20	32	20	20	0.3	17.3	26.5	19 000	—	NQI203220AD	22	30	0.3	—	0.062		20IRM2420AD
25	—	33	16	—	0.3	14.1	20.6	18 000	NQ25/16	—	—	31	0.3	0.034	—	—	
	—	33	20	—	0.3	18.9	30.0	18 000	NQ25/20	—	—	31	0.3	0.043	—		
	20	37	14	—	0.3	17.1	19.1	17 000	—	20NQI3714	22	35	0.3	—	0.066		
	—	37	17	—	1	19.3	22.5	17 000	25NQ3717AD-1	—	—	32	1	0.056	—		
	20	37	17	18	0.3	16.4	18.2	8 000	—	NA4904UU	22	35	0.3	—	0.078		IRM202518
	20	37	17	—	0.3	15.9	21.1	18 000	RNA4904	NA4904	22	35	0.3	0.058	0.081		IRM202517
	—	37	17	—	0.9	21.5	25.7	17 000	RNA4904ARD-1	—	—	32	0.9	0.054	—		
	20	37	23	—	0.3	28.0	36.1	17 000	RNA5904	NA5904	22	35	0.3	0.073	0.104		IRM202523
20	37	30	—	0.3	35.4	48.9	17 000	RNA6904	NA6904	22	35	0.3	0.096	0.137	IRM202530		
26	22	34	16	—	0.3	14.1	24.2	18 000	NQ26/16	NQI22/16	24	32	0.3	0.037	0.056	—	
	—	34	20	—	0.3	14.2	28.9	18 000	26NQ3420	—	—	32	0.3	0.042	—		
	—	47	17	—	0.6	21.4	23.6	16 000	26NQ4717	—	—	43	0.6	0.113	—		
	—	52	14	—	0.6	18.0	18.9	16 000	26NQ5214	—	—	48	0.6	0.136	—		
28	—	37	20	—	0.3	20.6	34.7	16 000	NQ283720D	—	—	35	0.3	0.056	—	—	
	—	37	30	—	0.3	29.1	54.1	16 000	NQ28/30	—	—	35	0.3	0.083	—		
	22	39	17	—	0.3	17.8	25.4	16 000	RNA49/22	NA49/22	24	37	0.3	0.056	0.086		IRM222817
	—	39	17	—	0.3	21.8	29.8	16 000	RNA49/22R	—	—	37	0.3	0.055	—		
	22	39	30	—	0.3	36.8	53.1	16 000	RNA69/22	NA69/22	24	37	0.3	0.100	0.154		IRM222830
	—	40	17	—	0.3	15.1	27.4	16 000	28NQ4017	—	—	38	0.3	0.068	—		
	—	40	20	—	0.3	20.6	34.7	16 000	28NQ4020	—	—	38	0.3	0.087	—		

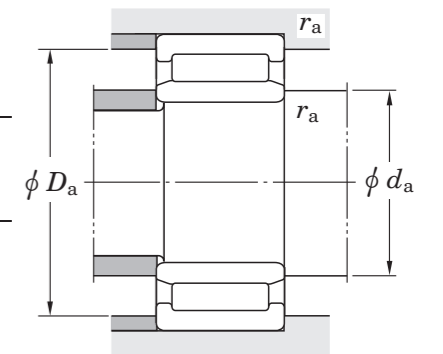

[Note] 1) Limiting speeds of bearing number NA49...UU indicates the value of sealed and grease lubricated bearings.
 [Remark] Limiting speed of grease lubrication should be kept to unber 60 % of that for oil lubrication.

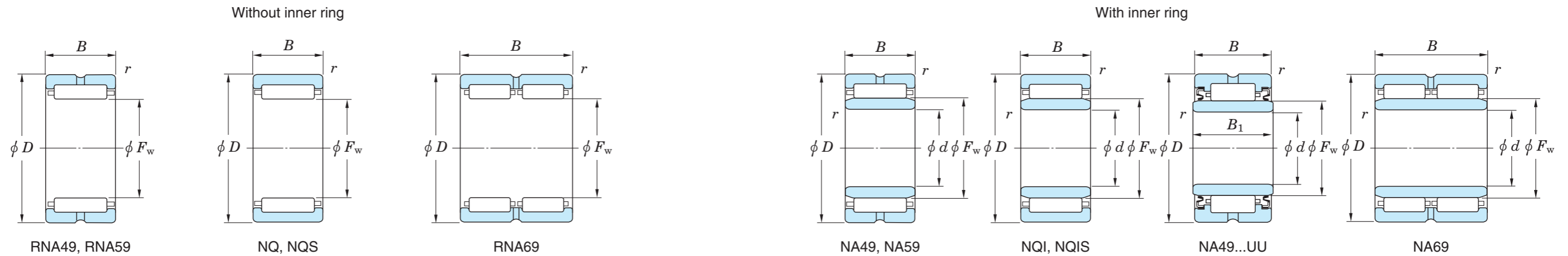

F_w	Boundary dimensions (mm)					Basic load ratings (kN)		Limiting speeds ¹⁾ (min ⁻¹) Oil lub.	Bearing No.		Mounting dimensions (mm)			(Refer.) Mass (kg)		(Refer.) Applicable inner ring No.
	d	D	B	B_1	$r_{min.}$	C_r	C_{0r}		Without inner ring	With inner ring	d_a min.	D_a max.	r_a max.	Without inner ring	With inner ring	
29	—	38	15	—	0.6	14.6	22.6	16 000	—	NQI25/15	29	34	0.6	—	0.061	—
	—	38	20	—	0.6	20.4	34.8	16 000	NQ29/20	—	—	34	0.6	0.056	—	—
	25	38	30	—	0.3	28.9	54.3	16 000	NQ29/30	NQI25/30	27	36	0.3	0.085	0.125	—
30	—	40	20	—	0.3	23.7	37.5	15 000	NQ30/20	—	—	38	0.3	0.066	—	—
	—	40	30	—	0.3	33.5	58.5	15 000	NQ30/30	—	—	38	0.3	0.099	—	—
	25	42	17	18	0.3	18.4	22.4	6 600	—	NA4905UU	27	40	0.3	—	0.092	IRM253018
	25	42	17	—	0.3	18.6	27.4	15 000	RNA4905	NA4905	27	40	0.3	0.065	0.096	IRM253017
	25	42	17	—	0.3	24.2	31.7	15 000	RNA4905R	NA4905R	27	40	0.3	0.065	0.092	IRM253017
	25	42	23	—	0.3	31.7	44.9	15 000	RNA5905	NA5905	27	40	0.3	0.085	0.124	IRM253023
	—	42	30	—	0.6	40.1	60.7	15 000	NQ304230	—	—	38	0.6	0.116	—	—
	25	42	30	—	0.3	40.1	60.7	15 000	RNA6905	NA6905	27	40	0.3	0.112	0.162	IRM253030
25	44	25	25.5	0.3	36.0	48.8	14 000	—	25NQI4425A	27	42	0.3	—	0.161	—	
32	28	42	20	—	0.3	24.3	39.4	14 000	NQ32/20	NQI28/20	30	40	0.3	0.070	0.098	—
	28	42	30	—	0.3	34.4	61.6	14 000	NQ32/30	NQI28/30	30	40	0.3	0.104	0.141	—
	28	45	17	—	0.3	25.0	33.8	14 000	RNA49/28R	NA49/28R	30	43	0.3	0.075	0.099	IRM283217
	25	47	22	—	0.3	31.2	41.4	14 000	NQS32/22	NQIS25/22	27	45	0.3	0.123	0.167	—
35	—	45	14	—	0.6	16.9	29.0	13 000	NQ354514	—	—	41	0.6	0.055	—	—
	30	45	20	—	0.3	24.7	41.4	13 000	—	NQI30/20	32	43	0.3	—	0.108	—
	30	47	17	18	0.3	19.5	25.3	5 700	—	NA4906UU	32	45	0.3	—	0.105	IRM303518
	30	47	17	17	0.3	20.0	31.6	13 000	RNA4906D	NA4906D	32	45	0.3	0.081	0.114	IRM303517D
	30	47	17	—	0.3	26.4	34.4	13 000	RNA4906R	NA4906R	32	45	0.3	0.070	0.103	IRM303517
	30	47	23	—	0.3	33.8	51.0	13 000	RNA5906	NA5906	32	45	0.3	0.096	0.141	IRM303523
	—	47	30	—	0.3	42.7	69.0	13 000	RNA6906	—	—	45	0.3	0.131	—	—
—	48	24	—	0.3	33.9	51.3	13 000	35NQ4824D	—	—	46	0.3	0.123	—	—	
37	32	47	20	—	0.3	26.0	45.1	13 000	NQ37/20	NQI32/20	34	45	0.3	0.079	0.114	—
	—	47	20	—	0.3	26.0	45.1	13 000	NQ37/20D	—	—	45	0.3	0.079	—	—

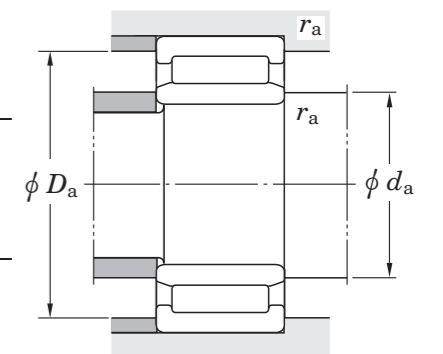

[Note] 1) Limiting speeds of bearing number NA49...UU indicates the value of sealed and grease lubricated bearings.

[Remark] Limiting speed of grease lubrication should be kept to unber 60 % of that for oil lubrication.

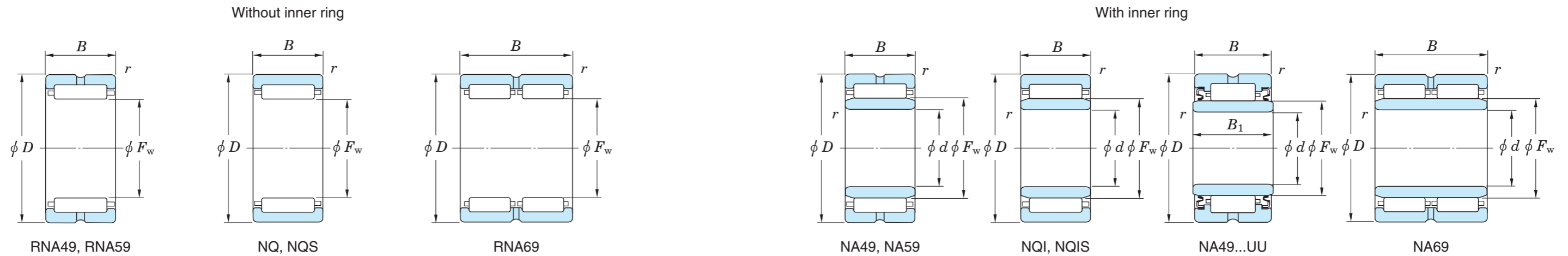

F_w	Boundary dimensions (mm)					Basic load ratings (kN)		Limiting speeds ¹⁾ (min ⁻¹)	Bearing No.		Mounting dimensions (mm)			(Refer.) Mass (kg)		(Refer.) Applicable inner ring No.
	d	D	B	B_1	$r_{min.}$	C_r	C_{0r}		Without inner ring	With inner ring	d_a min.	D_a max.	r_a max.	Without inner ring	With inner ring	
38	—	47	20	—	0.3	23.6	45.8	12 000	38NQ4720	—	—	45	0.3	0.073	—	—
	—	52	35	—	1	49.3	84.7	12 000	38NQ5235	—	—	47	1	0.203	—	—
40	—	48	20	—	0.3	20.9	39.8	12 000	NQ404820	—	—	46	0.3	0.064	—	—
	—	50	15	—	0.3	21.0	35.1	12 000	NQ40/15AD	—	—	48	0.3	0.063	—	—
	35	50	20	—	0.3	27.2	48.8	12 000	NQ40/20	NQI35/20	37	48	0.3	0.085	0.129	—
	35	50	30	—	0.3	39.8	79.8	12 000	NQ40/30	NQI35/30	37	48	0.3	0.120	0.192	—
	—	52	20	—	0.6	31.9	49.3	11 000	RNA49/32R-1	—	—	48	0.6	0.098	—	—
	—	52	30	—	0.6	47.0	81.0	11 000	40NQ5230	—	—	48	0.6	0.148	—	—
42	—	52	20	—	0.6	28.6	53.3	11 000	NQ425220D	—	—	48	0.6	0.087	—	—
	35	55	20	21	0.6	29.0	40.9	4 700	—	NA4907UU	39	51	0.6	—	0.173	IRM354221
	35	55	20	—	0.6	26.9	49.0	11 000	RNA4907	NA4907	39	51	0.6	0.122	0.186	IRM354220
	35	55	20	—	0.6	35.1	52.2	11 000	RNA4907R	NA4907R	39	51	0.6	0.104	0.168	IRM354220
	35	55	27	—	0.6	42.9	67.6	11 000	RNA5907	NA5907	39	51	0.6	0.138	0.225	IRM354227
	35	55	36	—	0.6	51.4	85.1	11 000	RNA6907	NA6907	39	51	0.6	0.182	0.297	IRM354236
43	38	53	30	30	0.6	41.3	85.9	10 000	—	NQI38/30	—	51	0.6	—	0.205	—
45	—	55	20	—	0.6	27.9	52.7	10 000	NQ45/20	—	—	51	0.6	0.100	—	—
	40	55	30	—	0.6	40.9	86.1	10 000	NQ45/30	NQI40/30	44	51	0.6	0.138	0.214	—
	—	58	20	—	0.6	36.0	55.0	10 000	RNA49/38R-1	—	—	54	0.6	0.116	—	—
47	42	57	20	—	0.6	29.0	56.4	10 000	—	NQI42/20	46	53	0.6	—	0.143	—
	42	57	30	—	0.6	44.0	96.1	10 000	—	NQI42/30	46	53	0.6	—	0.219	—
48	40	62	22	23	0.6	35.7	51.7	4 100	—	NA4908UU	44	58	0.6	—	0.235	IRM404823
	40	62	22	—	0.6	32.6	58.5	9 700	RNA4908	NA4908	44	58	0.6	0.157	0.249	IRM404822
	—	62	22	—	0.6	43.2	66.1	9 400	RNA4908R-2	—	—	58	0.6	0.142	—	—
	40	62	30	—	0.6	55.5	91.2	9 400	RNA5908	NA5908	44	58	0.6	0.187	0.313	IRM404830
	40	62	40	—	0.6	66.7	115.0	9 400	RNA6908	NA6908	44	58	0.6	0.256	0.415	IRM404840

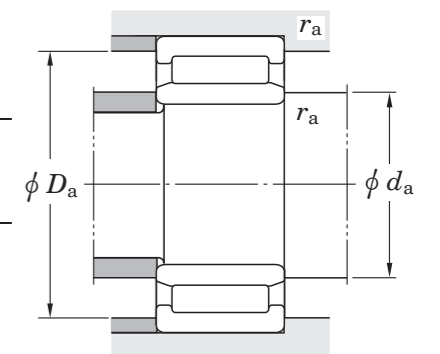

[Note] 1) Limiting speeds of bearing number NA49...UU indicates the value of sealed and grease lubricated bearings.

[Remark] Limiting speed of grease lubrication should be kept to unber 60 % of that for oil lubrication.

Machined ring needle roller bearings

F_w 50 ~ 63 mm

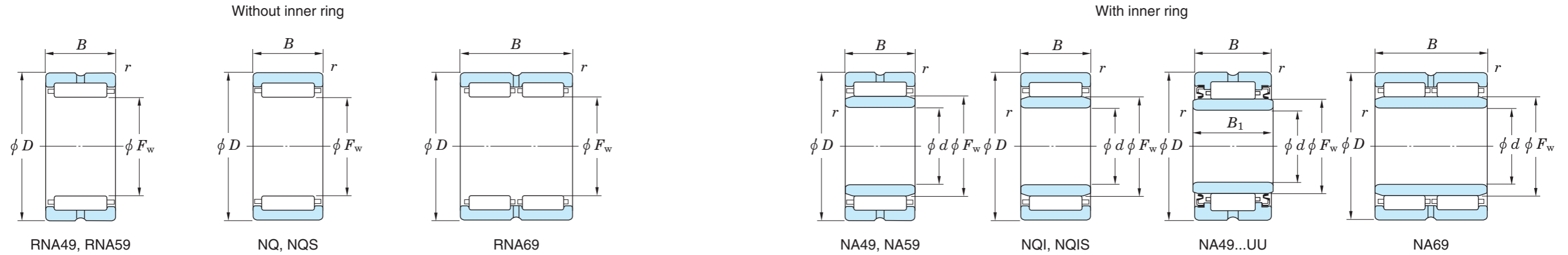

F_w	Boundary dimensions (mm)					Basic load ratings (kN)		Limiting speeds ¹⁾ (min ⁻¹)	Bearing No.		Mounting dimensions (mm)			(Refer.) Mass (kg)		(Refer.) Applicable inner ring No.
	d	D	B	B_1	$r_{min.}$	C_r	C_{0r}	Oil lub.	Without inner ring	With inner ring	d_a min.	D_a max.	r_a max.	Without inner ring	With inner ring	
50	—	62	20	—	0.6	24.8	46.0	9 400	NQ50/20A	—	—	58	0.6	0.126	—	—
	45	62	25	—	0.6	41.9	82.5	9 300	—	NQI45/25	49	58	0.6	—	0.223	—
	45	62	35	—	0.6	58.2	126.0	9 300	—	NQI45/35	49	58	0.6	—	0.316	—
	—	65	25	—	0.6	48.3	77.8	9 100	NQ506525	—	—	61	0.6	0.190	—	—
52	45	68	22	23	0.6	37.7	56.8	3 800	—	NA4909UU	49	64	0.6	—	0.285	IRM455223
	45	68	22	—	0.6	33.2	61.9	9 000	RNA4909	NA4909	49	64	0.6	0.205	0.294	IRM455222
	45	68	22	—	0.6	45.8	72.9	8 800	RNA4909R	NA4909R	49	64	0.6	0.185	0.274	IRM455222
	45	68	30	—	0.6	58.9	101.0	8 800	RNA5909	NA5909	49	64	0.6	0.252	0.365	IRM455230
	45	68	40	—	0.6	70.7	127.0	8 800	RNA6909	NA6909	49	64	0.6	0.334	0.496	IRM455240
53	—	68	24.5	—	0.6	47.1	81.7	8 700	NQ536825A	—	—	64	0.6	0.207	—	—
55	—	67	20	—	0.6	24.1	46.2	8 600	55NQ6720A	—	—	63	0.6	0.136	—	—
	50	68	25	—	0.6	47.4	90.4	8 500	—	NQI50/25	54	64	0.6	—	0.255	—
	—	70	22	—	0.6	46.9	76.5	8 300	RNA49/48R	—	—	66	0.6	0.174	—	—
	—	72	14	—	0.6	12.5	19.6	8 600	55NQ7214	—	—	68	0.6	0.149	—	—
	45	72	22	—	0.6	44.6	71.6	8 300	NQS55/22	NQIS45/22	49	68	0.6	0.210	0.341	—
58	50	72	22	—	0.6	35.7	70.6	8 100	RNA4910	NA4910	54	68	0.6	0.191	0.298	IRM505822
	50	72	22	—	0.6	48.0	80.0	7 900	RNA4910R	NA4910R	54	68	0.6	0.172	0.276	IRM505822
	50	72	30	—	0.6	61.6	110.0	7 900	RNA5910	NA5910	54	68	0.6	0.221	0.375	IRM505830
	50	72	40	—	0.6	74.0	140.0	7 900	RNA6910	NA6910	54	68	0.6	0.291	0.497	IRM505840
60	—	72	25	—	0.6	45.4	97.3	7 900	NQ60/25	—	—	68	0.6	0.164	—	—
	—	75	22	—	0.6	49.1	83.4	7 700	RNA49/52R	—	—	71	0.6	0.188	—	—
63	55	80	25	—	1	44.4	87.2	7 500	RNA4911	NA4911	60	75	1	0.287	0.428	IRM556325
	55	80	25	—	1	58.4	99.0	7 300	RNA4911R	NA4911R	60	75	1	0.260	0.401	IRM556325
	55	80	34	—	1	75.6	138.0	7 300	RNA5911	NA5911	60	75	1	0.354	0.546	IRM556334
	55	80	45	—	1	86.7	165.0	7 300	RNA6911	NA6911	60	75	1	0.458	0.711	IRM556345

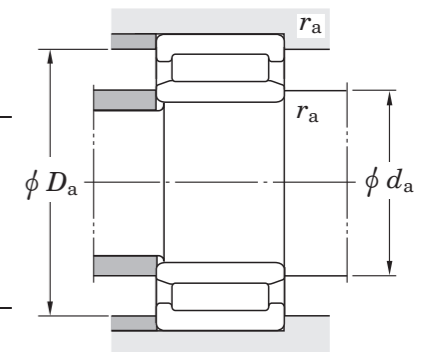

[Note] 1) Limiting speeds of bearing number NA49...UU indicates the value of sealed and grease lubricated bearings.
 [Remark] Limiting speed of grease lubrication should be kept to unber 60 % of that for oil lubrication.

Machined ring needle roller bearings

F_w 65 ~ 105 mm

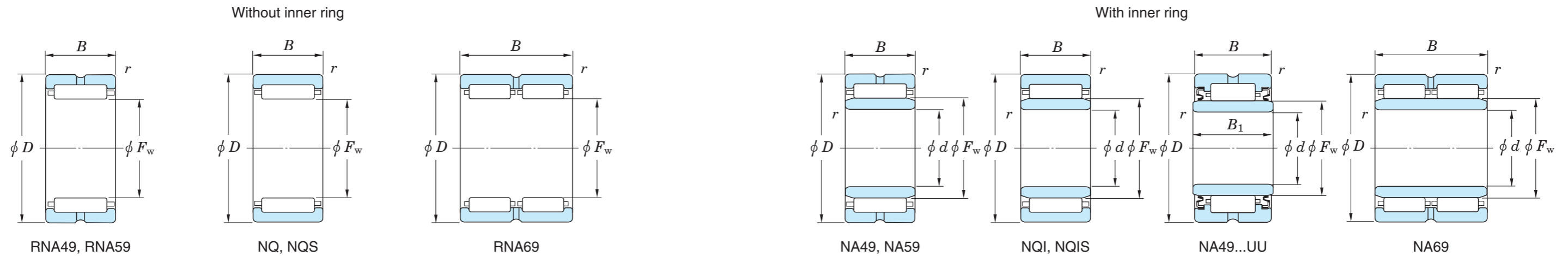

F_w	Boundary dimensions (mm)					Basic load ratings (kN)		Limiting speeds ¹⁾ (min ⁻¹)	Bearing No.		Mounting dimensions (mm)			(Refer.) Mass (kg)		(Refer.) Applicable inner ring No.
	d	D	B	B_1	$r_{min.}$	C_r	C_{0r}	Oil lub.	Without inner ring	With inner ring	d_a min.	D_a max.	r_a max.	Without inner ring	With inner ring	
65	—	82	25	—	1	59.9	103.0	7 100	RNA49/58R	—	—	77	1	0.277	—	—
68	60	85	25	—	1	45.8	93.3	6 900	RNA4912	NA4912	65	80	1	0.310	0.459	IRM606825
	60	85	34	—	1	79.2	150.0	6 800	RNA5912	NA5912	65	80	1	0.380	0.587	IRM606834
70	—	88	25	—	1	64.5	109.0	6 600	RNA49/62	—	—	83	1	0.298	—	—
72	65	90	25	—	1	66.1	114.0	6 400	RNA4913	NA4913	70	85	1	0.307	0.450	IRM657225
	65	90	34	—	1	85.4	158.0	6 400	RNA5913	NA5913	70	85	1	0.419	0.613	IRM657234
	65	90	45	—	1	98.4	190.0	6 400	RNA6913	NA6913	70	85	1	0.541	0.798	IRM657245
75	—	95	30	—	1	82.3	145.0	6 100	RNA49/68	—	—	90	1	0.437	—	—
80	70	100	30	—	1	86.4	157.0	5 700	RNA4914	NA4914	75	95	1	0.483	0.733	IRM708030
	70	100	40	—	1	107.0	207.0	5 700	RNA5914	NA5914	75	95	1	0.615	0.973	IRM708040
	70	100	54	—	1	132.0	271.0	5 700	RNA6914	NA6914	75	95	1	0.895	1.37	IRM708054
85	75	105	30	—	1	88.0	164.0	5 400	RNA4915	NA4915	80	100	1	0.507	0.773	IRM758530
	75	105	40	—	1	109.0	216.0	5 400	RNA5915	NA5915	80	100	1	0.644	1.03	IRM758540
	75	105	54	—	1	135.0	283.0	5 400	RNA6915	NA6915	80	100	1	0.866	1.44	IRM758554
90	80	110	30	—	1	91.6	176.0	5 100	RNA4916	NA4916	85	105	1	0.540	0.819	IRM809030
	80	110	40	—	1	114.0	232.0	5 100	RNA5916	NA5916	85	105	1	0.681	1.09	IRM809040
	80	110	54	—	1	140.0	304.0	5 100	RNA6916	NA6916	85	105	1	0.916	1.46	IRM809054
95	—	115	30	—	1.1	92.8	183.0	4 900	RNA49/82	—	—	108.5	1	0.537	—	—
100	85	120	35	—	1.1	110.0	230.0	4 600	RNA4917	NA4917	91.5	113.5	1	0.669	1.25	IRM8510035
	85	120	46	—	1.1	126.0	293.0	4 700	RNA5917	NA5917	91.5	113.5	1	0.952	1.65	IRM8510046
	85	120	63	—	1.1	165.0	390.0	4 600	RNA6917	NA6917	91.5	113.5	1	1.17	2.29	IRM8510063
105	90	125	35	—	1.1	111.0	238.0	4 400	RNA4918	NA4918	96.5	118.5	1	0.695	1.31	IRM9010535
	90	125	46	—	1.1	137.0	311.0	4 400	RNA5918	NA5918	96.5	118.5	1	0.898	1.70	IRM9010546
	90	125	63	—	1.1	167.0	403.0	4 400	RNA6918	NA6918	96.5	118.5	1	1.21	2.31	IRM9010563

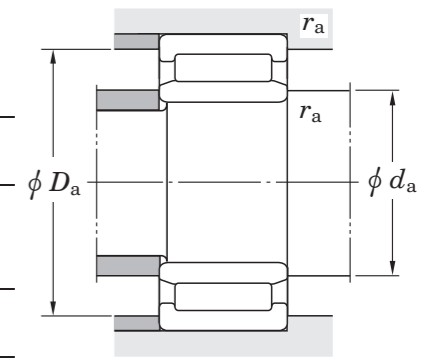

[Note] 1) Limiting speeds of bearing number NA49...UU indicates the value of sealed and grease lubricated bearings.
 [Remark] Limiting speed of grease lubrication should be kept to unber 60 % of that for oil lubrication.

Machined ring needle roller bearings

F_w 110 ~ 160 mm

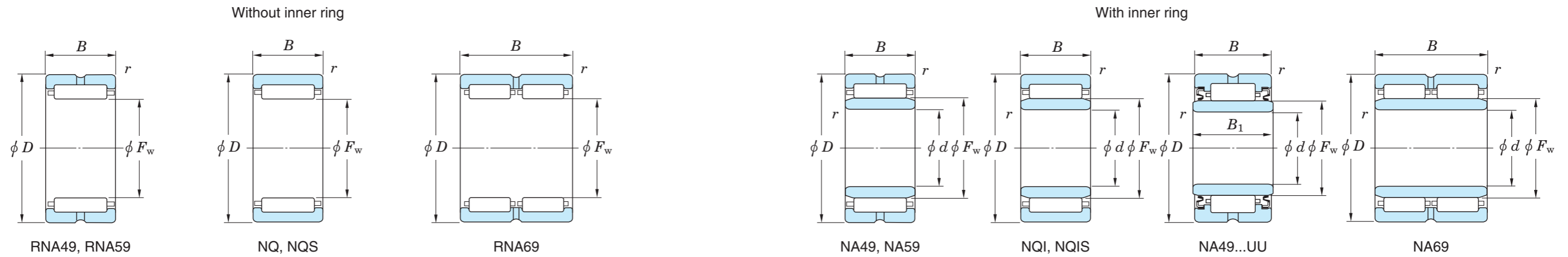

F_w	Boundary dimensions (mm)					Basic load ratings (kN)		Limiting speeds ¹⁾ (min ⁻¹) Oil lub.	Bearing No.		Mounting dimensions (mm)			(Refer.) Mass (kg)		(Refer.) Applicable inner ring No.
	d	D	B	B_1	$r_{min.}$	C_r	C_{0r}		Without inner ring	With inner ring	d_a min.	D_a max.	r_a max.	Without inner ring	With inner ring	
110	95	130	35	—	1.1	115.0	253.0	4 200	RNA4919	NA4919	101.5	123.5	1	0.728	1.37	IRM9511035 IRM9511046 IRM9511063
	95	130	46	—	1.1	141.0	331.0		RNA5919	NA5919	101.5	123.5	1	0.940	1.78	
	95	130	63	—	1.1	173.0	428.0		RNA6919	NA6919	101.5	123.5	1	1.27	2.43	
115	100	140	40	—	1.1	144.0	296.0	4 000	RNA4920	NA4920	106.5	133.5	1	1.160	1.86	IRM10011540 IRM10011554
	100	140	54	—	1.1	189.0	418.0		RNA5920	NA5920	106.5	133.5	1	1.49	2.53	
125	110	150	40	—	1.1	149.0	317.0	3 700	RNA4922	NA4922	116.5	143.5	1	1.17	2.01	IRM11012540 IRM11012554
	110	150	54	—	1.1	195.0	448.0		RNA5922	NA5922	116.5	143.5	1	1.690	2.74	
135	120	165	45	—	1.1	192.0	398.0	3 400	RNA4924	NA4924	126.5	158.5	1	1.75	2.78	IRM12013545 IRM12013560
	120	165	60	—	1.1	244.0	564.0		RNA5924	NA5924	126.5	158.5	1	2.43	3.80	
150	130	180	50	—	1.5	225.0	508.0	3 000	RNA4926	NA4926	138	172	1.5	2.21	3.83	IRM13015050 IRM13015067
	130	180	67	—	1.5	274.0	655.0		RNA5926	NA5926	138	172	1.5	3.000	5.09	
160	140	190	50	—	1.5	232.0	540.0	2 800	RNA4928	NA4928	148	182	1.5	2.350	4.08	IRM14016050 IRM14016067
	140	190	67	—	1.5	283.0	696.0		RNA5928	NA5928	148	182	1.5	3.02	5.42	

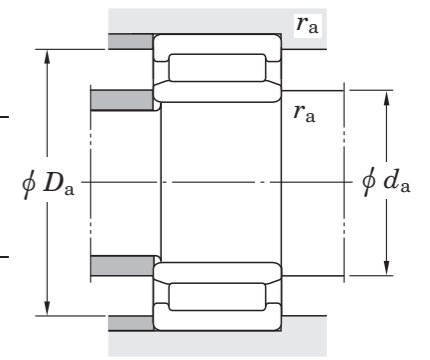

[Note] 1) Limiting speeds of bearing number NA49...UU indicates the value of sealed and grease lubricated bearings.

[Remark] Limiting speed of grease lubrication should be kept to unber 60 % of that for oil lubrication.



Inner rings for needle roller bearings



**NEEDLE
ROLLER
BEARINGS**

Inner rings for needle roller bearings

d 8 ~ (20) mm

d (20) ~ 35 mm

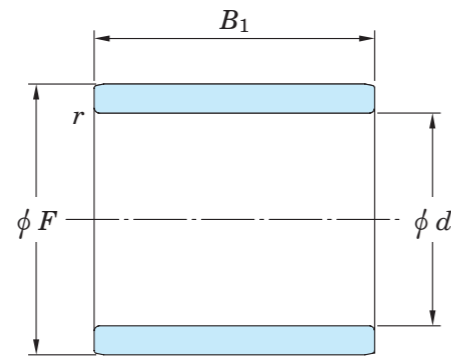

IRM

Boundary dimensions (mm)				Bearing No.	Dimensional tolerances (μm)		(Refer.) Mass (g)
d	F	B_1	r min.		Raceway contact diameter $F^{1)}$		
					Upper	Lower	
8	12	10.5	0.3	IRM810	0	-8	5.1
	12	12.5	0.3	IRM812-1	0	-8	6.1
	12	15.5	0.3	IRM815	0	-8	7.5
10	14	12.5	0.3	IRM1012	0	-8	7.3
	14	13.5	0.3	IRM1013	0	-8	7.9
	14	14	0.3	IRM101414	0	-8	8
12	15	12.5	0.3	IRM1212	0	-8	6.1
	15	16.5	0.3	IRM1216	0	-8	8.1
	16	13	0.3	IRM121613	0	-8	9
	16	14	0.3	IRM121614	0	-8	9.5
	16	16.5	0.3	IRM1216-1	0	-8	11
	16	22	0.3	IRM121622	0	-8	15
	17	15.0	0.3	IRM1215	0	-8	13
15	18	12.5	0.3	IRM1512	0	-8	7.3
	20	13	0.3	IRM152013	0	-8	13
	20	14	0.3	IRM152014	0	-8	15
	20	18	0.3	IRM152018	0	-8	19
	20	20.5	0.3	15IRM2021	0	-9	21
	20	23	0.3	IRM152023	0	-8	24
17	22	13	0.3	IRM172213	0	-8	15
	22	14	0.3	IRM172214	0	-8	16
	22	18	0.3	IRM172218	0	-8	21
	22	23	0.3	IRM172223	0	-8	27
20	25	15.5	0.3	IRM2015	0	-9	21
	25	16	0.3	IRM2016A	0	-9	21
	25	16.5	0.3	IRM2016	0	-9	23
	25	17	0.3	IRM202517	0	-9	23

Boundary dimensions (mm)				Bearing No.	Dimensional tolerances (μm)		(Refer.) Mass (g)
d	F	B_1	r min.		Raceway contact diameter $F^{1)}$		
					Upper	Lower	
20	25	18	0.3	IRM202518	0	-9	24
	25	23	0.3	IRM202523	0	-9	31
	25	25.5	0.3	IRM2025	0	-9	35
	25	26.5	0.3	IRM2026	0	-9	36
	25	27.5	0.3	IRM2027	0	-9	38
	25	30	0.3	IRM202530	0	-9	41
	30	16	0.3	20IRM3016	0	-9	48
22	28	17	0.3	IRM222817	0	-9	30
	28	30	0.3	IRM222830	0	-9	54
25	30	17	0.3	IRM253017	0	-9	28
	30	18	0.3	IRM253018	0	-9	30
	30	20.5	0.3	IRM2520	0	-9	34
	30	23	0.3	IRM253023	0	-9	39
	30	30	0.3	IRM253030	0	-9	50
28	32	17	0.3	IRM283217	0	-9	24
30	35	17	0.3	IRM303517	0	-9	33
	35	18	0.3	IRM303518	0	-9	35
	35	23	0.3	IRM303523	0	-9	45
	35	30	0.3	IRM303530	0	-9	60
32	40	20	0.6	IRM324020	0	-11	68
35	40	20.5	0.6	IRM3520	0	-11	46
	42	20	0.6	IRM354220	0	-11	65
	42	21	0.6	IRM354221	0	-11	68
	42	27.5	0.6	IRM354227	0	-11	87
	42	30	0.3	35IRM4230	0	-11	97
	42	36	0.6	IRM354236	0	-11	115

[Note] 1) Tolerances of raceway contact diameter (F) conform to h5 of JIS B0401.

[Remark] Tolerances of bore (d) and width (B_1) conform to JIS B1536 (refer to page 119).

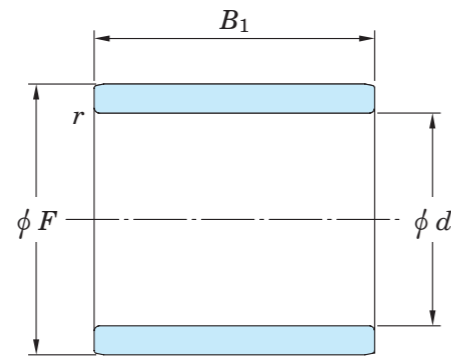

IRM

Boundary dimensions (mm)				Bearing No.	Dimensional tolerances (μm)		(Refer.) Mass (g)
d	F	B_1	r min.		Raceway contact diameter $F^{1)}$		
					Upper	Lower	
40	45	20.5	0.6	IRM4020	0	-11	52
	45	30.5	0.6	IRM4030	0	-11	77
	48	22	0.6	IRM404822	0	-11	92
	48	23	0.6	IRM404823	0	-11	97
	48	30	0.6	IRM404830	0	-11	126
	48	40	0.6	IRM404840	0	-11	168
45	52	22	0.6	IRM455222	0	-11	89
	52	23	0.6	IRM455223	0	-11	93
	52	30	0.6	IRM455230	0	-11	113
	52	40	0.6	IRM455240	0	-11	162
50	58	22	0.6	IRM505822	0	-11	114
	58	30	0.6	IRM505830	0	-11	154
	58	40	0.6	IRM505840	0	-11	206
55	63	25	1	IRM556325	0	-13	141
	63	34	1	IRM556334	0	-13	192
	63	45	1	IRM556345	0	-13	253
60	68	25	1	IRM606825	0	-13	153
	68	34	1	IRM606834	0	-13	207
	68	45	1	IRM606845	0	-13	275
65	72	25	1	IRM657225	0	-13	143
	72	34	1	IRM657234	0	-13	194
	72	45	1	IRM657245	0	-13	257
70	80	30	1	IRM708030	0	-13	268
	80	40	1	IRM708040	0	-13	358
	80	54	1	IRM708054	0	-13	543
75	85	30	1	IRM758530	0	-13	286

Boundary dimensions (mm)				Bearing No.	Dimensional tolerances (μm)		(Refer.) Mass (g)
d	F	B_1	r min.		Raceway contact diameter $F^{1)}$		
					Upper	Lower	
75	85	40	1	IRM758540	0	-13	386
	85	54	1	IRM758554	0	-13	574
80	90	30	1	IRM809030	0	-13	304
	90	40	1	IRM809040	0	-13	409
	90	54	1	IRM809054	0	-13	544
85	100	35	1.1	IRM8510035	0	-15	581
	100	46	1.1	IRM8510046	0	-15	759
	100	63	1.1	IRM8510063	0	-15	1 120
90	105	35	1.1	IRM9010535	0	-15	615
	105	46	1.1	IRM9010546	0	-15	802
	105	63	1.1	IRM9010563	0	-15	1 100
95	110	35	1.1	IRM9511035	0	-15	642
	110	46	1.1	IRM9511046	0	-15	840
	110	63	1.1	IRM9511063	0	-15	1 160
100	115	40	1.1	IRM10011540	0	-15	767
	115	54	1.1	IRM10011554	0	-15	1 040
110	125	40	1.1	IRM11012540	0	-15	839
	125	54	1.1	IRM11012554	0	-15	1 140
120	135	45	1.1	IRM12013545	0	-15	1 026
	135	60	1.1	IRM12013560	0	-15	1 370
130	150	50	1.5	IRM13015050	0	-18	1 669
	150	67	1.5	IRM13015067	0	-18	2 240
140	160	50	1.5	IRM14016050	0	-18	1 793
	160	67	1.5	IRM14016067	0	-18	2 400

[Note] 1) Tolerances of raceway contact diameter (F) conform to h5 of JIS B0401.

[Remark] Tolerances of bore (d) and width (B_1) conform to JIS B1536 (refer to page 119).



Needle roller thrust bearings



NEEDLE
ROLLER
BEARINGS

Needle roller thrust bearings

In Koyo needle roller thrust bearings, separable type comprising needle roller and cage thrust assemblies (TV, TP) and race (W, WS), and TVK and TPK in which precisely pressed race and needle roller and cage thrust assemblies are assembled as a non-separable type are available.

The needle roller thrust bearing does not occupy much space and can be used in the space where the conventional collar is used.

Furthermore, a compact machine set up is possible if it is used in combination with the radial type needle roller bearing. This type of bearing is widely employed in the speed reducers and transmission units of cars, cultivators, machine tools, etc.

[Remark] The race indicates the thrust washer or washer specified in JIS.

1 Bearing number

(Ex. 1)

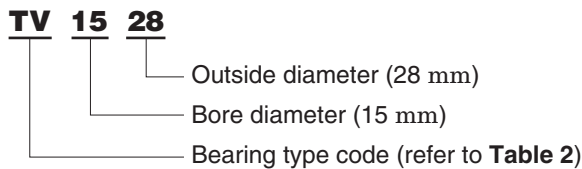

(Ex. 2)

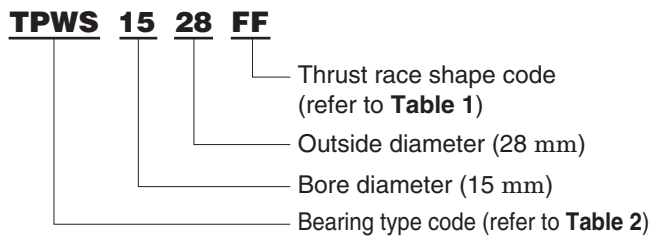

(Ex. 3)

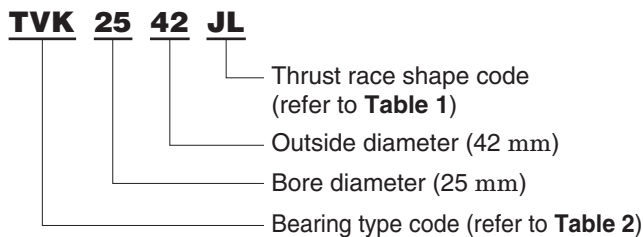

Table 1 Shape code of thrust races

Code	Type	Profile
F	Flat race	
L	Bore diameter flanged (or claw)	
J	Outside diameter flanged (or claw)	
Z	Special shape	

Table 2 Type code of bearings and thrust races

Type	Code	Remarks
Needle roller and cage thrust assembly	TV	
	TP	
Race	W	Thin plate race (pressed)
	WS	Thick plate race (machined)
Combination bearing examples	TPW...F	TP+W
	TPWS...FF	TP+WS+WS
	TPWWS...FF	TP+W+WS
Non-separable bearing examples	TVK...	The non-separable type bearing comprises needle roller and cage thrust assembly and races.
	TPK...	

2 Mounting Surface Accuracy

When mounting the needle roller thrust bearing using the mounting surface of associated components as the raceway surface, the surface must satisfy the specifications shown in **Table 3**.

Table 3 Mounting surface accuracy

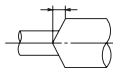
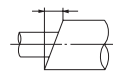
Squareness	 25 μm or less per 25 mm
	 12.5 μm or less per 25 mm
Roughness (Ra)	0.4 α or less
Hardness	58 HRC or harder (60 thru 64 HRC is best.) (refer to page 17 above regarding depth.)

3 Tolerances

The Koyo needle roller thrust bearing are manufactured according to specifications shown in **Tables 4 to 6**.

Table 4 Tolerances for needle roller and cage thrust assemblies (type code : TV, TP)

(1) Bore diameter Unit : μm

Cage bore diameter d_c (mm)		Minimum single bore ($d_{cs\ min}$) diameter deviation ¹⁾		Single plane bore diameter variation $V_{d_{esp}}$
over	up to	upper	lower	max.
6	10	+115	+25	90
10	18	+142	+32	110
18	30	+170	+40	130
30	50	+210	+50	160
50	80	+250	+60	190
80	120	+292	+72	220

(2) Outside diameter Unit : μm

Cage outside diameter D_c (mm)		Maximum single outside ($D_{cs\ max}$) diameter deviation ¹⁾		Single plane outside diameter variation $V_{D_{esp}}$
over	up to	upper	lower	max.
18	30	-110	-320	210
30	40	-120	-370	250
40	50	-130	-380	250
50	65	-140	-440	300
65	80	-150	-450	300
80	100	-170	-520	350
100	120	-180	-530	350
120	140	-200	-600	400

[Note] 1) The tolerances indicate the limits of differences between $d_{cs\ min}$ and d_c .

[Remark] The tolerances of thickness conform to JIS B 1506 in a similar manner to roller diameter (D_w) (refer to page 177).

[Note] 1) The tolerances indicate the limits of differences between $D_{cs\ max}$ and D_c .

[Remark] The tolerances of thickness conform to JIS B 1506 in a similar manner to roller diameter (D_w) (refer to page 177).

Table 5 Tolerances for races = JIS B 1536 =

(1) Bore diameter (type code : W) Unit : μm

Race bore diameter d (mm)		Minimum single bore ($d_{s\ min}$) diameter deviation ¹⁾		Single plane bore diameter variation $V_{d_{sp}}$
over	up to	upper	lower	max.
6	10	+175	+25	120
10	18	+212	+32	180
18	30	+250	+40	210
30	50	+300	+50	250
50	80	+360	+60	300
80	120	+422	+72	350

(2) Outside diameter (type code : W) Unit : μm

Race outside diameter D (mm)		Maximum single outside ($D_{s\ max}$) diameter deviation ¹⁾		Single plane outside diameter variation $V_{D_{sp}}$
over	up to	upper	lower	max.
18	30	-40	-250	330
30	50	-50	-300	390
50	80	-60	-360	460
80	120	-72	-422	540
120	180	-85	-485	630

[Note] 1) The tolerances indicate the limits of differences between $d_{s\ min}$ and d .

[Remark] Tolerances of thickness (S) shall be equivalent to tolerance class js12 of JIS B 0401-2.

[Note] 1) The tolerances indicate the limits of differences between $D_{s\ max}$ and D .

[Remarks] 1) Tolerances of thickness (S) shall be equivalent to tolerance class js12 of JIS B 0401-2.
2) Values in Italics are prescribed in JTEKT standards.

Table 5 Tolerances for races

(3) Bore diameter (type code : WS) Unit : μm

Race bore diameter d (mm)		Minimum single bore ($d_{s\text{ min}}$) diameter deviation ¹⁾		Single plane bore diameter variation V_{dsp}
over	up to	upper	lower	max.
6	10	+175	+25	120
10	18	+212	+32	180
18	30	+250	+40	210
30	50	+300	+50	250
50	80	+360	+60	300
80	120	+422	+72	350

[Note] 1) The tolerances indicate the limits of differences between $d_{s\text{ min}}$ and d .

[Remarks] 1) Tolerances of thickness (S) shall be equivalent to tolerance class js12 of JIS B 0401-2.

2) Values in Italics are prescribed in JTEKT standards.

(4) Outside diameter (type code : WS) Unit : μm

Race outside diameter D (mm)		Maximum single outside ($D_{s\text{ max}}$) diameter deviation ¹⁾		Single plane outside diameter variation V_{Dsp}
over	up to	upper	lower	max.
18	30	-40	-250	330
30	50	-50	-300	390
50	80	-60	-360	460
80	120	-72	-422	540
120	180	-85	-485	630

[Note] 1) The tolerances indicate the limits of differences between $D_{s\text{ max}}$ and D .

[Remarks] 1) Tolerances of thickness (S) shall be equivalent to tolerance class js12 of JIS B 0401-2.

2) Values in Italics are prescribed in JTEKT standards.

Table 6 Tolerances for non-separable needle roller thrust bearings (type code : TVK, TPK)

(1) Bore diameter Unit : μm

Race bore diameter d (mm)		Minimum single bore ($d_{s\text{ min}}$) diameter deviation ¹⁾		Single plane bore diameter variation V_{dsp}
over	up to	upper	lower	max.
18	30	+250	+40	210
30	50	+300	+50	250
50	80	+360	+60	300

[Note] 1) The tolerances indicate the limits of differences between $d_{s\text{ min}}$ and d .

[Remark] Values in Italics are prescribed in JTEKT standards.

(2) Outside diameter Unit : μm

Race outside diameter D (mm)		Maximum single outside ($D_{s\text{ max}}$) diameter deviation ¹⁾		Single plane outside diameter variation V_{Dsp}
over	up to	upper	lower	max.
30	50	-50	-300	250
50	80	-60	-360	300
80	120	-72	-422	350

[Note] 1) The tolerances indicate the limits of differences between $D_{s\text{ max}}$ and D .

[Remark] Values in Italics are prescribed in JTEKT standards.

4 Fits

Recommended fit for Koyo needle roller thrust bearings is as shown in **Table 7**.

Table 7 Recommended fit

Distinction	Type code	Guide	Tolerance class	
			Shaft	Housing bore
Needle roller and cage thrust assembly	TV TP	Inside	h8	—
		Outside	—	H8
Race	W WS	Inside	h8	—
		Outside	—	H8
Non-separable bearing	TVK (TPK) ...JL TVK (TPK) ...J TVK (TPK) ...L	Inside	h8	—
		Outside	—	H8

[Remark] This tolerance class is applicable when the tolerances of bore and outside diameters of bearings are standard.

Needle roller thrust bearings

$d (d_1)$ 10 ~ 22 mm

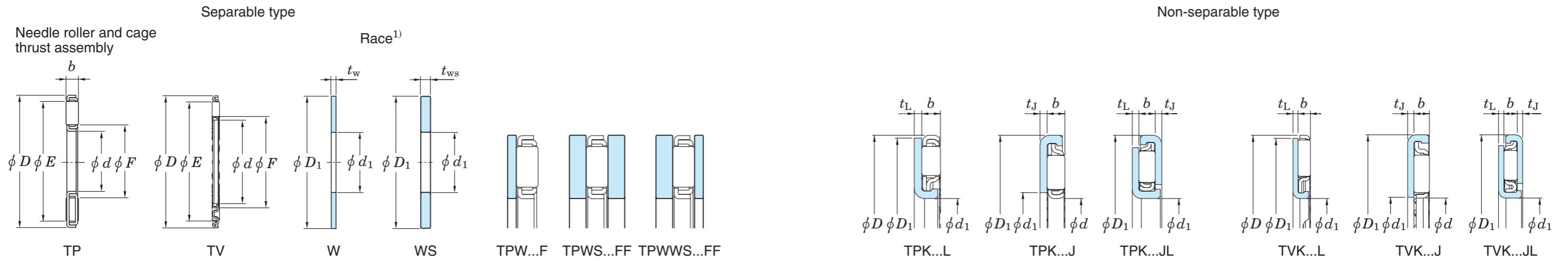

Boundary dimensions (mm)									Basic load ratings (kN)		Limiting speeds (min ⁻¹)	Bearing No.				Dimensions (mm)		(Refer.) Mass (g)			
d	d_1	D	D_1	b	t_w	t_J	t_{ws}	t_L	C_a	C_{0a}	Oil lub.	Needle roller and cage thrust ass'y Separable type	Non-separable type	Thin plate race (pressed)	Thick plate race (machined)	E	F	[TP TV]	[TPK TVK]	(W)	(WS)
10	10	24	24	2	1.0	—	2	—	6.35	18.3	12 000	TP1024-1	—	W1024F	WS1024F	15.2	21.8	3.5	—	2.9	5.8
	—	23	—	2	—	—	—	—	8	24	12 000	TV1023	—	—	—	12.6	21.8	2.5	—	—	—
12	—	24	—	2	—	—	—	—	3.75	9	12 000	TP1224	—	—	—	14.1	22.1	3.0	—	—	—
	12	25.8	26	2	1.0	—	2	—	6.55	19.79	11 000	TP1226B	—	W1226F	WS1226F	17.3	23.5	3.6	—	3.3	6.6
	12	26	26	2	1.0	—	2	—	8.6	27.5	11 000	TV1226	—	W1226F	WS1226BF	14.6	23.8	3.8	—	3.3	6.6
14	14	27	27	2	1	—	2.75	—	6.55	19.8	11 000	TP1427	—	W1427F	WS1427F	24.5	16.5	3.6	—	3.2	9.0
15	15	32.3	32	2	1.0	—	—	—	11	42.1	10 000	TP1532-1	—	W1532F	—	22.3	30.3	6.1	—	4.6	—
	15	28	28	2	1.0	—	2	—	9.85	34.3	11 000	TV1528	—	W1528F	WS1528F	17.6	26.8	4.1	—	3.4	6.8
16	16	29	29	2	1.5	—	2.75	—	9.15	31.4	11 000	TP1629	—	W1629AF	WS1629F	26.5	18.5	4.4	—	5.4	9.9
17	17	30	30	2	0.8	—	2.75	—	9.40	32.9	10 000	TP1730	—	W1730F	WS1730F	27.5	19.5	4.4	—	3.0	10
	17	40	40	2.5	—	—	3	—	17.9	69.3	8 000	TP1740	—	—	WS1740F	36.5	22.7	11	—	—	24
	17	34	34	2.5	—	—	2.155	—	14.1	49.5	8 700	TV1734	—	—	WS1734-2F	21.1	32.5	8.2	—	—	11
18	18	31	31	2	1.0	—	2	—	9.65	34.4	10 200	TP1831	—	W1831F	WS1831F	20.4	28.4	5.0	—	3.9	7.8
—	18.1	31.6	31	2	—	—	—	0.8	7.45	25.2	10 000	—	TPK1832L	—	—	22.8	29.4	—	8	—	—
—	18.75	—	39.7	1.984	—	0.8	—	0.8	9.8	37.4	9 000	—	TVK1940JL	—	—	25	34.2	—	17	—	—
19.6	21	—	35.9	2	—	0.8	—	—	6	18.7	9 400	—	TPK2036J-1	—	—	21.8	28	—	10	—	—
20	20	35	35	2	1	—	2.75	—	13.2	53.6	9 600	TP2035-1	—	W2035F	WS2035F	32.5	22.9	5.9	—	5.1	14
20.9	—	32	—	2	—	—	—	—	8.4	29.7	10 000	TP2132D	—	—	—	23.5	29.7	4.6	—	—	—
21.9	—	34	—	2	—	—	—	—	8.05	28.6	9 700	TP2234	—	—	—	25	31.2	5.1	—	—	—
22	22	37	37	2	1	—	2.75	—	12.6	51.7	9 300	TP2237-1	—	W2237F	WS2237F	34.5	22.9	6.4	—	5.4	15
	—	22	41	41	2	—	—	0.8	13.2	56.8	8 800	—	TPK2241L	—	—	28	38	—	15	—	—

[Note] 1) In JIS, it is called a thrust washer or washer.

Needle roller thrust bearings

$d (d_1)$ 22.2 ~ 31.85 mm

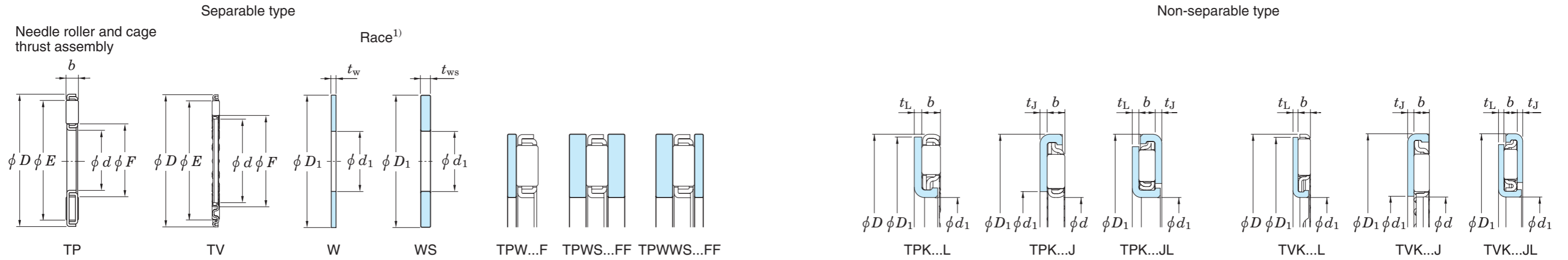

Boundary dimensions (mm)									Basic load ratings (kN)		Limiting speeds (min ⁻¹)	Bearing No.				Dimensions (mm)		(Refer.) Mass (g)			
d	d_1	D	D_1	b	t_w	t_J	t_{ws}	t_L	C_a	C_{0a}	Oil lub.	Needle roller and cage thrust ass'y Separable type	Thin plate race Non-separable type	Thin plate race (pressed)	Thick plate race (machined)	E	F	[TP TV]	[TPK TVK]	(W)	(WS)
22.2	—	36.1	—	1.984	—	—	—	—	9.95	38.2	9 500	TP2236A-1	—	—	—	25.3	33.3	6.1	—	—	—
22.7	22	—	35.1	2	—	0.8	—	—	8.3	29.7	9 500	—	TPK2235J	—	—	25	31.2	—	9.1	—	—
22.8	22	—	37.95	1.984	—	0.8	—	—	10.6	40.9	9 200	—	TVK2238J	—	—	24	33.2	—	11	—	—
25	25	42	42	2	1.0	—	3	—	14.8	66.2	8 700	TP2542	—	W2542F	WS2542KF	28.6	39.2	8.6	—	7	21
	25	—	39.5	2.5	—	0.8	—	—	14	51.5	8 100	—	TVK2540J	—	—	26.2	35.4	—	12.4	—	—
25.8	26	—	42	1.984	—	0.8	—	—	12.8	54.4	8 800	—	TVK2642J	—	—	27	37	—	13	—	—
26	—	38.66	—	2	—	—	—	—	10.4	41.2	9 100	TV2639-1	—	—	—	28.2	37.4	5.5	—	—	—
	—	26	—	43.4	1.984	—	0.8	0.8	11.5	49	8 600	—	TPK2643JL	—	—	30.6	38.6	—	19	—	—
28	—	41	—	2	—	—	—	—	9.4	37.4	8 800	TP2841C	—	—	—	31.5	37.7	6.7	—	—	—
	28	45	45	2	0.8	—	3	—	15.1	70.3	8 400	TP2845	—	W2845F	WS2845F	42.5	31.9	9.0	—	6.1	19
	28	—	42.6	2	—	0.8	—	—	9.4	37.4	8 700	—	TPK2843AJ	—	—	31.5	37.7	—	13	—	—
28.5	28.5	46.15	46.15	2	0.8	—	—	—	12.1	52.4	8 300	TP2946A	—	W2946AF	—	32.4	40.4	9.3	—	6.5	—
28.9	—	42	—	1.984	—	—	—	—	11.7	50.4	8 800	TP2942A-1	—	—	—	31.6	39.6	7.2	—	—	—
—	29	47.21	47	2	—	—	—	1	15.9	76	8 300	—	TVK2947L	—	—	34	45	—	18	—	—
	—	29	48.4	49	3	—	—	0.8	21.8	87.4	6 600	—	TVK2949L	—	—	35	47	—	22	—	—
30	30	47	47	2	1.0	—	2	—	16.2	78.6	8 300	TP3047-1	—	W3047F	WS3047F	34	44.6	10	—	8.1	16.2
—	30.1	45.5	45.5	1.984	—	—	—	0.8	12.4	55.9	8 400	—	TPK3046L	—	—	35	42.6	—	14	—	—
	—	30.1	—	47.3	1.984	—	0.8	0.8	12.4	55.9	8 300	—	TPK3047JL-1	—	—	35	42.6	—	21	—	—
—	30.7	—	46.02	1.984	—	0.8	—	0.8	12.5	56.2	8 400	—	TPK3146JL-4	—	—	34.5	42.3	—	19	—	—
	—	30.7	—	46.43	1.984	—	1	0.8	12.5	56.2	8 300	—	TPK3146JL-5	—	—	34.5	42.3	—	21	—	—
—	31.85	45.1	45.2	1.984	—	—	—	0.8	12.1	54.7	8 400	—	TVK3245L	—	—	36.2	44.2	—	12	—	—

[Note] 1) In JIS, it is called a thrust washer or washer.

Needle roller thrust bearings

$d (d_1)$ 32 ~ 43.45 mm

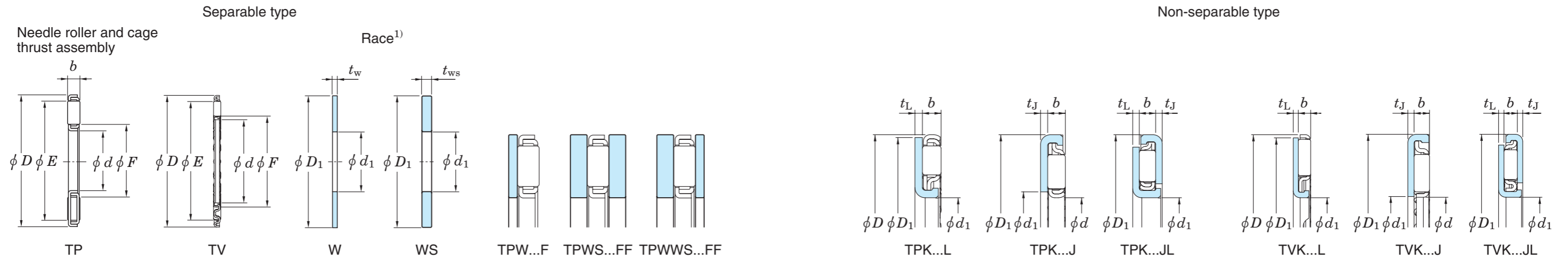

Boundary dimensions (mm)									Basic load ratings (kN)		Limiting speeds (min ⁻¹)	Bearing No.				Dimensions (mm)		(Refer.) Mass (g)			
d	d_1	D	D_1	b	t_w	t_J	t_{ws}	t_L	C_a	C_{0a}	Oil lub.	Needle roller and cage thrust ass'y Separable type	Thin plate race Non-separable type	Thin plate race (pressed)	Thick plate race (machined)	E	F	[TP] [TV]	[TPK] [TVK]	(W)	(WS)
32	32	49	49	2	1	—	3	—	17.3	86.2	8 100	TP3249	—	W3249F	WS3249F	46.5	35.9	10	—	8.5	25
—	32.9	53.1	53.1	1.984	—	—	—	0.8	18.4	97.2	7 800	—	TVK3353L	—	—	39.8	51.8	—	20	—	—
33.5	—	45	—	2	—	—	—	—	8.5	34.3	8 400	TP3445A	—	—	—	37	42.6	6.8	—	—	—
33.7	33.8	—	48.2	1.984	—	0.8	—	—	13.6	63	8 200	—	TVK3448J-1	—	—	35	44.2	—	14	—	—
—	34	—	51.4	2	—	0.8	—	0.8	12.6	58.1	7 900	—	TPK3451JL	—	—	38.6	46.6	—	23	—	—
34.65	35	52	52	2	1.0	—	3	—	17.1	86.9	7 800	TP3552B	—	W3552F	WS3552AF	38.4	49	11	—	9.1	27
—	34.6	58.4	58.2	2	0.8	—	—	—	20.5	114	7 400	TP3558	—	W3558F	—	44	56	16	—	11	—
—	34.6	58.4	58.2	2	0.8	—	—	—	22.4	128	7 400	TP3558-1	—	W3558F	—	42	56	16	—	11	—
—	37.4	57.3	57.3	1.984	—	—	—	0.8	19.3	106	7 500	—	TVK3757L	—	—	44	56	—	23	—	—
—	38	—	53	2	—	0.8	—	0.8	11.6	53.8	7 800	—	TPK3853JL	—	—	42.4	49	—	22	—	—
—	38	—	58	3	—	0.8	—	1	24.9	91.5	6 100	—	TPK3858JL	—	—	43.2	53.2	—	41	—	—
38.07	38	—	52	2	—	0.8	—	—	12	55.2	7 800	—	TVK3852J-1	—	—	39.8	47.8	—	15	—	—
38.15	38.15	55.29	55.29	1.984	0.8	—	3.0	—	19.9	108	7 600	TP3855A	—	W3855F	WS3855F	40.59	52.59	13	—	13	49
39.6	—	58.1	—	3	—	—	—	—	25.8	115	6 100	TP4058-1	—	—	—	43.3	55.3	22	—	—	—
40	40	60	60	3	1.0	—	2	—	23.5	103	6 000	TP4060	—	W4060F	WS4060F	44.4	56	23	—	12	24
41	—	68	—	9	—	—	—	—	75.8	222	3 200	TP4168	—	—	—	45.4	63.8	104	—	—	—
42	—	62	—	3	—	—	—	—	17.5	71.4	5 900	TP4262	—	—	—	47.8	56.4	23	—	—	—
—	42.5	—	61.2	1.984	—	0.8	—	0.8	15.5	81.7	7 300	—	TVK4361JL-2	—	—	47.6	56.8	—	29	—	—
—	43.45	—	61.2	1.984	—	0.8	—	0.8	14.6	74.9	7 300	—	TVK4361JL	—	—	47.6	56.8	—	29	—	—
—	43.45	—	61.74	1.984	—	1.1	—	0.8	14.6	74.9	7 200	—	TVK4362JL	—	—	47.6	56.8	—	32	—	—

[Note] 1) In JIS, it is called a thrust washer or washer.

Needle roller thrust bearings

d (d₁) 45 ~ 65 mm

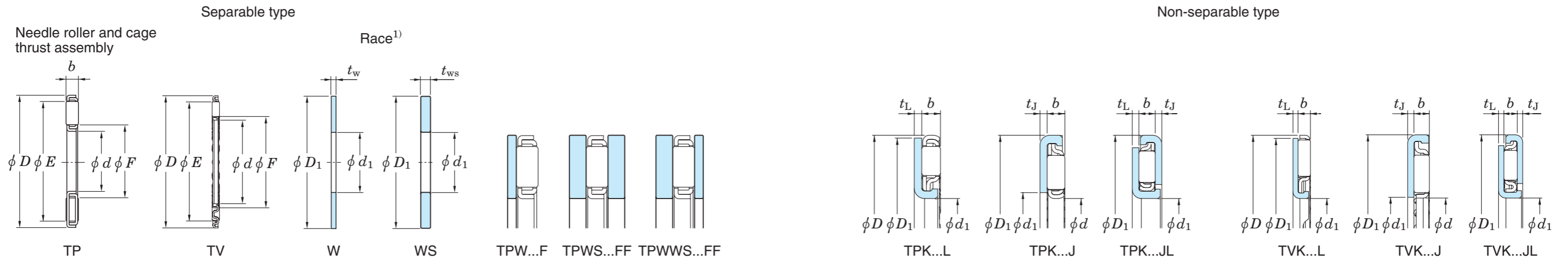

Boundary dimensions (mm)									Basic load ratings (kN)		Limiting speeds (min ⁻¹)	Bearing No.				Dimensions (mm)		(Refer.) Mass (g)			
d	d ₁	D	D ₁	b	t _w	t _J	t _{ws}	t _L	C _a	C _{0a}	Oil lub.	Needle roller and cage thrust ass'y Separable type	Non-separable type	Thin plate race (pressed)	Thick plate race (machined)	E	F	[TP TV]	[TPK TVK]	(W)	(WS)
45	45.24	62.19	62.2	1.984	0.8	—	2	—	20.3	115	7 200	TV4562	—	W4562F	WS4562AF	46.2	58.6	14	—	8.8	22
	45	56	56	2	1.0	—	2	—	9	39.6	7 600	TP4556	—	W4556F	WS4556F	47.5	53.7	8.4	—	6.8	13.6
	45	65	65	3	1.5	—	2	—	25.2	116	5 700	TP4565A	—	W4565AF	WS4565F	49.4	61	26	—	20	27
46.4	—	68	—	3.5	—	—	—	—	38.4	182	5 200	TP4668-2	—	—	—	49.4	65	35	—	—	—
—	48.25	—	72	3	—	0.8	—	0.8	30.9	129	5 400	—	TVK4872JL	—	—	54	66	—	56	—	—
49	49.1	70.65	71	1.984	0.8	—	1.84	—	18	105	6 800	TV4971	—	W4971AF	WS4971F-1	58.4	68.4	17	—	13	30
50	50	70	70	3	1.0	—	2	—	26.7	129	5 500	TP5070	—	W5070F	WS5070F	54.4	66	28	—	15	30
52	—	72.6	—	1.984	—	—	—	—	26	169	6 700	TV5273	—	—	—	56	71.2	19	—	—	—
—	53.6	—	69.6	1.984	—	0.8	—	0.8	15.9	89.3	6 800	—	TPK5470JL-3	—	—	57.4	65.2	—	32	—	—
—	53.6	—	70.18	1.984	—	1.1	—	0.8	15.9	89.3	6 800	—	TPK5470JL-4	—	—	57.4	65.2	—	36	—	—
55	55	78	78	3	1	—	4	—	32.4	171	5 200	TP5578	—	W5578F	WS5578F	60.4	74	33	—	19	75
55.48	56.8	—	69.6	1.984	—	0.8	—	—	15.9	89.3	6 800	—	TPK5570J	—	—	57.4	65.2	—	20	—	—
—	55.9	—	76	1.984	—	0.8	—	0.8	16.2	91.9	6 500	—	TVK5676JL	—	—	60.6	69.8	—	40	—	—
—	55.9	—	76.6	1.984	—	1.1	—	0.8	16.2	91.9	6 500	—	TVK5677JL	—	—	60.6	69.8	—	41	—	—
—	57	70.8	71	1.984	—	—	—	0.8	14.6	80.7	6 700	—	TVK5771L	—	—	61.8	69.8	—	20	—	—
60	60	85	85	3	1	—	5	—	38.3	218	5 000	TP6085	—	W6085F	WS6085F	81	65.4	40	—	22	112
—	60.4	—	78	2	—	0.8	—	0.8	17.9	107	6 400	—	TPK6078JL	—	—	65.6	73.6	—	38	—	—
62	—	80.25	—	2	—	—	—	—	23.3	151	6 300	TP6280A	—	—	—	65.2	76.8	20	—	—	—
—	63	77.73	78	2	—	—	—	0.8	13.6	75.5	6 400	—	TVK6378L	—	—	68	76	—	23	—	—
65	65	90	90	3	1	—	5	—	40.1	236	4 900	TP6590	—	W6590F	WS6590F	86	70.4	43	—	24	119

[Note] 1) In JIS, it is called a thrust washer or washer.

Needle roller thrust bearings

d (d_1) 70 ~ 100 mm

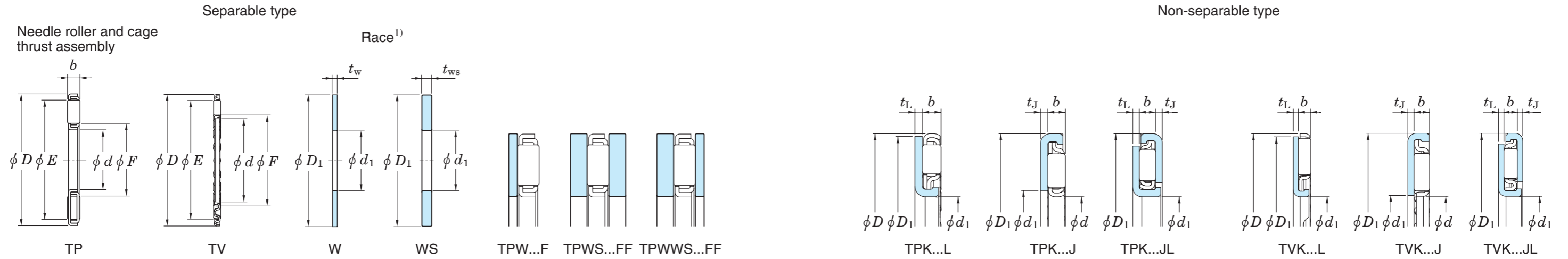

Boundary dimensions (mm)									Basic load ratings (kN)		Limiting speeds (min ⁻¹)	Bearing No.				Dimensions (mm)		(Refer.) Mass (g)			
d	d_1	D	D_1	b	t_w	t_J	t_{ws}	t_L	C_a	C_{0a}	Oil lub.	Needle roller and cage thrust ass'y Separable type	Non-separable type	Thin plate race (pressed)	Thick plate race (machined)	E	F	[TP TV]	[TPK TVK]	(W)	(WS)
70	70	95	95	4	1	—	3	—	52.1	275	4 100	TP7095	—	W7095F	WS7095F	74.2	90.2	70	—	25	75
70.03	—	92.37	—	3.175	—	—	—	—	33.4	181	4 700	TV7092A	—	—	—	75	87.4	34	—	—	—
—	71.9	85.6	85.5	2	—	0.8	—	—	14.1	82.4	6 100	—	TPK7286L	—	—	76.5	83.1	—	27	—	—
—	73.6	—	89.6	2	—	0.8	—	0.8	10	52.6	6 000	—	TPK7490JL	—	—	78	84.6	—	41	—	—
75	75	100	100	4	2	—	5	—	46.7	243	4 000	TP75100	—	W75100F	WS75100F	95	79.4	63	—	54	135
80	80	105	105	4	1	—	6	—	47.8	255	3 900	TP80105	—	W80105F	WS80105F	100	84.4	67	—	29	171
82.68	—	114.3	—	9.525	—	—	—	—	117	453	2 400	TP83114	—	—	—	88.6	109	218	—	—	—
—	83.1	—	104	2	—	2	—	0.8	14.7	90	5 500	—	TVK83104JL	—	—	88.8	96.8	—	77	—	—
85	85	110	110	4	1	—	6	—	48.9	266	3 800	TP85110	—	W85110F	WS85110F	105	89.4	70	—	30	180
90	90	120	120	4	1	—	6	—	60.9	362	3 600	TP90120	—	W90120F	WS90120F	115	95.4	92	—	39	234
100	100	135	135	4	1	—	6	—	76.3	503	3 400	TP100135	—	W100135F	WS100135F	130	106.4	122	—	51	304

[Note] 1) In JIS, it is called a thrust washer or washer.

Koyo®

Track rollers



NEEDLE
ROLLER
BEARINGS

Stud type track rollers (cam followers)

The Koyo stud type track rollers are stud bearings with needle rollers built into a thick section outer ring. They are available in various types, such as caged and sealed types, according to various applications.

- The full complement type is suited for low speed, heavy load and impact load, while the caged type is generally used for medium speed and heavy load.
- Since the stud is provided with a screw, it can be easily fitted to the machine with a nut.

1 Bearing number

(Ex. 1) Metric series

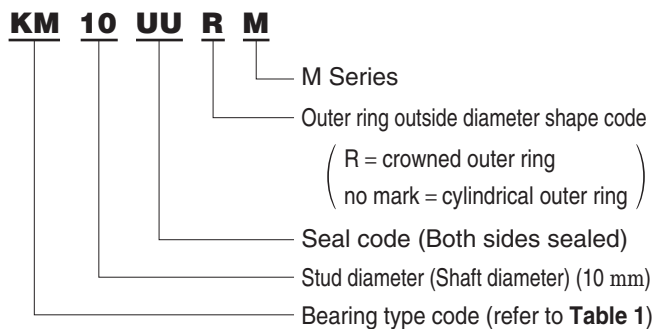

(Ex. 2) Inch series

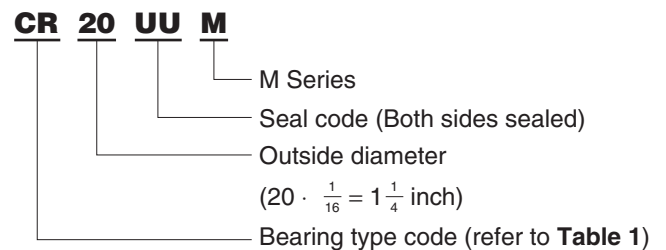

Table 1 Type code of stud type track rollers (cam followers)

Type		Full complement type		Caged Type	
		Without seals	With seals	Without seals	With seals
Metric series	Cylindrical outer ring	CM...M	CM...UUM	KM...M	KM...UUM
	Crowned outer ring	CM...RM	CM...UURM	KM...RM	KM...UURM
Inch series	Cylindrical outer ring	CR...M	CR...UUM	—	—

2 Tolerances

The Koyo stud type track rollers are manufactured according to the dimensional tolerances (JIS B 1536-5) shown in **Table 2**.

Table 2 Outer ring tolerance
(1) Metric series

Unit : μm

Nominal outside diameter D (mm)		Single plane mean outside diameter deviation Δ_{Dmp}				Single outer ring width deviation Δ_{Cs}		Radial runout of assembled bearing outer ring K_{ea}
		Cylindrical outside surface		Crowning outside surface				
over	up to	upper	lower	upper	lower	upper	lower	max.
10	18	0	- 8	0	-50	0	-120	15
18	30	0	- 9	0	-50	0	-120	15
30	50	0	-11	0	-50	0	-120	20
50	80	0	-13	0	-50	0	-120	25
80	120	0	-15	0	-50	0	-120	35

[Remark] Values in Italics are prescribed in JTEKT standards.

Table 2 Outer ring tolerance
(2) Inch series

Unit : μm

Nominal outside diameter D (mm)		Single plane mean outside diameter deviation Δ_{Dmp}				Single outer ring width deviation Δ_{Cs}		Radial runout of assembled bearing outer ring K_{ea}
		Cylindrical outside surface		Crowning outside surface				
over	up to	upper	lower	upper	lower	upper	lower	max.
—	57.15	<i>0</i>	<i>-25</i>	<i>0</i>	<i>-50</i>	<i>0</i>	<i>-127</i>	<i>25</i>

[Remark] Values in Italics are prescribed in JTEKT standards.

Table 3 Tolerances of shank diameter

(1) Metric series

Unit : μm

Shank diameter d_1 (mm)		Deviation of a single shank diameter Δ_{d1s}	
over	up to	upper	lower
3	6	0	-12
6	10	0	-15
10	18	0	-18
18	30	0	-21

(2) Inch series

Unit : μm

Shank diameter d_1 (mm)		Deviation of a single shank diameter Δ_{d1s}	
over	up to	upper	lower
—	22.225	<i>+25</i>	<i>0</i>

[Remark] Values in Italics are prescribed in JTEKT standards.

Table 4 Tolerances of shank length

Unit : μm

Shank length B_2 (mm)	Deviation of a single shank length Δ_{B2s}	
	upper	lower
Total dimensions	<i>+0.8</i>	<i>-0.8</i>

[Remark] Values in Italics are prescribed in JTEKT standards.

3 Fits

As the Koyo stud type track roller is used as a cantilever, it should be mounted with snug fit between the stud and the fitting bore. The recommended tolerance for the stud fitting bore is shown in **Table 5**.

Table 5 Tolerances for stud fitting bore

Bearing type	Tolerance class
CM, KM	H7
CR	F7

4 Lubrication

- 1) The Koyo stud type track roller with seal is filled with grease. It is high quality lithium soap base grease which can be used in a temperature range of $-10\text{ }^\circ\text{C}$ to $+100\text{ }^\circ\text{C}$.
- 2) The bearing without seal can be lubricated by feeding the lubricant into the lubrication holes located on both ends of the stud and into cross drilled hole of the stud.
- 3) The grease nipple can be fitted into the hole on the end of the stud; and the other hole not used should be closed with the attached plug.
The cross drilled hole of the stud is automatically closed when the stud is fitted in place.

- 4) When feeding the lubricant into the cross drilled hole located on the outside diameter of the stud, it is necessary to close the holes on both ends of the stud with the plugs.
- 5) Either grease or oil can be used as a lubricant. Oil is generally for high speed operation.

5 Accessories

Metric series ... Grease nipple, plug, hexagon nut
Inch series ... Plug, hexagon nut

Table 6 Dimensions of standard grease nipple (Metric series)

Unit : mm

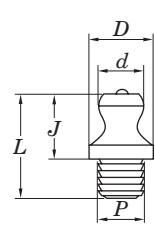

Applicable Bearing No.	P	d	D	J	L
KM6M to KM10-1M CM6M to CM10-1M	4	6.6	8	9	13
KM12M to KM18M CM12M to CM18M	6	6.6	8	9	14
KM20M to KM30-2M CM20M to CM30-2M	8	6.6	10	10.5	18

6 Mounting Instruction

- 1) The lubrication hole in the stud should be free from the load.
- 2) The lubrication hole position should be square with driver groove. (refer to Fig. 1)
- 3) The shoulder holding the end plate should be at least the same size as "F" in the specification table.
- 4) The end plate should be firmly backed up by the flat housing shoulder, which is square with stud center line.

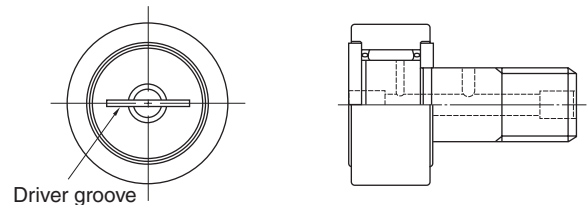

Fig. 1

7 Special Specifications

Stud type track roller with Hexagonal Hole

- 1) A hexagonal hole is provided instead of a driver groove.
- 2) Can be used with metric stud type track roller
- 3) Identified by their bearing no., which contains an H. Ex. KM6HM

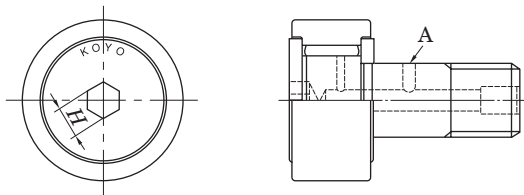

Table 7 Width across flat (H) of hexagonal hole

Stud Dia. (mm)	H (mm)	Stud Dia. (mm)	H (mm)
6	4	18	8
8	4	20	10
10	5	24	14
12	6	30	14
16	8		

[Note] The position of lubricating hole (A) is at top of stud when "Koyo" mark on stud type track roller is at twelve o'clock position. (refer to Fig. at left.)

8 Track capacity

Track capacity is the maximum load receivable without deformation or indentation of track surfaces contacted by the outer rings of track rollers to allow the track to be used continuously. The values in the specification table are track capacities obtained using track rollers with cylindrical outside surfaces made of HRC 40 steel.

Track capacity of the type track rollers with crowned outside surface is 80 % of the values listed in the specification table.

To obtain track capacity for hardness out of standard, multiply the track capacities by track capacity coefficient listed in the table at right.

Table 8 Track capacity

Hardness (HRC)	Track capacity coefficient
26	0.48
32	0.64
36	0.79
40	1
44	1.31
47	1.59
50	1.99
53	2.43
56	2.90
58	3.23

Stud type track rollers (cam followers)

CM (metric series, full complement type)

D 16 ~ 90 mm

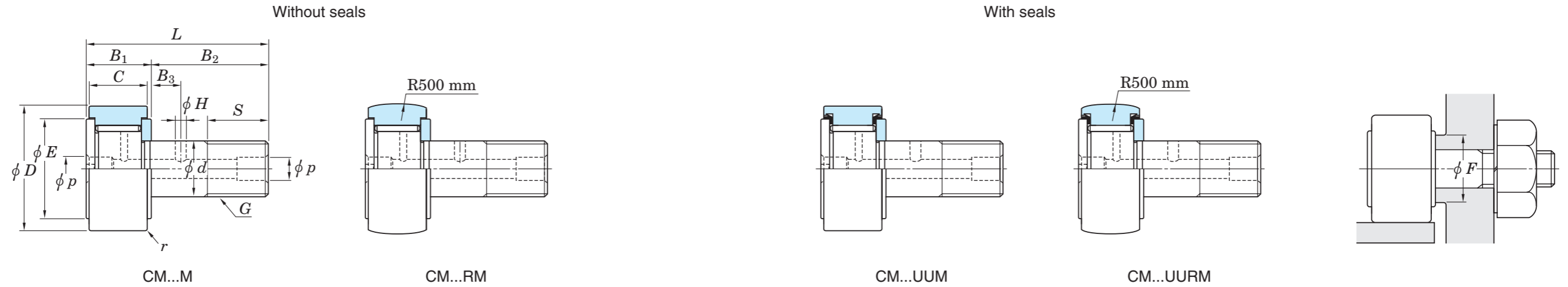

Outer ring	Boundary dimensions (mm)									Bearing No.			Clamping dia. F (mm)	Track roller load ratings ²⁾		JIS Basic load ratings ³⁾		Track capacity ⁴⁾ (kN)	Limiting speeds ⁵⁾ (min ⁻¹)		Tightening torque ⁶⁾ (N·m) max.	(Refer.) Mass (CM...M type) (kg)				
	D	C	r _{min.}	d	L	B ₁	B ₂	E	G	S	B ₃	H		p	Cylindrical outer ring	Crowned outer ring	C _t (kN)		P _{max} (kN)	C _r (kN)			C _{Or} (kN)	Grease lub.	Oil lub.	
16	11	0.3	6	28	12	16	12	M6×1	9	—	—	4 ¹⁾	CM6M	CM6RM	CM6UUM	CM6UURM	10.5	5.85	2.25	7.00	8.25	3.55	9 200	13 000	3.0	0.019
19	11	0.3	8	32	12	20	15	M8×1.25	11	—	—	4 ¹⁾	CM8M	CM8RM	CM8UUM	CM8UURM	12.5	6.70	5.20	8.05	10.4	4.25	8 200	12 000	7.3	0.029
22	12	0.5	10	36	13	23	17	M10×1.25	13	—	—	4	CM10M	CM10RM	CM10UUM	CM10UURM	15	7.80	9.30	9.35	12.3	5.20	7 200	10 000	15	0.044
26	12	0.5	10	36	13	23	17	M10×1.25	13	—	—	4	CM10-1M	CM10-1RM	CM10-1UUM	CM10-1UURM	15	7.80	9.30	9.35	12.3	6.15	7 200	10 000	15	0.056
30	14	1	12	40	15	25	22	M12×1.5	14	6	3	6	CM12M	CM12RM	CM12UUM	CM12UURM	19	11.0	13.9	13.2	18.0	7.75	5 900	8 300	26	0.089
32	14	1	12	40	15	25	22	M12×1.5	14	6	3	6	CM12-1M	CM12-1RM	CM12-1UUM	CM12-1UURM	19	11.0	13.9	13.2	18.0	8.25	5 900	8 300	26	0.099
35	18	1	16	52	19.5	32.5	27	M16×1.5	18	8	3	6	CM16M	CM16RM	CM16UUM	CM16UURM	24	16.8	25.7	20.2	33.9	12.0	4 600	6 400	64	0.171
40	20	1.5	18	58	21.5	36.5	32	M18×1.5	20	8	3	6	CM18M	CM18RM	CM18UUM	CM18UURM	27	19.2	31.9	23.1	38.2	14.6	4 000	5 700	92	0.248
47	24	1.5	20	66	25.5	40.5	36	M20×1.5	22	9	4	8	CM20M	CM20RM	CM20UUM	CM20UURM	30.5	25.6	39.1	30.7	57.2	21.2	3 600	5 000	130	0.393
52	24	1.5	20	66	25.5	40.5	36	M20×1.5	22	9	4	8	CM20-1M	CM20-1RM	CM20-1UUM	CM20-1UURM	30.5	25.6	39.1	30.7	57.2	23.5	3 600	5 000	130	0.455
62	29	1.5	24	80	30.5	49.5	44	M24×1.5	25	11	4	8	CM24M	CM24RM	CM24UUM	CM24UURM	37.5	38.8	55.7	46.5	92.0	34.6	2 900	4 100	220	0.810
72	29	2	24	80	30.5	49.5	44	M24×1.5	25	11	4	8	CM24-1M	CM24-1RM	CM24-1UUM	CM24-1UURM	37.5	38.8	55.7	46.5	92.0	38.7	2 900	4 100	220	1.05
80	35	2	30	100	37	63	58	M30×1.5	32	15	4	8	CM30M	CM30RM	CM30UUM	CM30UURM	51	64.0	95.2	76.8	159	53.3	2 100	3 000	440	1.64
85	35	2	30	100	37	63	58	M30×1.5	32	15	4	8	CM30-1M	CM30-1RM	CM30-1UUM	CM30-1UURM	51	64.0	95.2	76.8	159	56.6	2 100	3 000	440	1.81
90	35	2	30	100	37	63	58	M30×1.5	32	15	4	8	CM30-2M	CM30-2RM	CM30-2UUM	CM30-2UURM	51	64.0	95.2	76.8	159	60.0	2 100	3 000	440	2.00

[Notes] 1) Stud type track rollers with no lubrication hole on the stud threaded end.
 2) To calculate track roller rated service life, use these track roller load rating values (C_t). Numerical values P_{max} refer to maximum load track roller can accommodate. If track roller is fixed in housing as with regular type bearings, JIS basic static load rating values (C_{0r}) may apply.
 3) If track roller is fixed in housing, as with regular type bearings, rated service life can be calculated using JIS basic dynamic load rating values (C_r).

4) Track capacity is described in Table 8 on page 161. The values listed in the table are the capacities of cylindrical track rollers.
 5) Limiting speeds are applicable to without seals type.
 6) Tightening torque apply when threaded portion is dry; if thread is wet with oil or other fluid, torque is half these values.

Stud type track rollers (cam followers)

CR (inch series, full complement type)

D 12.700 ~ 50.800 mm

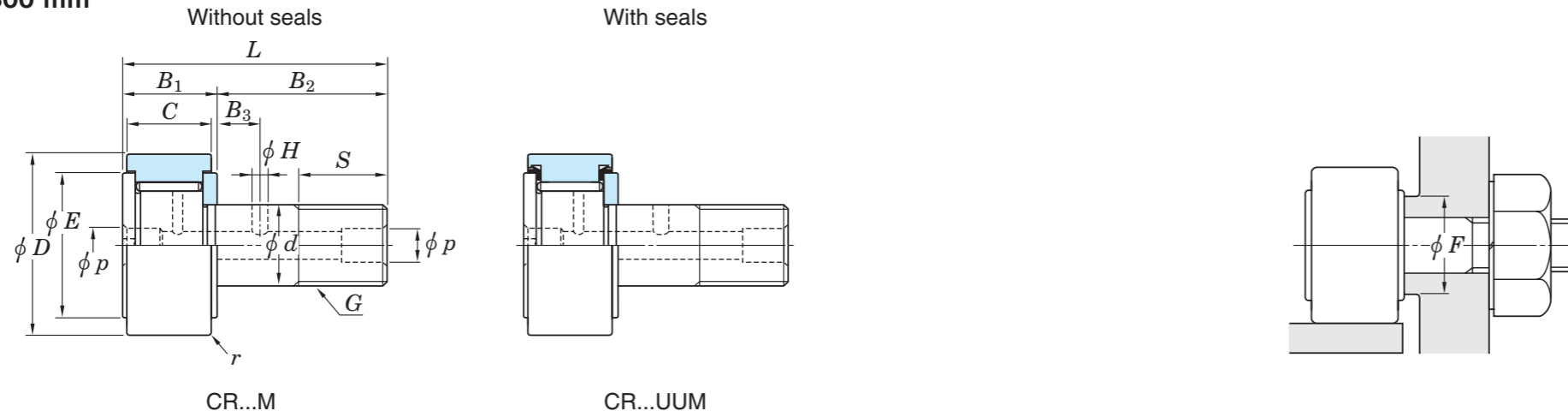

Outer ring D mm	Boundary dimensions (mm)									Thread G	Lubrication hole			Bearing No.	Clamping dia. F (mm)	Track roller load ratings ²⁾		JIS Basic load ratings ³⁾		Track capacity ⁴⁾ (kN)	Limiting speeds ⁵⁾ (min ⁻¹)		Tightening torque ⁶⁾ (N·m) max.	(Refer.) Mass (CR...M type) (kg)
	1/25.4	C	r min.	d mm	1/25.4	L	B ₁	B ₂	E		S	B ₃	H			p	Without seals	With seals	C _t (kN)		P _{max} (kN)	C _r (kN)		
12.700	1/2	8.738	0.3	4.826	—	22.225	9.525	12.700	10.0	10×32	6.350	—	—	3.2 ¹⁾	9.1	3.55	1.50	4.25	4.60	2.20	10 000	14 000	1.6	0.016
	1/2	9.525	0.3	4.826	—	26.194	10.319	15.875	10.0	10×32	6.350	—	—	3.2 ¹⁾										
14.288	9/16	9.525	0.4	4.826	—	26.194	10.319	15.875	10.0	10×32	6.350	—	—	3.2 ¹⁾	9.1	4.00	1.40	4.80	5.40	2.65	10 000	14 000	1.6	0.019
15.875	5/8	10.312	0.4	6.350	1/4	26.987	11.112	15.875	11.5	1/4×28	7.938	—	—	3.2 ¹⁾	10.5	4.85	2.90	5.85	7.45	3.25	9 200	13 000	3.7	0.022
	5/8	11.113	0.4	6.350	1/4	30.956	11.906	19.050	11.5	1/4×28	7.938	—	—	3.2 ¹⁾										
17.463	11/16	11.113	0.4	6.350	—	30.956	11.906	19.050	11.5	1/4×28	7.938	—	—	3.2 ¹⁾	10.5	5.30	2.70	6.35	8.35	3.85	9 200	13 000	3.7	0.027
19.050	3/4	12.700	0.4	9.525	3/8	35.719	13.494	22.225	15.0	3/8×24	9.525	6.4	2.4	4.8	14.4	8.25	7.80	9.90	14.2	4.85	7 400	10 000	13	0.032
22.225	7/8	12.700	0.4	9.525	3/8	35.719	13.494	22.225	15.0	3/8×24	9.525	6.4	2.4	4.8	14.4	8.25	7.80	9.90	14.2	5.70	7 400	10 000	13	0.041
25.400	1	15.875	0.8	11.112	7/16	42.069	16.669	25.400	19.5	7/16×20	12.700	6.4	2.4	4.8	18.0	10.6	10.0	12.7	21.3	7.80	6 100	8 500	21	0.077
28.575	1 1/8	15.875	0.8	11.112	7/16	42.069	16.669	25.400	19.5	7/16×20	12.700	6.4	2.4	4.8	18.0	10.6	10.0	12.7	21.3	8.75	6 100	8 500	21	0.086
31.750	1 1/4	19.050	1.2	12.700	1/2	51.594	19.844	31.750	24.5	1/2×20	15.875	7.9	2.4	4.8	22.7	19.2	12.7	23.0	29.5	11.4	5 100	7 200	32	0.136
34.925	1 3/8	19.050	1.2	12.700	1/2	51.594	19.844	31.750	24.5	1/2×20	15.875	7.9	2.4	4.8	22.7	19.2	12.7	23.0	29.5	12.5	5 100	7 200	32	0.159
38.100	1 1/2	22.225	1.6	15.875	5/8	61.119	23.019	38.100	27.5	5/8×18	19.050	9.5	2.4	4.8	25.7	23.2	21.5	27.8	39.3	15.6	4 400	6 200	62	0.240
41.275	1 5/8	22.225	1.6	15.875	5/8	61.119	23.019	38.100	27.5	5/8×18	19.050	9.5	2.4	4.8	25.7	23.2	21.5	27.8	39.3	16.9	4 400	6 200	62	0.272
44.450	1 3/4	25.400	1.6	19.050	3/4	70.644	26.194	44.450	31.5	3/4×16	22.225	11.1	2.4	4.8	28.8	29.2	32.9	35.0	55.3	21.2	3 900	5 500	110	0.381
47.625	1 7/8	25.400	1.6	19.050	3/4	70.644	26.194	44.450	31.5	3/4×16	22.225	11.1	2.4	4.8	28.8	29.2	32.9	35.0	55.3	22.7	3 900	5 500	110	0.431
50.800	2	31.750	2.4	22.225	7/8	83.344	32.544	50.800	35.5	7/8×14	25.400	12.7	3.2	4.8	31.8	35.5	42.8	42.6	74.0	29.4	3 500	4 900	170	0.617

[Notes] 1) Stud type track rollers with no lubrication hole on the stud threaded end.
 2) To calculate track roller rated service life, use these track roller load rating values (C_t). Numerical values P_{max} refer to maximum load track roller can accommodate. If track roller is fixed in housing as with regular type bearings, JIS basic static load rating values (C_{0r}) may apply.
 3) If track roller is fixed in housing, as with regular type bearings, rated service life can be calculated using JIS basic dynamic load rating values (C_r).

4) Track capacity is described in Table 8 on page 161. The values listed in the table are the capacities of cylindrical track rollers.
 5) Limiting speeds are applicable to without seals type.
 6) Tightening torque apply when threaded portion is dry; if thread is wet with oil or other fluid, torque is half these values.

Stud type track rollers (cam followers)

CR (inch series, full complement type)

D 57.150 mm

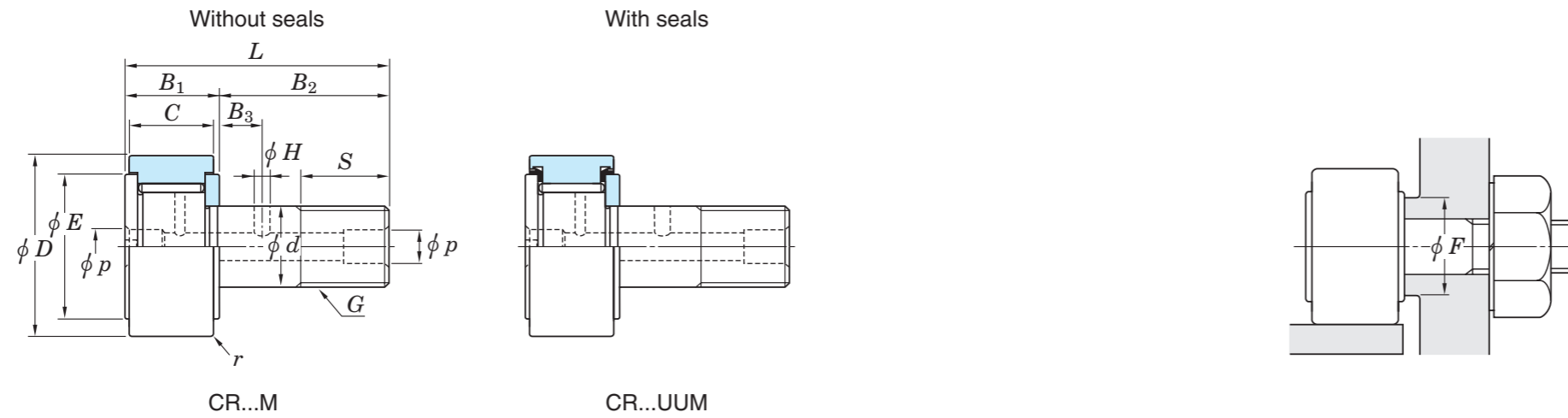

Outer ring		Boundary dimensions (mm)										Bearing No.		Clamping dia. F (mm)	Track roller load ratings ²⁾		JIS Basic load ratings ³⁾		Track capacity ⁴⁾ (kN)	Limiting speeds ⁵⁾ (min ⁻¹)		Tightening torque ⁶⁾ (N·m) max.	(Refer.) Mass (CR...M type) (kg)			
D mm	C	r min.	d mm	L	B_1	B_2	E	G	S	B_3	H	p	Without seals		With seals	C_t (kN)	P_{max} (kN)	C_r (kN)		C_{Or} (kN)	Grease lub.			Oil lub.		
57.150	2 1/4	31.750	2.4	22.225	7/8	83.344	32.544	50.800	35.5	7/8 x 14	25.400	12.7	3.2	4.8	CR36M	CR36UUM	31.8	35.5	42.8	42.6	74.0	33.1	3 500	4 900	170	0.748

- [Notes]
- 1) Stud type track rollers with no lubrication hole on the stud threaded end.
 - 2) To calculate track roller rated service life, use these track roller load rating values (C_t). Numerical values P_{max} refer to maximum load track roller can accommodate. If track roller is fixed in housing as with regular type bearings, JIS basic static load rating values (C_{Or}) may apply.
 - 3) If track roller is fixed in housing, as with regular type bearings, rated service life can be calculated using JIS basic dynamic load rating values (C_r).

- 4) Track capacity is described in Table 8 on page 161. The values listed in the table are the capacities of cylindrical track rollers.
- 5) Limiting speeds are applicable to without seals type.
- 6) Tightening torque apply when threaded portion is dry; if thread is wet with oil or other fluid, torque is half these values.

Stud type track rollers (cam followers)

KM (metric series, caged type)

D 13 ~ 90 mm

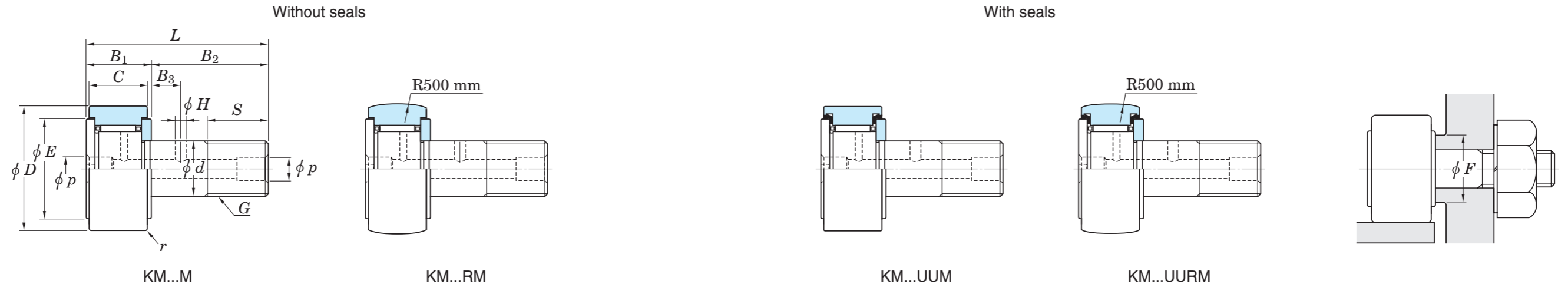

Outer ring	Boundary dimensions (mm)										Bearing No.		Clamping dia. F (mm)	Track roller load ratings ²⁾		JIS Basic load ratings ³⁾		Track capacity ⁴⁾ (kN)	Limiting speeds ⁵⁾ (min ⁻¹)		Tightening torque ⁶⁾ (N·m) max.	(Refer.) Mass (kg)				
	D	C	r _{min.}	d	L	B ₁	B ₂	E	G	S	B ₃	H		p	Cylindrical outer ring	Crowned outer ring	C _t (kN)		P _{max} (kN)	C _r (kN)			C _{0r} (kN)	Grease lub.	Oil lub.	
13	9	0.3	5	23	10	13	10	M5×0.8	7.5	—	—	3 ¹⁾	KM5M	KM5RM	KM5UUM	KM5UURM	9.0	2.20	1.60	2.65	2.45	2.35	16 000	22 000	1.8	0.010
16	11	0.3	6	28	12	16	12	M6×1	9	—	—	4 ¹⁾	KM6M	KM6RM	KM6UUM	KM6UURM	10.5	3.40	2.25	4.10	4.05	3.55	15 000	20 000	3.0	0.018
19	11	0.3	8	32	12	20	15	M8×1.25	11	—	—	4 ¹⁾	KM8M	KM8RM	KM8UUM	KM8UURM	12.5	3.80	4.10	4.55	4.90	4.25	13 000	18 000	7.3	0.028
22	12	0.5	10	36	13	23	17	M10×1.25	13	—	—	4	KM10M	KM10RM	KM10UUM	KM10UURM	15	5.20	6.05	6.25	7.25	5.20	11 000	16 000	15	0.043
26	12	0.5	10	36	13	23	17	M10×1.25	13	—	—	4	KM10-1M	KM10-1RM	KM10-1UUM	KM10-1UURM	15	5.20	6.05	6.25	7.25	6.15	11 000	16 000	15	0.055
30	14	1	12	40	15	25	22	M12×1.5	14	6	3	6	KM12M	KM12RM	KM12UUM	KM12UURM	19	6.80	8.00	8.20	9.60	7.75	9 500	13 000	26	0.087
32	14	1	12	40	15	25	22	M12×1.5	14	6	3	6	KM12-1M	KM12-1RM	KM12-1UUM	KM12-1UURM	19	6.80	8.00	8.20	9.60	8.25	9 500	13 000	26	0.096
35	18	1	16	52	19.5	32.5	27	M16×1.5	18	8	3	6	KM16M	KM16RM	KM16UUM	KM16UURM	24	10.8	15.8	13.0	18.9	12.0	7 400	10 000	64	0.166
40	20	1.5	18	58	21.5	36.5	32	M18×1.5	20	8	3	6	KM18M	KM18RM	KM18UUM	KM18UURM	27	13.3	19.6	15.9	23.5	14.6	6 500	8 900	92	0.245
47	24	1.5	20	66	25.5	40.5	36	M20×1.5	22	9	4	8	KM20M	KM20RM	KM20UUM	KM20UURM	30.5	17.7	29.5	21.3	35.4	21.2	5 700	7 900	130	0.387
52	24	1.5	20	66	25.5	40.5	36	M20×1.5	22	9	4	8	KM20-1M	KM20-1RM	KM20-1UUM	KM20-1UURM	30.5	17.7	29.5	21.3	35.4	23.5	5 700	7 900	130	0.453
62	29	1.5	24	80	30.5	49.5	44	M24×1.5	25	11	4	8	KM24M	KM24RM	KM24UUM	KM24UURM	37.5	26.3	46.1	31.6	55.3	34.6	4 600	6 400	220	0.801
72	29	2	24	80	30.5	49.5	44	M24×1.5	25	11	4	8	KM24-1M	KM24-1RM	KM24-1UUM	KM24-1UURM	37.5	26.3	46.1	31.6	55.3	38.7	4 600	6 400	220	1.04
80	35	2	30	100	37	63	58	M30×1.5	32	15	4	8	KM30M	KM30RM	KM30UUM	KM30UURM	51	46.5	86.9	55.8	104	53.3	3 400	4 700	440	1.62
85	35	2	30	100	37	63	58	M30×1.5	32	15	4	8	KM30-1M	KM30-1RM	KM30-1UUM	KM30-1UURM	51	46.5	86.9	55.8	104	56.6	3 400	4 700	440	1.79
90	35	2	30	100	37	63	58	M30×1.5	32	15	4	8	KM30-2M	KM30-2RM	KM30-2UUM	KM30-2UURM	51	46.5	86.9	55.8	104	60.0	3 400	4 700	440	1.98

[Notes] 1) Stud type track rollers with no lubrication hole on the stud threaded end.
 2) To calculate track roller rated service life, use these track roller load rating values (C_t). Numerical values P_{max} refer to maximum load track roller can accommodate. If track roller is fixed in housing as with regular type bearings, JIS basic static load rating values (C_{0r}) may apply.
 3) If track roller is fixed in housing, as with regular type bearings, rated service life can be calculated using JIS basic dynamic load rating values (C_r).

4) Track capacity is described in Table 8 on page 161. The values listed in the table are the capacities of cylindrical track rollers.
 5) Limiting speeds are applicable to without seals type.
 6) Tightening torque apply when threaded portion is dry; if thread is wet with oil or other fluid, torque is half these values.

Yoke type track rollers (roller followers)

The Koyo yoke type track rollers are non-separable bearings with needle rollers built into a thick section outer ring.

Many types such as full complement, with cage and with seal can be used according to various needs.

■ The full complement type is suited for low speed, heavy load and impact load, while the caged type is generally used for medium speed and heavy load.

1 Bearing number

(Ex.)

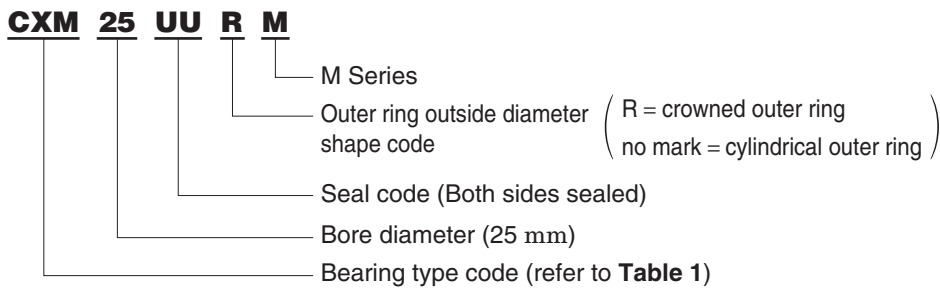

Table 1 Type code of yoke type track rollers (roller followers)

Type	Full complement type		Caged type	
	Without seals	With seals	Without seals	With seals
Cylindrical outer ring	CYM...M	CYM...UUM	CXM...M	CXM...UUM
Crowned outer ring	CYM...RM	CYM...UURM	CXM...RM	CXM...UURM

2 Tolerances

The Koyo yoke type track rollers are manufactured according to the tolerances shown in **Table 2**.

Table 2 Tolerances for metric series = JIS B 1536-5 =

(1) Inner ring

Unit : μm

Nominal bore diameter d (mm)		Single plane mean bore diameter deviation Δ_{dmp}		Single inner ring width deviation Δ_{Bs}	
over	up to	upper	lower	upper	lower
2.5	10	0	-8	0	-180
10	18	0	-8	0	-210
18	30	0	-10	0	-210
30	50	0	-12	0	-250

[Remark] Values in Italics are prescribed in JTEKT standards.

(2) Outer ring

Unit : μm

Nominal outside diameter D (mm)		Single plane mean outside diameter deviation Δ_{Dmp}				Single outer ring width deviation Δ_{Cs}		Radial runout of assembled bearing outer ring K_{ea}
over	up to	Cylindrical outside surface		Crowning outside surface		upper	lower	
over	up to	upper	lower	upper	lower	upper	lower	max.
10	18	0	-8	0	-50	0	-120	15
18	30	0	-9	0	-50	0	-120	15
30	50	0	-11	0	-50	0	-120	20
50	80	0	-13	0	-50	0	-120	25
80	120	0	-15	0	-50	0	-120	35

[Remark] Values in Italics are prescribed in JTEKT standards.

3 Fits

Because Koyo yoke type track rollers (roller followers) are generally used with the outer ring rotation, they should be attached to the shaft by transition fitting or clearance fitting. If the application involves heavy loading, the shaft should be hardened and the track roller should be attached by interference fitting. The tolerance for the shaft is shown in **Table 3**.

Table 3 Shaft tolerance

Degree of loading	Shaft tolerance class
Light or medium load	g6 or h6
Heavy load	k6

4 Lubrication

- 1) The Koyo yoke type track roller with seal filled with grease. It is high quality lithium soap base grease which can be used in a temperature range of $-10\text{ }^{\circ}\text{C}$ to $+100\text{ }^{\circ}\text{C}$.
- 2) The Koyo yoke type track roller without seal is not filled with grease, so it is necessary to supply grease or lubricating oil when in use.
- 3) Either grease and oil can be used as a lubricant. Generally, oil is used for high speed operation.

5 Track capacity

Track capacity is the maximum load receivable without deformation or indentation of track surfaces contacted by the outer rings of track rollers to allow the track to be used continuously. The values in the specification table are track capacities obtained using track rollers with cylindrical outside surfaces made of HRC 40 steel.

Track capacity of the type track rollers with spherical outside surface is 80 % of the values listed in the specification table.

To obtain track capacity for hardness out of standard, multiply the track capacities by track capacity coefficient listed in the table at right.

Mounting Instruction

- 1) When the Koyo yoke type track roller is used under heavy loading, the lubrication hole should be located in the no-load zone.
- 2) In order to prevent axial movement of the bearing, the inner ring should be clamped end wise. To support the end plate securely, it is preferable to make the shoulder size larger than "E" shown in the specification table.

Table 4 Track capacity

Hardness (HRC)	Track capacity coefficient
26	0.48
32	0.64
36	0.79
40	1
44	1.31
47	1.59
50	1.99
53	2.43
56	2.90
58	3.23

Yoke type track rollers (roller followers)

CYM (full complement type)

d 5 ~ 50 mm

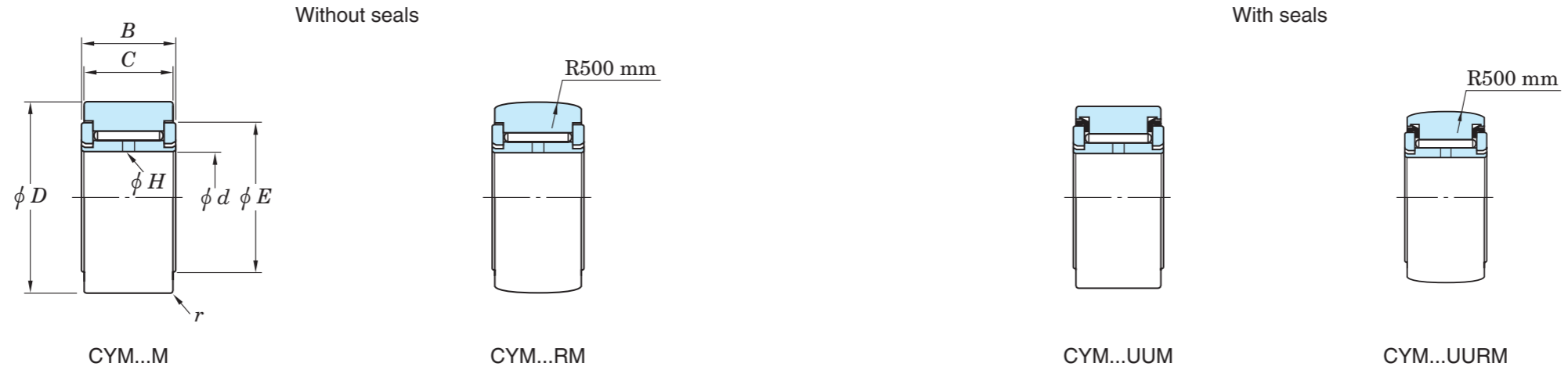

Boundary dimensions (mm)							Bearing No.				Track roller load ratings ²⁾		JIS Basic load ratings ³⁾		Track capacity ⁴⁾	Limiting speeds ⁵⁾ (min ⁻¹)		(Refer.) Mass (CYM...M type) (kg)
d	D	B	C	r min.	E	H ¹⁾	Without seals Cylindrical outer ring	Without seals Crowned outer ring	With seals Cylindrical outer ring	With seals Crowned outer ring	C _t (kN)	P _{max} (kN)	C _r (kN)	C _{0r} (kN)	(kN)	Grease lub.	Oil lub.	
5	16	12	11	0.3	12	2	CYM5M	CYM5RM	CYM5UUM	CYM5UURM	5.85	6.85	7.00	8.25	3.55	9 200	13 000	0.014
6	19	12	11	0.3	15	2	CYM6M	CYM6RM	CYM6UUM	CYM6UURM	6.70	8.70	8.05	10.4	4.25	8 200	12 000	0.021
8	24	15	14	0.5	18	2	CYM8M	CYM8RM	CYM8UUM	CYM8UURM	9.55	12.6	11.5	15.1	6.70	6 800	9 500	0.043
10	30	15	14	1	22	2	CYM10M	CYM10RM	CYM10UUM	CYM10UURM	11.1	15.1	13.3	18.1	7.75	5 900	8 300	0.062
12	32	15	14	1	24	2	CYM12M	CYM12RM	CYM12UUM	CYM12UURM	11.9	17.3	14.3	20.7	8.25	5 300	7 400	0.069
15	35	19	18	1	27	2	CYM15M	CYM15RM	CYM15UUM	CYM15UURM	16.8	28.2	20.2	33.9	12.0	4 600	6 400	0.105
17	40	21	20	1.5	32	2.4	CYM17M	CYM17RM	CYM17UUM	CYM17UURM	19.2	31.8	23.1	38.2	14.6	4 000	5 700	0.153
20	47	25	24	1.5	36	2.4	CYM20M	CYM20RM	CYM20UUM	CYM20UURM	25.6	47.7	30.7	57.3	21.2	3 600	5 000	0.255
25	52	25	24	1.5	41	2.4	CYM25M	CYM25RM	CYM25UUM	CYM25UURM	28.4	58.2	34.1	69.8	23.5	3 000	4 200	0.284
30	62	29	28	1.5	51	3.2	CYM30M	CYM30RM	CYM30UUM	CYM30UURM	41.5	88.8	49.8	107	33.3	2 400	3 400	0.476
35	72	29	28	2	58	3.2	CYM35M	CYM35RM	CYM35UUM	CYM35UURM	47.4	99.4	56.9	119	37.1	2 100	2 900	0.649
40	80	32	30	2	63	3.2	CYM40M	CYM40RM	CYM40UUM	CYM40UURM	58.3	122	70.0	147	44.7	1 900	2 600	0.845
45	85	32	30	2	69	3.2	CYM45M	CYM45RM	CYM45UUM	CYM45UURM	61.4	135	73.7	162	47.5	1 700	2 400	0.924
50	90	32	30	2	75	3.2	CYM50M	CYM50RM	CYM50UUM	CYM50UURM	64.2	148	77.0	177	50.3	1 600	2 200	0.984

[Notes] 1) Lubrication hole is provided on inner ring internal surface.
 2) To calculate track roller rated service life, use these track roller load rating values (C_t). Numerical values P_{max} refer to maximum load track roller can accommodate. If track roller is fixed in housing as with regular type bearings, JIS basic static load rating values (C_{0r}) may apply.
 3) If track roller is fixed in housing, as with regular type bearings, rated service life can be calculated using JIS basic dynamic load rating values (C_r).

4) Track capacity is described in Table 4 on page 171. The values listed in the above table are the capacities of cylindrical track rollers. The track capacities of crowned track rollers are 80 % of these values.
 5) Limiting speeds are as measured with no seals.

Yoke type track rollers (roller followers)

CXM (caged type)

d 5 ~ 50 mm

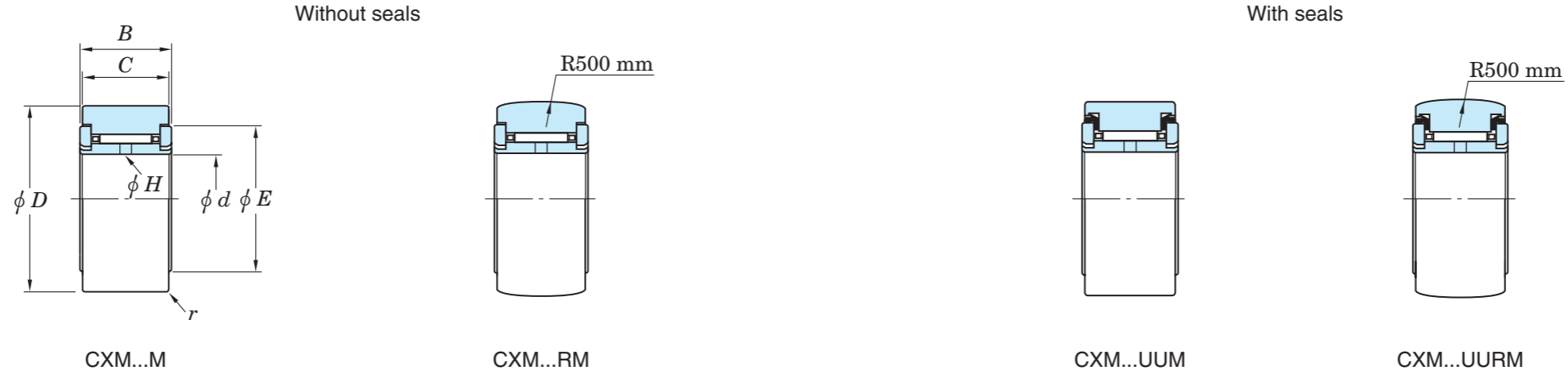

Boundary dimensions (mm)							Bearing No.				Track roller load ratings ²⁾		JIS Basic load ratings ³⁾		Track capacity ⁴⁾	Limiting speeds ⁵⁾ (min ⁻¹)		(Refer.) Mass (kg)
d	D	B	C	$r_{min.}$	E	$H^{1)}$	Without seals	Without seals	With seals	With seals	C_t (kN)	P_{max} (kN)	C_r (kN)	C_{Or} (kN)	(kN)	Grease lub.	Oil lub.	(CXM...M type)
							Cylindrical outer ring	Crowned outer ring	Cylindrical outer ring	Crowned outer ring								
5	16	12	11	0.3	12	2	CXM5M	CXM5RM	CXM5UUM	CXM5UURM	3.40	3.40	4.10	4.05	3.55	15 000	20 000	0.011
6	19	12	11	0.3	15	2	CXM6M	CXM6RM	CXM6UUM	CXM6UURM	3.80	4.10	4.55	4.90	4.25	13 000	18 000	0.018
8	24	15	14	0.5	18	2	CXM8M	CXM8RM	CXM8UUM	CXM8UURM	5.70	6.40	6.85	7.65	6.70	11 000	15 000	0.040
10	30	15	14	1	22	2	CXM10M	CXM10RM	CXM10UUM	CXM10UURM	6.80	8.00	8.20	9.60	7.75	9 500	13 000	0.060
12	32	15	14	1	24	2	CXM12M	CXM12RM	CXM12UUM	CXM12UURM	7.25	9.05	8.70	10.8	8.25	8 400	12 000	0.067
15	35	19	18	1	27	2	CXM15M	CXM15RM	CXM15UUM	CXM15UURM	10.8	15.8	13.0	18.9	12.0	7 400	10 000	0.102
17	40	21	20	1.5	32	2.4	CXM17M	CXM17RM	CXM17UUM	CXM17UURM	13.3	19.6	15.9	23.5	14.6	6 500	8 900	0.150
20	47	25	24	1.5	36	2.4	CXM20M	CXM20RM	CXM20UUM	CXM20UURM	17.7	29.5	21.3	35.4	21.2	5 700	7 900	0.252
25	52	25	24	1.5	41	2.4	CXM25M	CXM25RM	CXM25UUM	CXM25UURM	19.2	34.6	23.0	41.5	23.5	4 800	6 600	0.278
30	62	29	28	1.5	51	3.2	CXM30M	CXM30RM	CXM30UUM	CXM30UURM	28.4	53.9	34.0	64.7	33.3	3 900	5 300	0.465
35	72	29	28	2	58	3.2	CXM35M	CXM35RM	CXM35UUM	CXM35UURM	32.4	60.3	38.9	72.4	37.1	3 300	4 600	0.636
40	80	32	30	2	63	3.2	CXM40M	CXM40RM	CXM40UUM	CXM40UURM	41.4	78.1	49.7	93.7	44.7	3 000	4 100	0.825
45	85	32	30	2	69	3.2	CXM45M	CXM45RM	CXM45UUM	CXM45UURM	42.7	83.6	51.2	100	47.5	2 700	3 700	0.901
50	90	32	30	2	75	3.2	CXM50M	CXM50RM	CXM50UUM	CXM50UURM	45.5	93.9	54.6	113	50.3	2 500	3 400	0.960

[Notes] 1) Lubrication hole is provided on inner ring internal surface.
 2) To calculate track roller rated service life, use these track roller load rating values (C_t). Numerical values P_{max} refer to maximum load track roller can accommodate. If track roller is fixed in housing as with regular type bearings, JIS basic static load rating values (C_{Or}) may apply.
 3) If track roller is fixed in housing, as with regular type bearings, rated service life can be calculated using JIS basic dynamic load rating values (C_r).

4) Track capacity is described in Table 4 on page 171. The values listed in the above table are the capacities of cylindrical track rollers. The track capacities of crowned track rollers are 80 % of these values.
 5) Limiting speeds are as measured with no seals.

Koyo®

Needle rollers

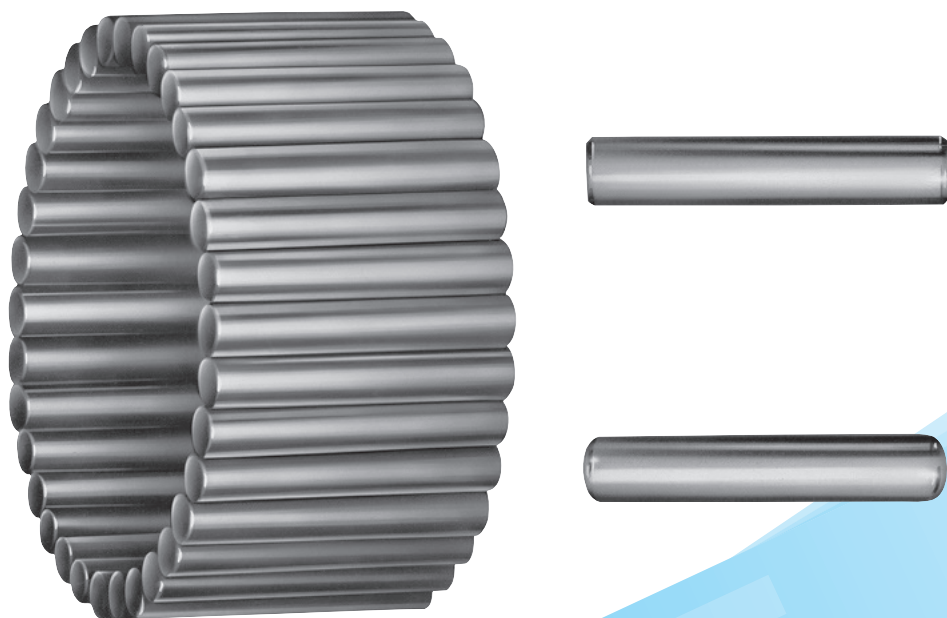

NEEDLE
ROLLER
BEARINGS

Needle rollers

Koyo needle rollers with proper end faces can be selected depending on varied operating conditions.

They are made of bearing steel, their hardness ranges from 60 to 66 HRC, and tolerances of class 3 conforming to JIS B 1506 roller for roller bearing are applied as the standard item.

When using the roller as full complements type, the circumferential clearance (Δc) must be 0.1 mm (minimum) under normal rotating condition.

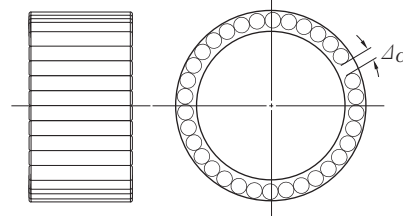

1 Roller number

(Ex.)

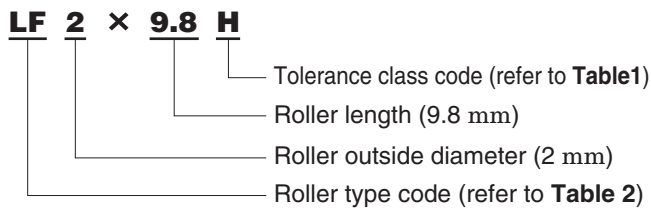

Table 1 Tolerance class code

Code	Description
No mark	Class 5
H	Class 3
P	Class 2

Table 2 Type code of rollers

End face	Name	Code		Remarks
		JIS	JTEKT	
	Flat end ¹⁾	F	LF	Obtains maximum effective contact length.
	Spherical end	A	LA	

[Note] 1) Roller end face center with grinding undercut is included.

2 Tolerances

The tolerances of Koyo needle roller are as specified in JIS B 1506.

Table 3 Tolerance grades and recommended gauge of needle rollers

Unit : μm

class	Single plane diameter variation ¹⁾ V_{Dwp} (max.)	Deviation from circular form ¹⁾ Δ_{Rw} (max.)	Gauge lot diameter variation ¹⁾ V_{DwL} (max.)	Actual length deviation ²⁾ Δ_{Lws}	Recommended gauge <i>S</i>
2	1	1	2	h13	0/-2, -1/-3, 2/-4, -3/-5, -4/-6, -5/-7, -6/-8, -7/-9, -8/-10
3	1.5	1.5	3		0/-3, -1.5/-4.5, -3/-6, -4.5/-7.5, -6/-9, -7/-10
5	2	2.5	5		0/-5, -3/-8, -5/-10

[Notes] 1) Values apply only at middle of roller length.

2) Applied tolerance differs according to L_w division.

[Remark] Along the entire length of the roller, all the actually measured diameters should not exceed the actual maximum diameter at the middle of the entire length of the roller by the lengths shown below.

a) class 2 : 0.5 μm b) class 3 : 0.8 μm c) class 5 : 1 μm

Needle rollers
 D_w 1.500 ~ (3.000) mm

 D_w (3.000) ~ (4.000) mm

 D_w (4.000) ~ (6.000) mm

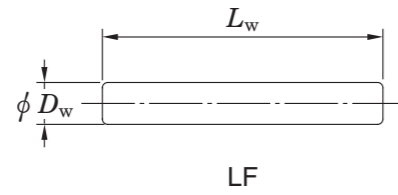
 D_w (6.000) mm

Dimensions (mm)		Roller No.	Mass (per 1 000 pcs.) (kg)
D_w	L_w		
1.500	5.8	1.5×5.8	0.076
1.500	6.8	1.5×6.8	0.090
1.500	7.8	1.5×7.8	0.102
1.500	9.8	1.5×9.8	0.131
1.500	11.8	1.5×11.8	0.157
1.500	13.8	1.5×13.8	0.185
<hr/>			
2.000	6.8	2×6.8	0.158
2.000	7.8	2×7.8	0.183
2.000	9.8	2×9.8	0.231
2.000	11.8	2×11.8	0.280
2.000	13.8	2×13.8	0.329
2.000	15.8	2×15.8	0.378
2.000	17.8	2×17.8	0.420
2.000	19.8	2×19.8	0.475
<hr/>			
2.500	7.8	2.5×7.8	0.283
2.500	9.8	2.5×9.8	0.359
2.500	11.8	2.5×11.8	0.435
2.500	13.8	2.5×13.8	0.511
2.500	15.8	2.5×15.8	0.587
2.500	17.8	2.5×17.8	0.663
2.500	19.8	2.5×19.8	0.739
2.500	21.8	2.5×21.8	0.815
2.500	23.8	2.5×23.8	0.891
<hr/>			
3.000	9.8	3×9.8	0.513
3.000	11.8	3×11.8	0.622
3.000	13.8	3×13.8	0.732
3.000	15.8	3×15.8	0.841
3.000	17.8	3×17.8	0.951
3.000	19.8	3×19.8	1.06

Dimensions (mm)		Roller No.	Mass (per 1 000 pcs.) (kg)
D_w	L_w		
3.000	21.8	3×21.8	1.17
3.000	23.8	3×23.8	1.28
3.000	25.8	3×25.8	1.38
3.000	27.8	3×27.8	1.50
3.000	29.8	3×29.8	1.61
<hr/>			
3.500	11.8	3.5×11.8	0.841
3.500	13.8	3.5×13.8	0.991
3.500	15.8	3.5×15.8	1.14
3.500	17.8	3.5×17.8	1.29
3.500	19.8	3.5×19.8	1.44
3.500	21.8	3.5×21.8	1.56
3.500	23.8	3.5×23.8	1.74
3.500	25.8	3.5×25.8	1.86
3.500	27.8	3.5×27.8	2.01
3.500	29.8	3.5×29.8	2.18
3.500	31.8	3.5×31.8	2.31
3.500	34.8	3.5×34.8	2.53
<hr/>			
4.000	11.8	4×11.8	1.15
4.000	13.8	4×13.8	1.29
4.000	15.8	4×15.8	1.48
4.000	17.8	4×17.8	1.68
4.000	19.8	4×19.8	1.87
4.000	21.8	4×21.8	2.07
4.000	23.8	4×23.8	2.26
4.000	25.8	4×25.8	2.42
4.000	27.8	4×27.8	2.65
4.000	29.8	4×29.8	2.85
4.000	31.8	4×31.8	3.04
4.000	34.8	4×34.8	3.30

Dimensions (mm)		Roller No.	Mass (per 1 000 pcs.) (kg)
D_w	L_w		
4.000	37.8	4×37.8	3.59
4.000	39.8	4×39.8	3.79
<hr/>			
4.500	17.8	4.5×17.8	2.07
4.500	19.8	4.5×19.8	2.31
4.500	21.8	4.5×21.8	2.56
4.500	23.8	4.5×23.8	2.81
4.500	25.8	4.5×25.8	3.05
4.500	29.8	4.5×29.8	3.55
4.500	31.8	4.5×31.8	3.76
4.500	34.8	4.5×34.8	4.21
4.500	37.8	4.5×37.8	4.53
4.500	39.8	4.5×39.8	4.78
4.500	44.8	4.5×44.8	5.40
<hr/>			
5.000	15.8	5×15.8	2.32
5.000	17.8	5×17.8	2.70
5.000	19.8	5×19.8	2.84
5.000	21.8	5×21.8	3.14
5.000	23.8	5×23.8	3.45
5.000	25.8	5×25.8	3.75
5.000	27.8	5×27.8	4.06
5.000	29.8	5×29.8	4.36
5.000	31.8	5×31.8	4.67
5.000	34.8	5×34.8	5.12
5.000	37.8	5×37.8	5.58
5.000	39.8	5×39.8	5.88
5.000	49.8	5×49.8	7.40
<hr/>			
6.000	17.8	6×17.8	3.90
6.000	19.8	6×19.8	4.33

Dimensions (mm)		Roller No.	Mass (per 1 000 pcs.) (kg)
D_w	L_w		
6.000	21.8	6×21.8	4.77
6.000	23.8	6×23.8	5.21
6.000	25.8	6×25.8	5.65
6.000	27.8	6×27.8	6.08
6.000	29.8	6×29.8	6.52
6.000	34.8	6×34.8	7.62
6.000	39.8	6×39.8	8.71
6.000	49.8	6×49.8	10.90
6.000	59.8	6×59.8	13.09

Other products · Example of use

Needle roller and cage assemblies for high-rotation speed planetary gears

Structure and characteristics

- M-shape cross section provides lightweight and high rigidity
- Bearing load capacity is increased by extended entire length of roller

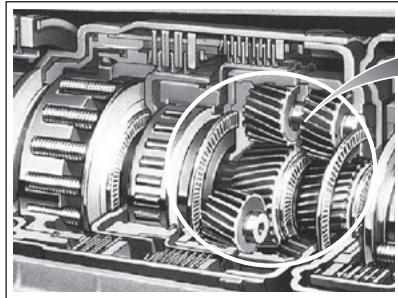

Automotive automatic transmission
(planetary gear unit)



Needle roller and cage assemblies

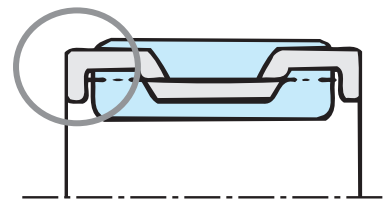
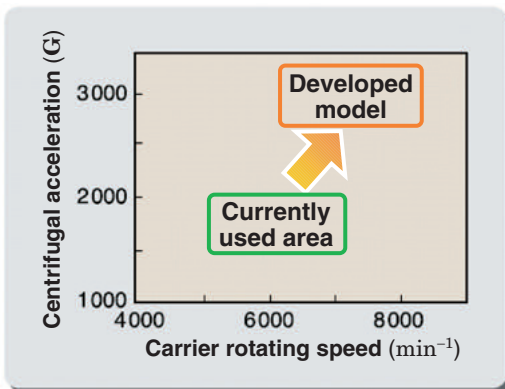

Sectional drawing

Advantages obtained by M-shape sectional

Lightweight and high rigidity

Cage weight	Decreased by 12%
Cage strength (FEM analysis)	Increased by 60%
Load capacity	Increased by 10%

Compared to current model

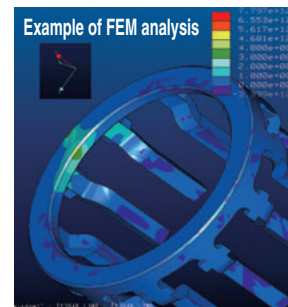

Low torque needle roller and cage thrust assemblies

Structure and characteristics

- Low torque (decreased by 50 % in every load area)
Used in automatic transmission or continuously variable transmission of automobiles or reduction gears of battery vehicles to contribute to improvement in fuel consumption



Contact point of roller end face and cage (contact near center of roller)

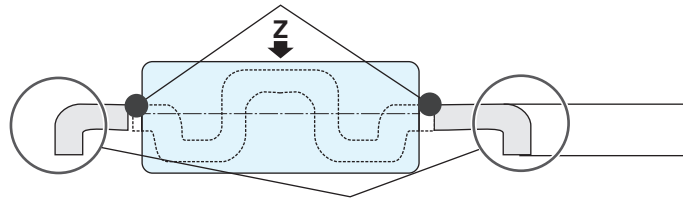

Increased rigidity for stability of contact of roller end face with cage

Contact point of roller end face and cage

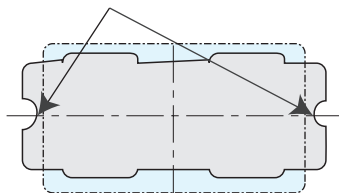

Cage pocket (view Z)

Contact point of roller end face and cage

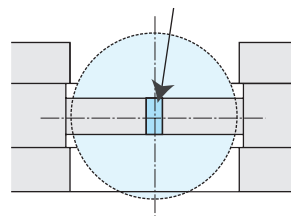

Cross section of pocket

Torque reduction

Amount of oil : 200 ml (Rotational speed : 2 000 min⁻¹)

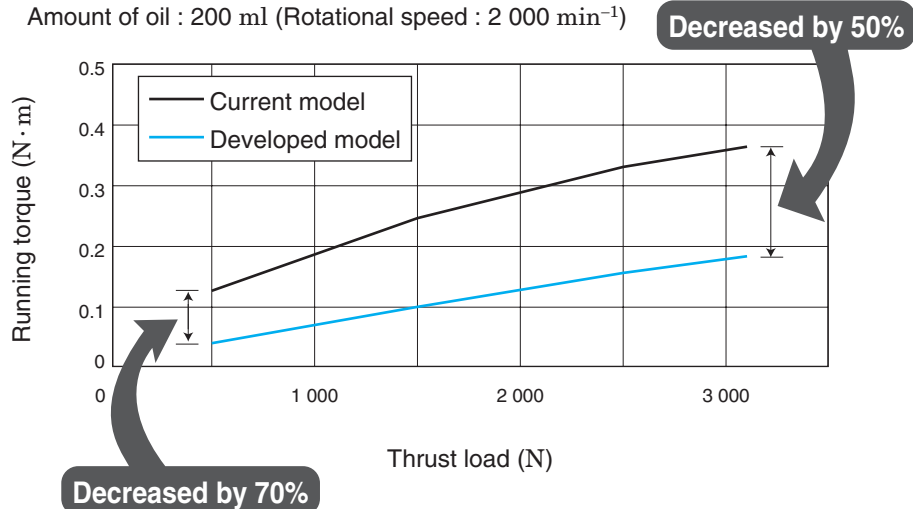

Rocker Roller (bearing for roller rocker arm)

Structure and characteristics

- Prevents wear and damage to cam (equivalent to conventional model for peeling resistance)
- Low cost
- Low torque

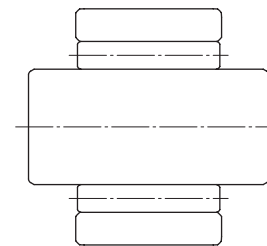
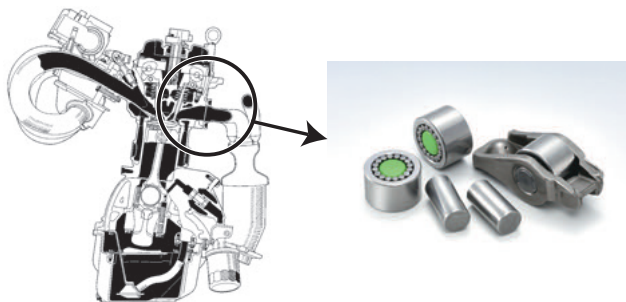

Cross section

Current model

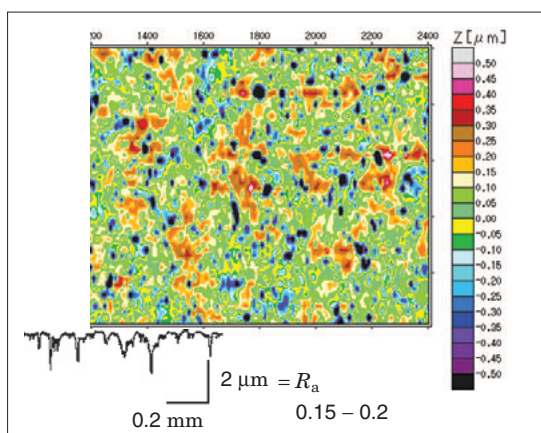

Shot blast and barrelling

Shot blast ⇒ Countermeasure against surface distress similar to the peeling made of micro-spalls : improved surface distress strength
 Barrelling ⇒ Improved surface roughness

Developed model

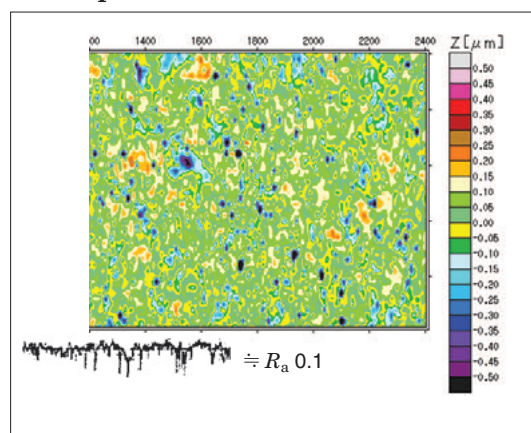

Tetratekt (special barrelling)

Optimization of barrelling conditions
 ⇒ Compatibility of omission of processes and improvement in surface layer fatigue strength and surface roughness

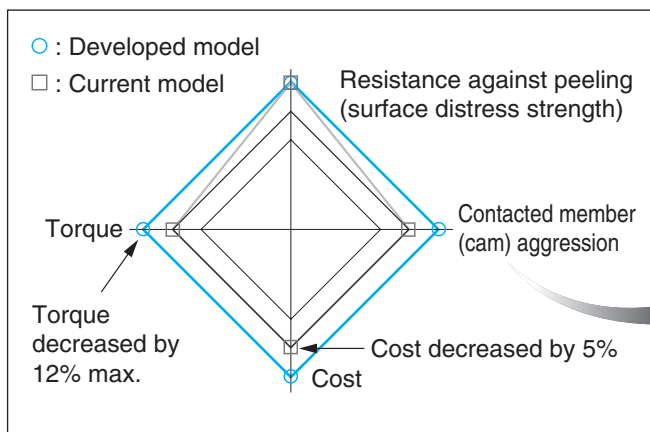

Evaluation of single low hardness cam (40 HRC)

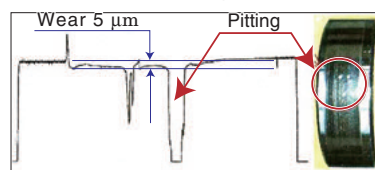

Current model

Contacted cam after test

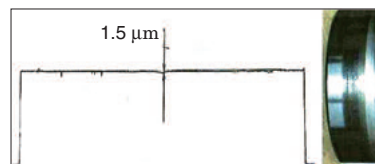

Developed model

Contacted cam after test

Developed model

- Wear of contacted cam is limited to half or less
- Pitting of contacted cam is prevented

Example of use

• Motorcycle, Engine

Special needle roller and cage assemblies are used for the large and small ends of connecting rods, and ordinary needle roller and cage assemblies are used for support of crankshafts. For support of shafts, machined ring needle roller bearings are used, and turning of the housings and outer rings are blocked by pins.

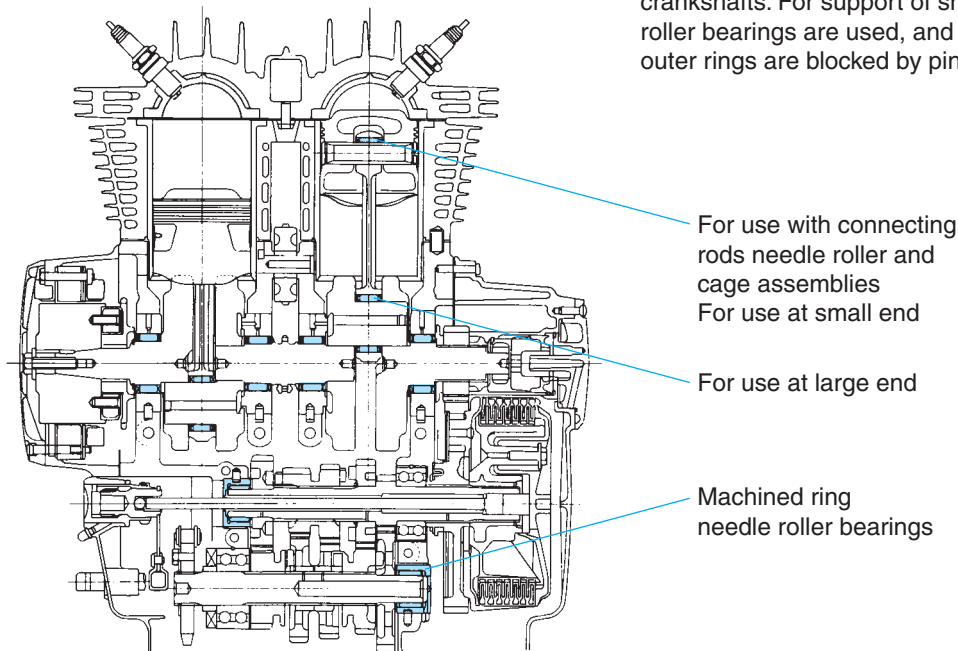

• Front Wheel Drive Mini-Vehicles, Transmission

Needle roller and cage assemblies are used for the main shafts and countershaft inner gears of transmissions.

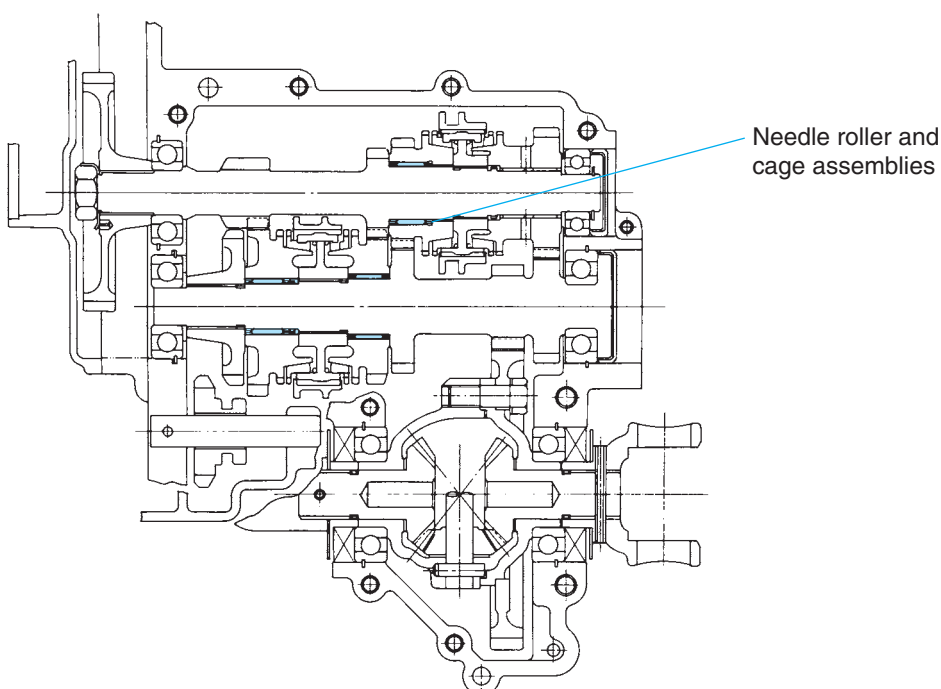

• **Front Wheel Drive Passenger Car, Transmission**

Needle roller and cage assemblies are used for the main shafts and countershaft inner gears of transmissions. For support of shafts, machined ring needle roller bearings are used.

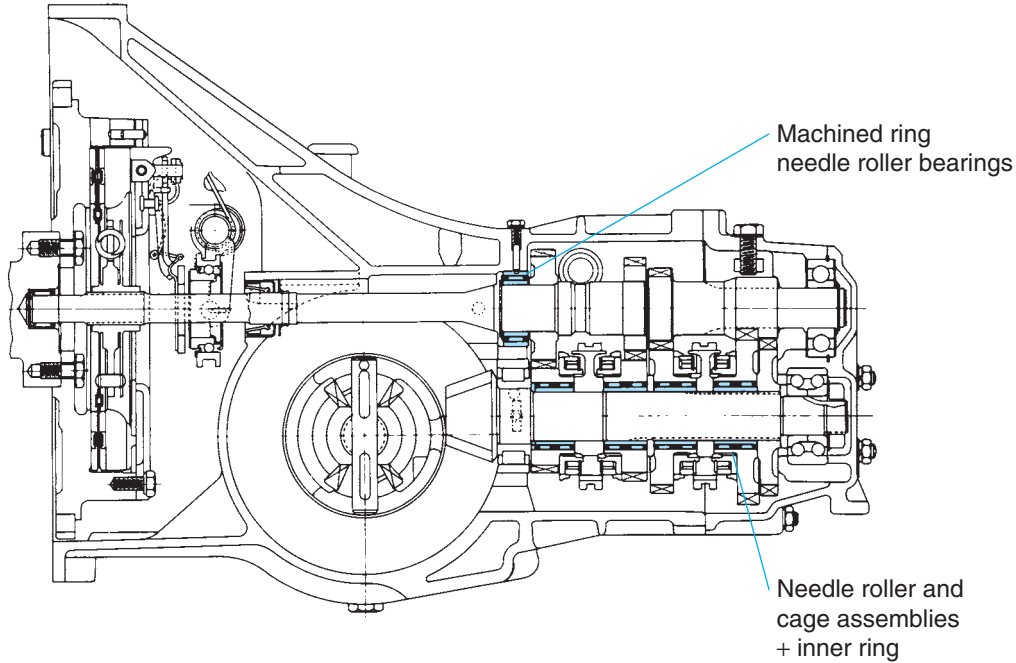

• **Rear Wheel Drive Passenger Car, Transmission**

Needle roller and cage assemblies are used for the inner gears of transmissions.

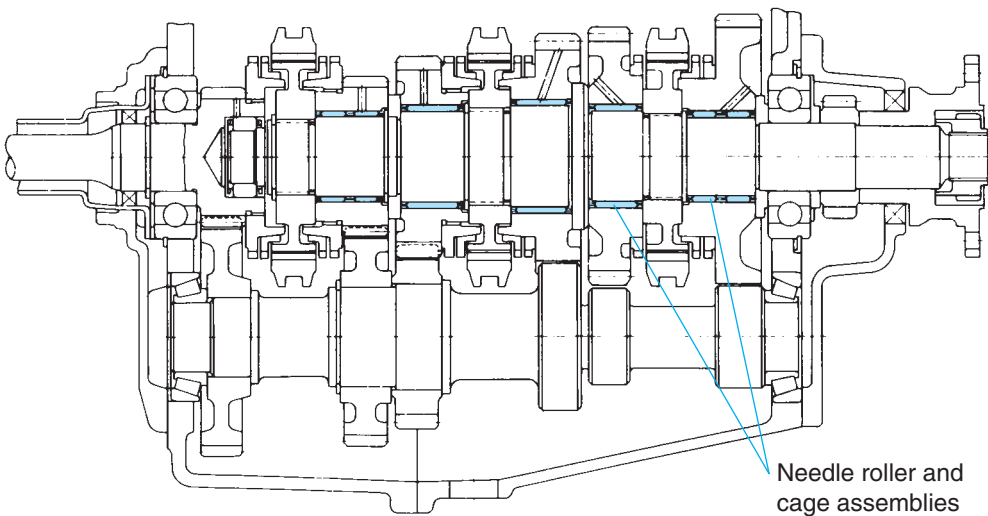

• Passenger Car, Steering Gear (Sector Shaft)

Although machined ring needle roller bearings have been used for support of sector shafts previously, use of drawn cup needle roller bearings has been recently spread for reduction of cost.

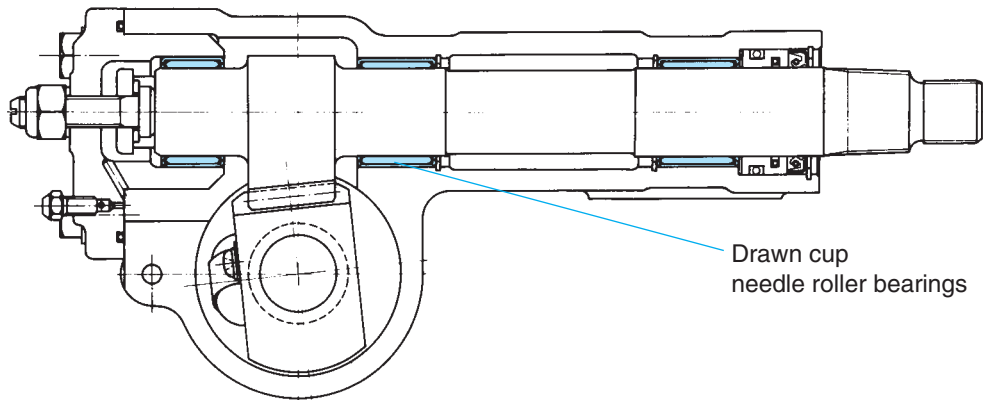

• Passenger Car, Front Suspension (Shock Absorber)

This is the example of a use of needle roller and cage thrust assemblies for a front suspension and shock absorber.

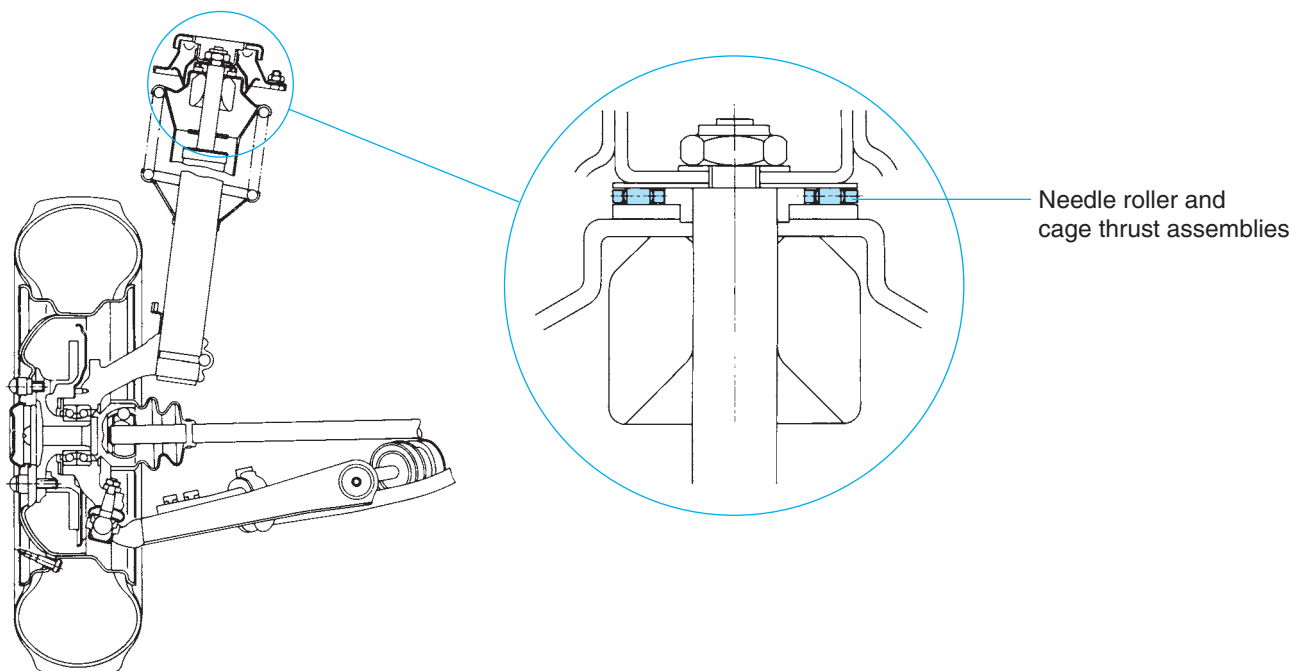

• **Passenger Car, Valve Lifter**

The roller followers, used for the valve lifters in the engines of automobiles, contribute to smooth rotation and reduction of running torque.

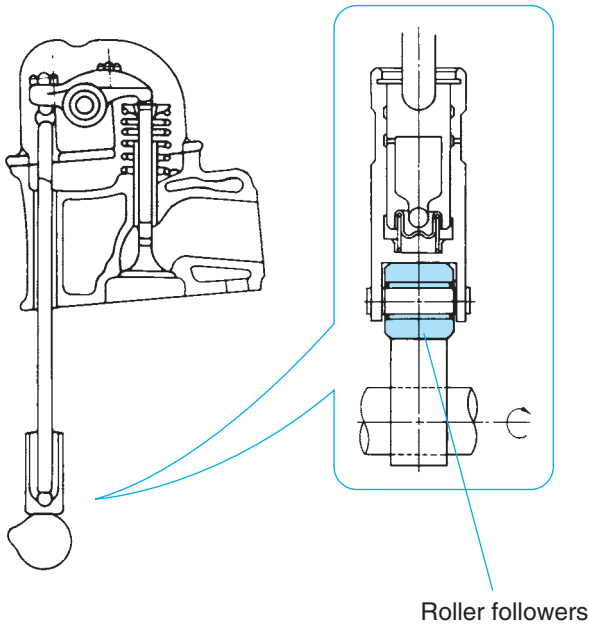

• **Alternator**

The closed end type drawn cup needle roller bearings are used for the other side of the pulleys in alternators.

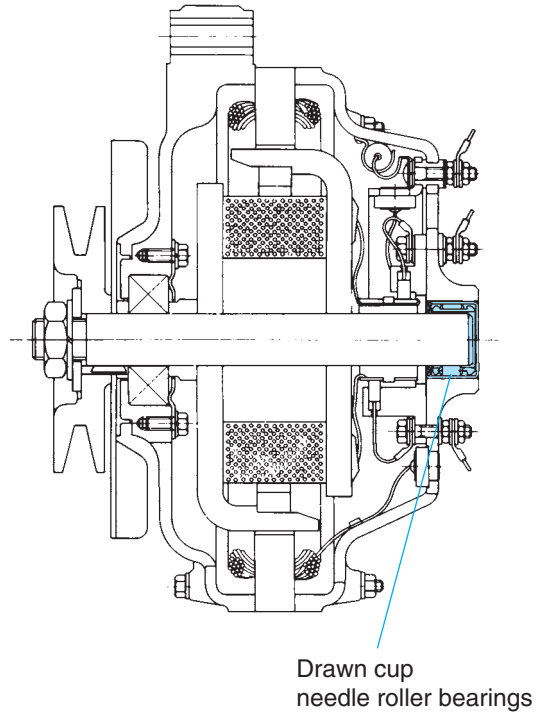

• **Cultivator, Transmisson**

This is the example of a use of drawn cup needle roller bearings in inner gears.

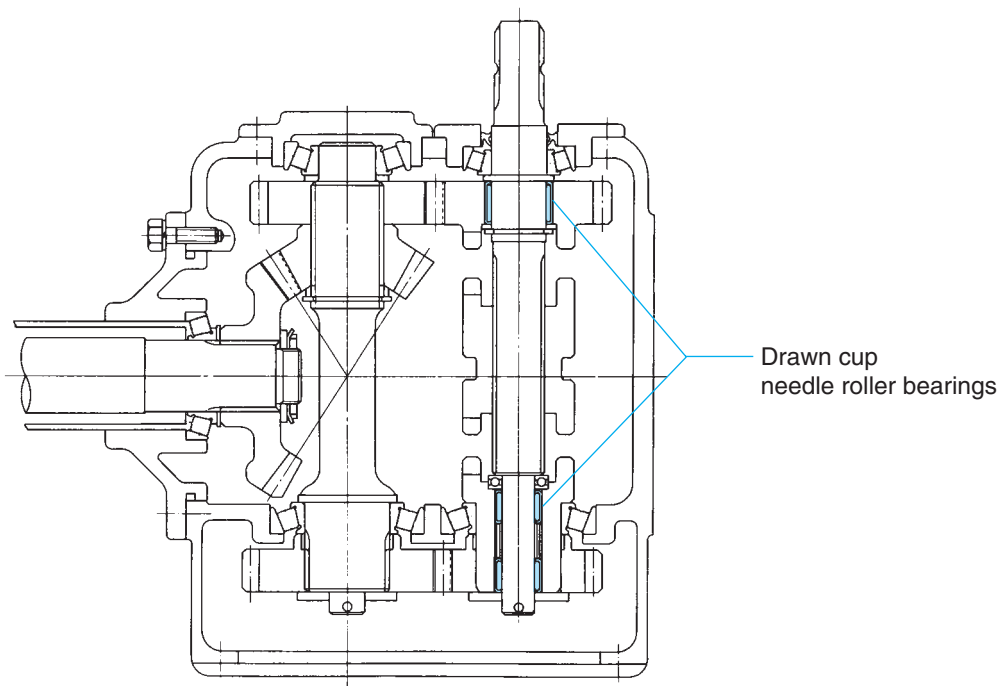

• Planetary Gear Reducer

In this example, machined ring needle roller bearings are used for support of the entire planetary gear unit, and needle roller and cage assemblies are used for the inner gears.

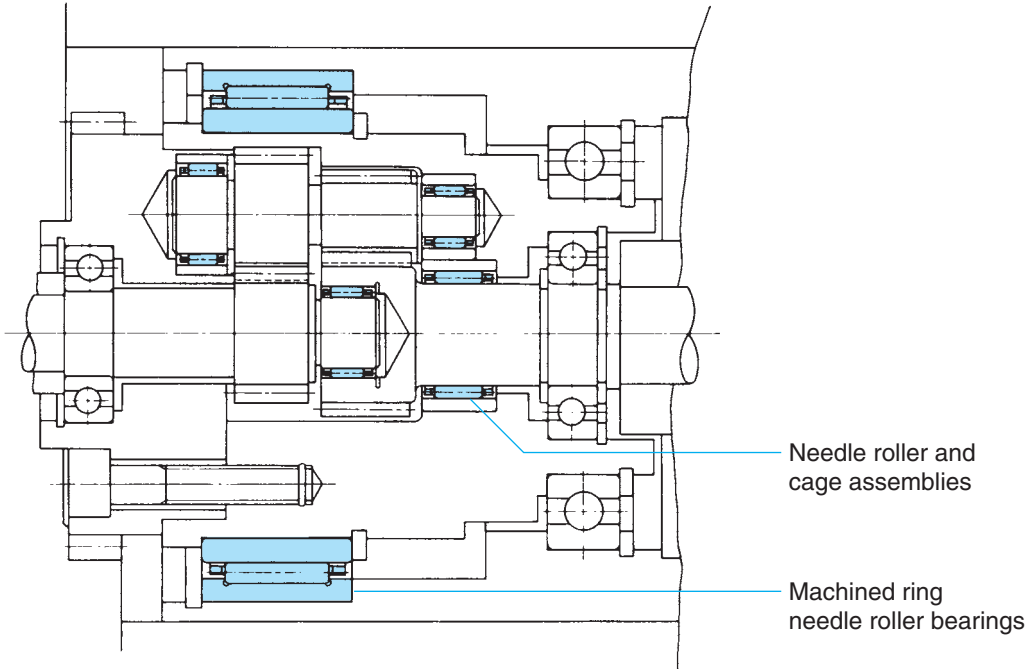

• Swash Plate Pump

In swash plate type pumps, machined ring needle roller bearings are used for support of main shafts, and needle roller thrust bearings are used for the swash plates.

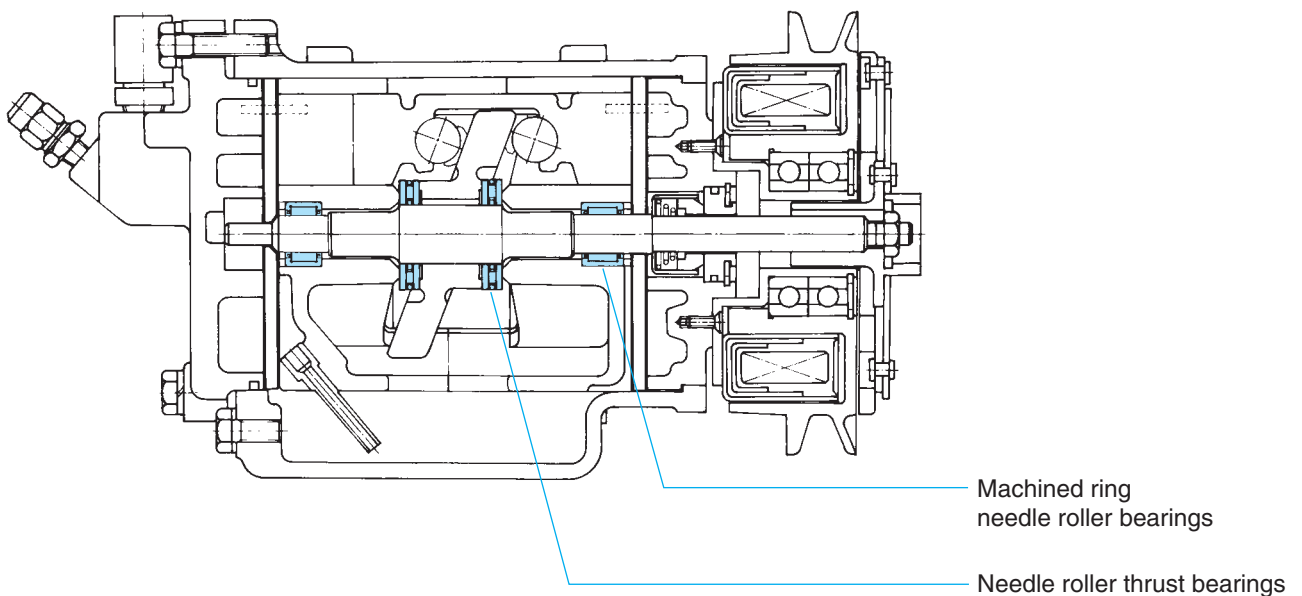

• Gear Pump

This is the example of a use of machined ring needle roller bearings in a gear pump.

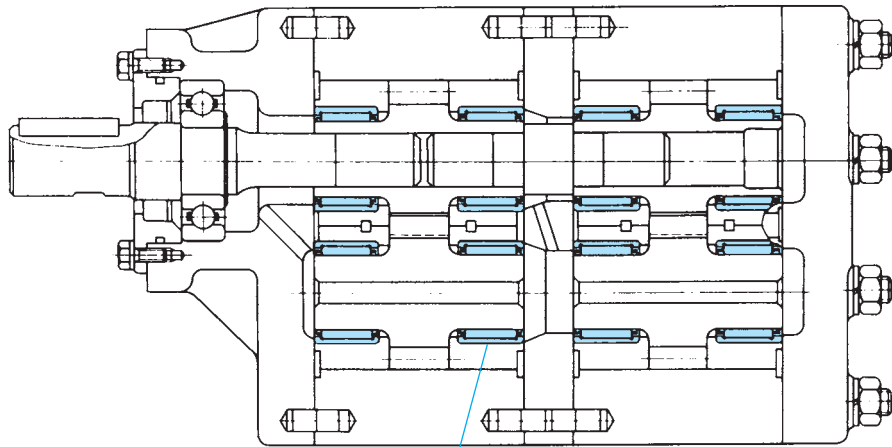

Machined ring
needle roller bearings

• Power Shovel, Wheel Drum

In this example, two machined ring needle roller bearings are used for support of a shaft.

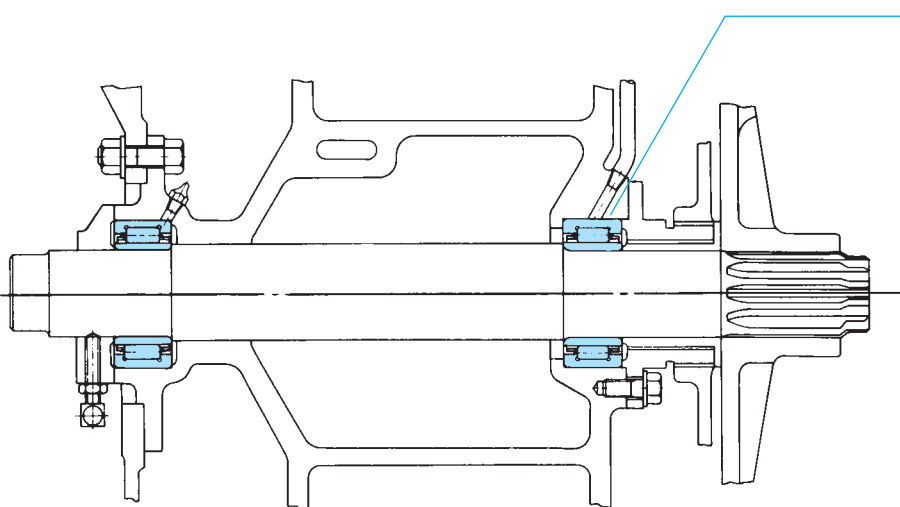

Machined ring
needle roller bearings

• Hoist

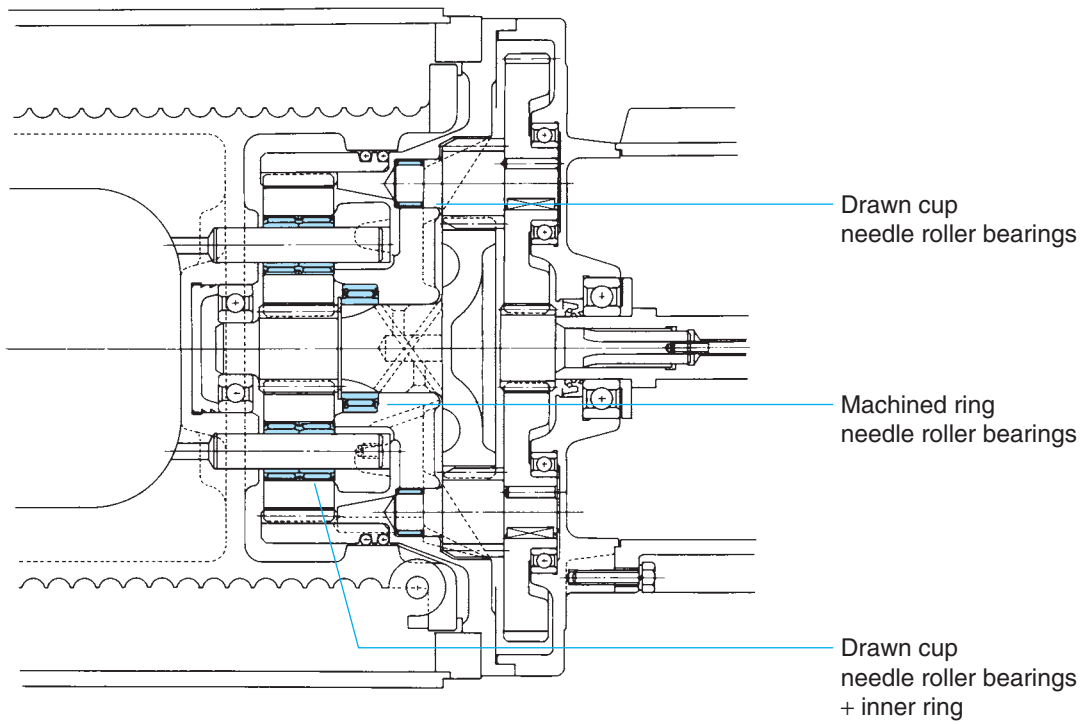

• Overhead Crane (1)

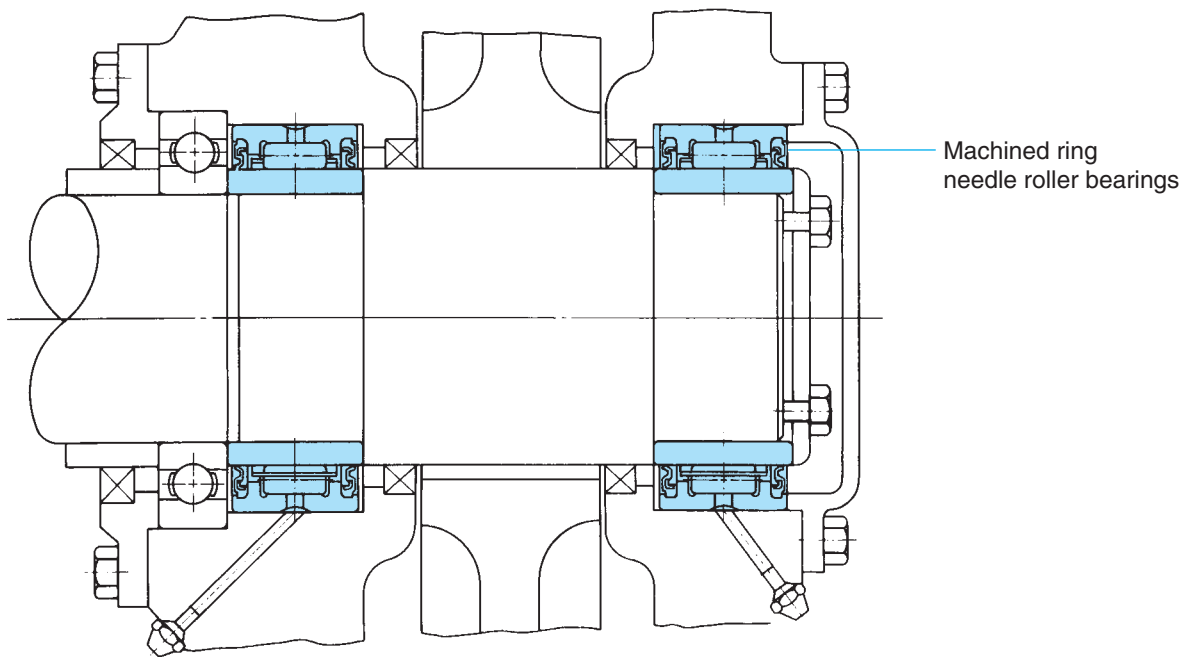

• Overhead Crane (2)

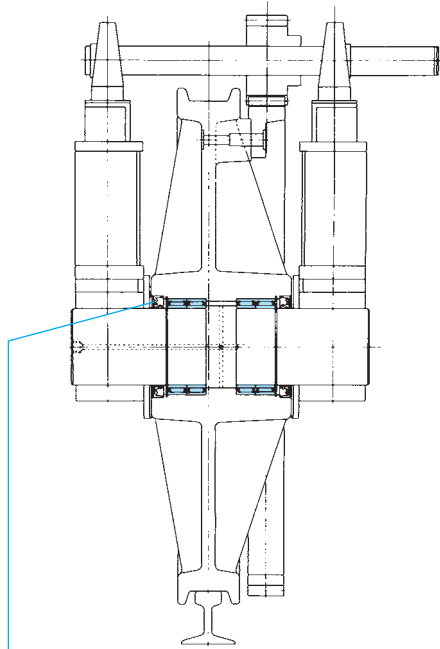

Machined ring
needle roller bearings

• Forklift Truck, King Pin

In this example, two drawn cup needle roller bearings are used for support of a king pin.

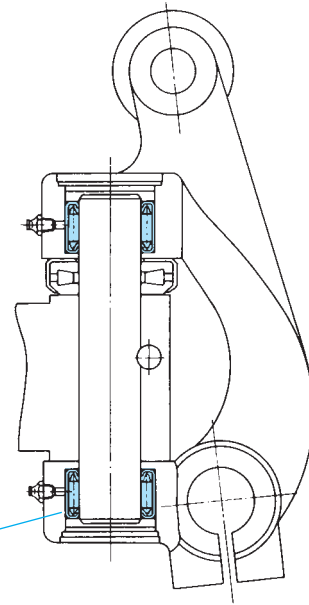

Drawn cup
needle roller bearings

• Multivane Rotary Compressor

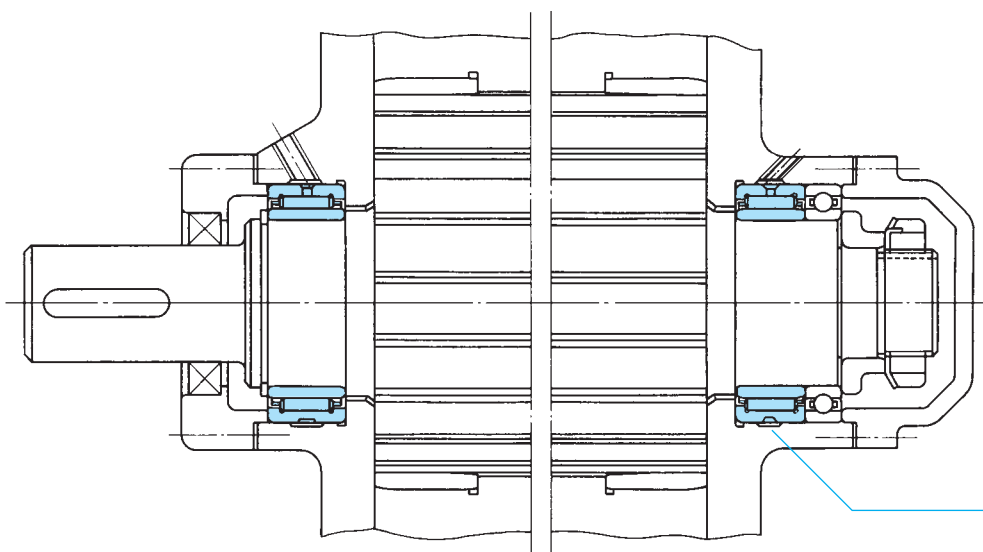

Machined ring
needle roller bearings

• Shutter Driving Gear

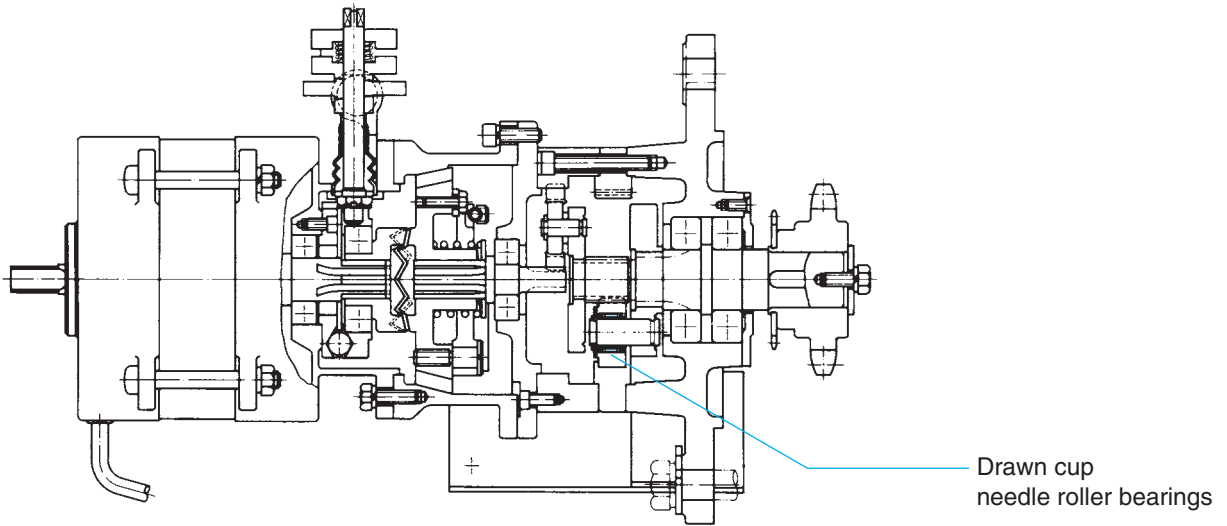

• Machine Tool, Bed

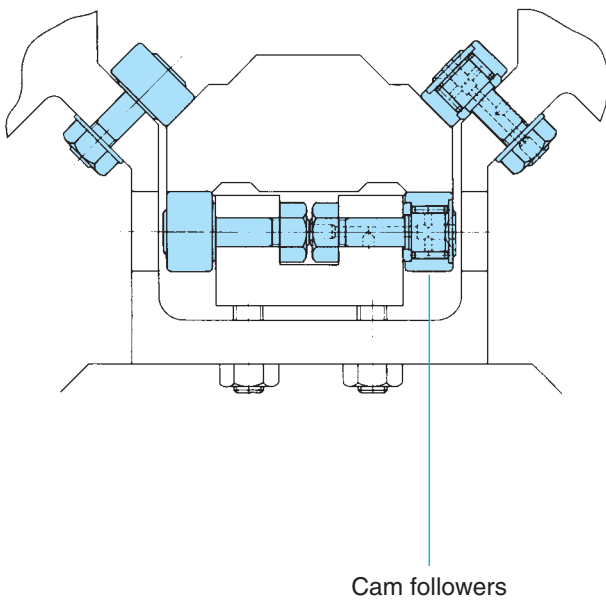

• Grinder Hoist

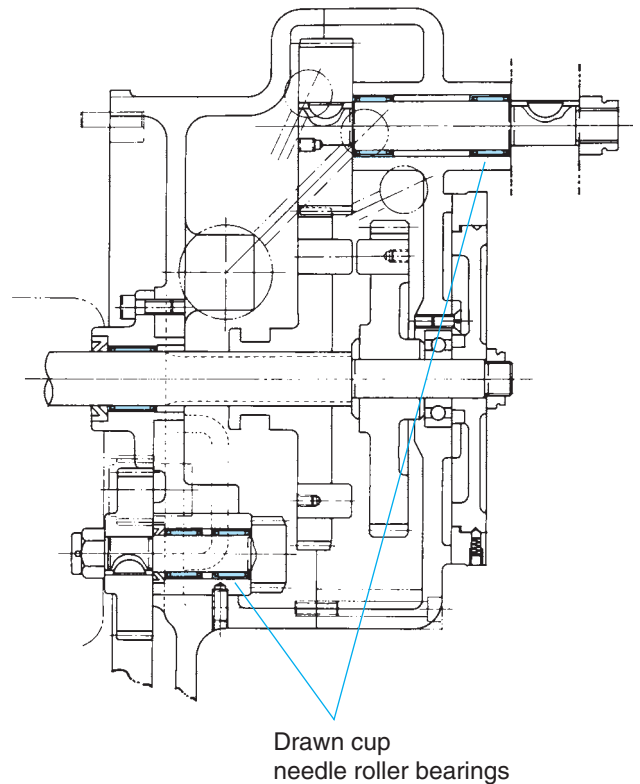

• Torque converter

In this example, needle roller thrust bearings are used in a torque converter.

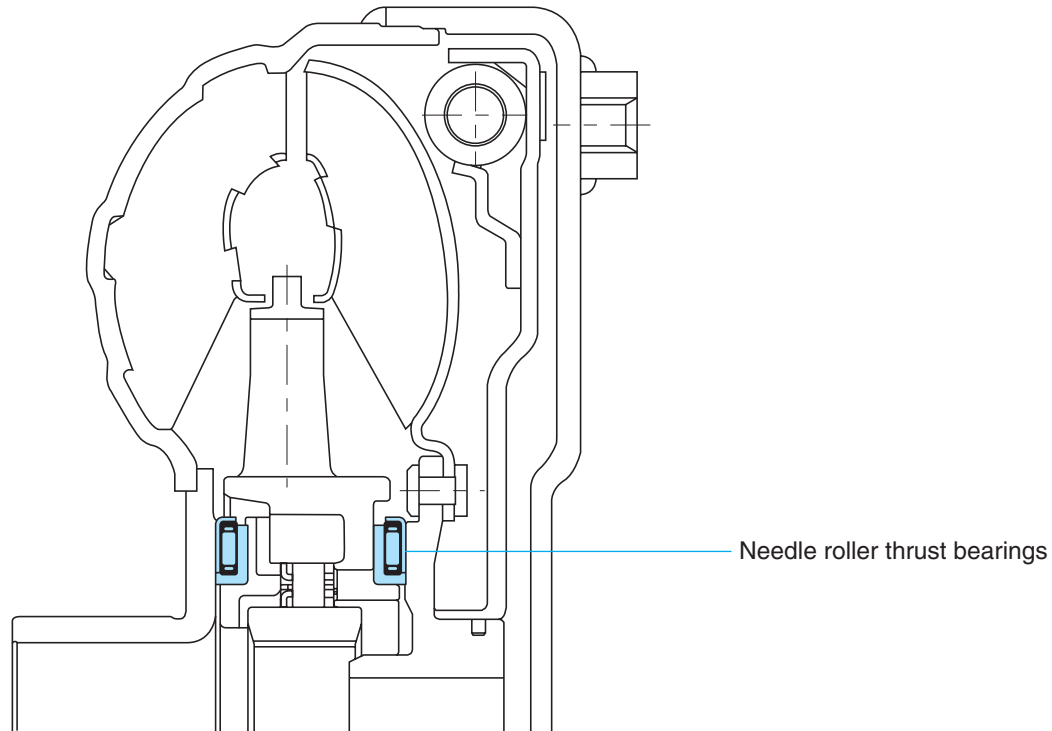

Supplementary tables

1	Shaft tolerances (deviation from nominal dimensions)	196
2	Housing bore tolerances (deviation from nominal dimensions)	198
3	SI units and conversion factors	200
4	Steel hardness conversion	204
5	Viscosity conversion	205
6	°C/°F conversion	206
7	Inch/millimeter conversion	207

Supplementary table 1 Shaft tolerances (deviation from nominal dimensions)

Nominal shaft dia. (mm)		Deviation classes of shaft dia.																
over	up to	c 12	d 6	e 6	e 7	e 12	f 5	f 6	g 5	g 6	h 5	h 6	h 7	h 8	h 9	h 10	h 11	h 12
3	6	-70 -190	-30 -38	-20 -28	-20 -32	-20 -140	-10 -15	-10 -18	-4 -9	-4 -12	0 -5	0 -8	0 -12	0 -18	0 -30	0 -48	0 -75	0 -120
6	10	-80 -230	-40 -49	-25 -34	-25 -40	-25 -175	-13 -19	-13 -22	-5 -11	-5 -14	0 -6	0 -9	0 -15	0 -22	0 -36	0 -58	0 -90	0 -150
10	18	-95 -275	-50 -61	-32 -43	-32 -50	-32 -212	-16 -24	-16 -27	-6 -14	-6 -17	0 -8	0 -11	0 -18	0 -27	0 -43	0 -70	0 -110	0 -180
18	30	-110 -320	-65 -78	-40 -53	-40 -61	-40 -250	-20 -29	-20 -33	-7 -16	-7 -20	0 -9	0 -13	0 -21	0 -33	0 -52	0 -84	0 -130	0 -210
30	40	-120 -370	-80 -96	-50 -66	-50 -75	-50 -300	-25 -36	-25 -41	-9 -20	-9 -25	0 -11	0 -16	0 -25	0 -39	0 -62	0 -100	0 -160	0 -250
40	50	-130 -380	-100 -119	-60 -79	-60 -90	-60 -360	-30 -43	-30 -49	-10 -23	-10 -29	0 -13	0 -19	0 -30	0 -46	0 -74	0 -120	0 -190	0 -300
50	65	-140 -440	-120 -142	-72 -94	-72 -107	-72 -422	-36 -51	-36 -58	-12 -27	-12 -34	0 -15	0 -22	0 -35	0 -54	0 -87	0 -140	0 -220	0 -350
65	80	-150 -450	-145 -170	-85 -110	-85 -125	-85 -485	-43 -61	-43 -68	-14 -32	-14 -39	0 -18	0 -25	0 -40	0 -63	0 -100	0 -160	0 -250	0 -400
80	100	-170 -520	-170 -199	-100 -129	-100 -146	-100 -560	-50 -70	-50 -79	-15 -35	-15 -44	0 -20	0 -29	0 -46	0 -72	0 -115	0 -185	0 -290	0 -460
100	120	-180 -530	-190 -222	-110 -142	-110 -162	-110 -630	-56 -79	-56 -88	-17 -40	-17 -49	0 -23	0 -32	0 -52	0 -81	0 -130	0 -210	0 -320	0 -520
120	140	-200 -600	-210 -610	-110 -142	-110 -162	-110 -630	-56 -79	-56 -88	-17 -40	-17 -49	0 -23	0 -32	0 -52	0 -81	0 -130	0 -210	0 -320	0 -520
140	160	-210 -610	-210 -246	-125 -161	-125 -182	-125 -695	-62 -87	-62 -98	-18 -43	-18 -54	0 -25	0 -36	0 -57	0 -89	0 -140	0 -230	0 -360	0 -570
160	180	-230 -630	-210 -246	-125 -161	-125 -182	-125 -695	-62 -87	-62 -98	-18 -43	-18 -54	0 -25	0 -36	0 -57	0 -89	0 -140	0 -230	0 -360	0 -570
180	200	-240 -700	-230 -270	-135 -175	-135 -198	-135 -765	-68 -95	-68 -108	-20 -47	-20 -60	0 -27	0 -40	0 -63	0 -97	0 -155	0 -250	0 -400	0 -630
200	225	-260 -720	-230 -270	-135 -175	-135 -198	-135 -765	-68 -95	-68 -108	-20 -47	-20 -60	0 -27	0 -40	0 -63	0 -97	0 -155	0 -250	0 -400	0 -630
225	250	-280 -740	-230 -270	-135 -175	-135 -198	-135 -765	-68 -95	-68 -108	-20 -47	-20 -60	0 -27	0 -40	0 -63	0 -97	0 -155	0 -250	0 -400	0 -630
250	280	-300 -820	-230 -270	-135 -175	-135 -198	-135 -765	-68 -95	-68 -108	-20 -47	-20 -60	0 -27	0 -40	0 -63	0 -97	0 -155	0 -250	0 -400	0 -630
280	315	-330 -850	-230 -270	-135 -175	-135 -198	-135 -765	-68 -95	-68 -108	-20 -47	-20 -60	0 -27	0 -40	0 -63	0 -97	0 -155	0 -250	0 -400	0 -630
315	355	-360 -930	-230 -270	-135 -175	-135 -198	-135 -765	-68 -95	-68 -108	-20 -47	-20 -60	0 -27	0 -40	0 -63	0 -97	0 -155	0 -250	0 -400	0 -630
355	400	-400 -970	-230 -270	-135 -175	-135 -198	-135 -765	-68 -95	-68 -108	-20 -47	-20 -60	0 -27	0 -40	0 -63	0 -97	0 -155	0 -250	0 -400	0 -630
400	450	-440 -1 070	-230 -270	-135 -175	-135 -198	-135 -765	-68 -95	-68 -108	-20 -47	-20 -60	0 -27	0 -40	0 -63	0 -97	0 -155	0 -250	0 -400	0 -630
450	500	-480 -1 110	-230 -270	-135 -175	-135 -198	-135 -765	-68 -95	-68 -108	-20 -47	-20 -60	0 -27	0 -40	0 -63	0 -97	0 -155	0 -250	0 -400	0 -630

[Note] 1) Δ_{dmp} : single plane mean bore diameter deviation

Unit : μm (Refer.)

															Nominal shaft dia. (mm)		$\Delta_{dmp}^{(1)}$ of bearing (class 0)
	js 5	js 6	j 5	j 6	k 5	k 6	m 5	m 6	n 5	n 6	p 5	p 6	r 6	r 7	over	up to	
± 2.5	± 4	+ 3 - 2	+ 6 - 2	+ 6 + 1	+ 9 + 1	+ 9 + 4	+12 + 4	+13 + 8	+16 + 8	+17 +12	+ 20 + 12	+ 23 + 15	+ 27 + 15	3	6	0 - 8	
± 3	± 4.5	+ 4 - 2	+ 7 - 2	+ 7 + 1	+10 + 1	+12 + 6	+15 + 6	+16 +10	+19 +10	+21 +15	+ 24 + 15	+ 28 + 19	+ 34 + 19	6	10	0 - 8	
± 4	± 5.5	+ 5 - 3	+ 8 - 3	+ 9 + 1	+12 + 1	+15 + 7	+18 + 7	+20 +12	+23 +12	+26 +18	+ 29 + 18	+ 34 + 23	+ 41 + 23	10	18	0 - 8	
± 4.5	± 6.5	+ 5 - 4	+ 9 - 4	+11 + 2	+15 + 2	+17 + 8	+21 + 8	+24 +15	+28 +15	+31 +22	+ 35 + 22	+ 41 + 28	+ 49 + 28	18	30	0 -10	
± 5.5	± 8	+ 6 - 5	+11 - 5	+13 + 2	+18 + 2	+20 + 9	+25 + 9	+28 +17	+33 +17	+37 +26	+ 42 + 26	+ 50 + 34	+ 59 + 34	30	50	0 -12	
± 6.5	± 9.5	+ 6 - 7	+12 - 7	+15 + 2	+21 + 2	+24 +11	+30 +11	+33 +20	+39 +20	+45 +32	+ 51 + 32	+ 60 + 41	+ 71 + 41	50	65	0 -15	
		+ 62 + 43	+ 73 + 43	65	80												
± 7.5	± 11	+ 6 - 9	+13 - 9	+18 + 3	+25 + 3	+28 +13	+35 +13	+38 +23	+45 +23	+52 +37	+ 59 + 37	+ 73 + 51	+ 86 + 51	80	100	0 -20	
		+ 76 + 54	+ 89 + 54	100	120												
± 9	± 12.5	+ 7 -11	+14 -11	+21 + 3	+28 + 3	+33 +15	+40 +15	+45 +27	+52 +27	+61 +43	+ 68 + 43	+ 88 + 63	+103 + 63	120	140	0 -25	
		+ 90 + 65	+105 + 65	140	160												
		+ 93 + 68	+108 + 68	160	180												
± 10	± 14.5	+ 7 -13	+16 -13	+24 + 4	+33 + 4	+37 +17	+46 +17	+51 +31	+60 +31	+70 +50	+ 79 + 50	+106 + 77	+123 + 77	180	200	0 -30	
		+109 + 80	+126 + 80	200	225												
		+113 + 84	+130 + 84	225	250												
± 11.5	± 16	+ 7 -16	± 16	+27 + 4	+36 + 4	+43 +20	+52 +20	+57 +34	+66 +34	+79 +56	+ 88 + 56	+126 + 94	+146 + 94	250	280	0 -35	
		+130 + 98	+150 + 98	280	315												
± 12.5	± 18	+ 7 -18	± 18	+29 + 4	+40 + 4	+46 +21	+57 +21	+62 +37	+73 +37	+87 +62	+ 98 + 62	+144 +108	+165 +108	315	355	0 -40	
		+150 +114	+171 +114	355	400												
± 13.5	± 20	+ 7 -20	± 20	+32 + 5	+45 + 5	+50 +23	+63 +23	+67 +40	+80 +40	+95 +68	+108 + 68	+166 +126	+189 +126	400	450	0 -45	
		+172 +132	+195 +132	450	500												

Supplementary table 2 Housing bore tolerances (deviation from nominal dimensions)

Nominal Bore dia. (mm)		Deviation classes of housing bore																
over	up to	E 7	E 10	E 11	E 12	F 6	F 7	F 8	G 6	G 7	H 5	H 6	H 7	H 8	H 9	H 10	JS 6	JS 7
3	6	+ 32 + 20	+ 68 + 20	+ 95 + 20	+140 + 20	+ 18 + 10	+ 22 + 10	+ 28 + 10	+12 + 4	+16 + 4	+ 5 0	+ 8 0	+12 0	+18 0	+ 30 0	+ 48 0	± 4	± 6
6	10	+ 40 + 25	+ 83 + 25	+115 + 25	+175 + 25	+ 22 + 13	+ 28 + 13	+ 35 + 13	+14 + 5	+20 + 5	+ 6 0	+ 9 0	+15 0	+22 0	+ 36 0	+ 58 0	± 4.5	± 7.5
10	18	+ 50 + 32	+102 + 32	+142 + 32	+212 + 32	+ 27 + 16	+ 34 + 16	+ 43 + 16	+17 + 6	+24 + 6	+ 8 0	+11 0	+18 0	+27 0	+ 43 0	+ 70 0	± 5.5	± 9
18	30	+ 61 + 40	+124 + 40	+170 + 40	+250 + 40	+ 33 + 20	+ 41 + 20	+ 53 + 20	+20 + 7	+28 + 7	+ 9 0	+13 0	+21 0	+33 0	+ 52 0	+ 84 0	± 6.5	±10.5
30	50	+ 75 + 50	+150 + 50	+210 + 50	+300 + 50	+ 41 + 25	+ 50 + 25	+ 64 + 25	+25 + 9	+34 + 9	+11 0	+16 0	+25 0	+39 0	+ 62 0	+100 0	± 8	±12.5
50	80	+ 90 + 60	+180 + 60	+250 + 60	+360 + 60	+ 49 + 30	+ 60 + 30	+ 76 + 30	+29 +10	+40 +10	+13 0	+19 0	+30 0	+46 0	+ 74 0	+120 0	± 9.5	±15
80	120	+107 + 72	+212 + 72	+292 + 72	+422 + 72	+ 58 + 36	+ 71 + 36	+ 90 + 36	+34 +12	+47 +12	+15 0	+22 0	+35 0	+54 0	+ 87 0	+140 0	±11	±17.5
120	180	+125 + 85	+245 + 85	+335 + 85	+485 + 85	+ 68 + 43	+ 83 + 43	+106 + 43	+39 +14	+54 +14	+18 0	+25 0	+40 0	+63 0	+100 0	+160 0	±12.5	±20
180	250	+146 +100	+285 +100	+390 +100	+560 +100	+ 79 + 50	+ 96 + 50	+122 + 50	+44 +15	+61 +15	+20 0	+29 0	+46 0	+72 0	+115 0	+185 0	±14.5	±23
250	315	+162 +110	+320 +110	+430 +110	+630 +110	+ 88 + 56	+108 + 56	+137 + 56	+49 +17	+69 +17	+23 0	+32 0	+52 0	+81 0	+130 0	+210 0	±16	±26
315	400	+182 +125	+355 +125	+485 +125	+695 +125	+ 98 + 62	+119 + 62	+151 + 62	+54 +18	+75 +18	+25 0	+36 0	+57 0	+89 0	+140 0	+230 0	±18	±28.5
400	500	+198 +135	+385 +135	+535 +135	+765 +135	+108 + 68	+131 + 68	+165 + 68	+60 +20	+83 +20	+27 0	+40 0	+63 0	+97 0	+155 0	+250 0	±20	±31.5

[Note] 1) Δ_{Dmp} : single plane mean outside diameter deviation

Unit : μm (Refer.)

													Nominal Bore dia. (mm)		$\Delta D_{\text{mp}}^{(1)}$ of bearing (class 0)
J6	J7	K6	K7	M6	M7	N6	N7	P6	P7	R6	R7	S7	over	up to	
+5	+6	+2	+3	-1	0	-5	-4	-9	-8	-12	-11	-15	3	6	0
-3	-6	-6	-9	-9	-12	-13	-16	-17	-20	-20	-23	-27			-8
+5	+8	+2	+5	-3	0	-7	-4	-12	-9	-16	-13	-17	6	10	0
-4	-7	-7	-10	-12	-15	-16	-19	-21	-24	-25	-28	-32			-8
+6	+10	+2	+6	-4	0	-9	-5	-15	-11	-20	-16	-21	10	18	0
-5	-8	-9	-12	-15	-18	-20	-23	-26	-29	-31	-34	-39			-8
+8	+12	+2	+6	-4	0	-11	-7	-18	-14	-24	-20	-27	18	30	0
-5	-9	-11	-15	-17	-21	-24	-28	-31	-35	-37	-41	-48			-9
+10	+14	+3	+7	-4	0	-12	-8	-21	-17	-29	-25	-34	30	50	0
-6	-11	-13	-18	-20	-25	-28	-33	-37	-42	-45	-50	-59			-11
+13	+18	+4	+9	-5	0	-14	-9	-26	-21	-35	-30	-42	50	65	0
-6	-12	-15	-21	-24	-30	-33	-39	-45	-51	-54	-60	-72			-13
										-37	-32	-48	65	80	
										-56	-62	-78			
+16	+22	+4	+10	-6	0	-16	-10	-30	-24	-44	-38	-58	80	100	0
-6	-13	-18	-25	-28	-35	-38	-45	-52	-59	-66	-73	-93			-15
										-47	-41	-66	100	120	
										-69	-76	-101			
+18	+26	+4	+12	-8	0	-20	-12	-36	-28	-56	-48	-77	120	140	(up to 150)
-7	-14	-21	-28	-33	-40	-45	-52	-61	-68	-81	-88	-117			0
										-58	-50	-85	140	160	-18
										-83	-90	-125			(over to 150)
										-61	-53	-93	160	180	0
										-86	-93	-133			-25
+22	+30	+5	+13	-8	0	-22	-14	-41	-33	-68	-60	-105	180	200	
-7	-16	-24	-33	-37	-46	-51	-60	-70	-79	-97	-106	-151			
										-71	-63	-113	200	225	0
										-100	-109	-159			-30
										-75	-67	-123	225	250	
										-104	-113	-169			
+25	+36	+5	+16	-9	0	-25	-14	-47	-36	-85	-74	-138	250	280	0
-7	-16	-27	-36	-41	-52	-57	-66	-79	-88	-117	-126	-190			-35
										-89	-78	-150	280	315	
										-121	-130	-202			
+29	+39	+7	+17	-10	0	-26	-16	-51	-41	-97	-87	-169	315	355	0
-7	-18	-29	-40	-46	-57	-62	-73	-87	-98	-133	-144	-226			-40
										-103	-93	-187	355	400	
										-139	-150	-244			
+33	+43	+8	+18	-10	0	-27	-17	-55	-45	-113	-103	-209	400	450	0
-7	-20	-32	-45	-50	-63	-67	-80	-95	-108	-153	-166	-272			-45
										-119	-109	-229	450	500	
										-159	-172	-292			

Supplementary table 3 (1) SI units and conversion factors

Mass	SI units	Other Units ¹⁾	Conversion into SI units	Conversion from SI units
Angle	rad [radian(s)]	° [degree(s)] * ' [minute(s)] * " [second(s)] *	1° = $\pi / 180$ rad 1' = $\pi / 10\,800$ rad 1" = $\pi / 648\,000$ rad	1 rad = 57.295 78°
Length	m [meter(s)]	Å [Angstrom unit] μ [micron(s)] in [inch(es)] ft [foot (feet)] yd [yard(s)] mile [mile(s)]	1 Å = 10^{-10} m = 0.1 nm = 100 pm 1 μ = 1 μm 1 in = 25.4 mm 1 ft = 12 in = 0.304 8 m 1 yd = 3 ft = 0.914 4 m 1 mile = 5 280 ft = 1 609.344 m	1 m = 10^{10} Å 1 m = 39.37 in 1 m = 3.280 8 ft 1 m = 1.093 6 yd 1 km = 0.621 4 mile
Area	m ²	a [are(s)] ha [hectare(s)] acre [acre(s)]	1 a = 100 m ² 1 ha = 10 ⁴ m ² 1 acre = 4 840 yd ² = 4 046.86 m ²	1 km ² = 247.1 acre
Volume	m ³	ℓ, L [liter(s)] * cc [cubic centimeters] gal (US) [gallon(s)] floz (US) [fluid ounce(s)] barrel (US) [barrels (US)]	1 ℓ = 1 dm ³ = 10 ⁻³ m ³ 1 cc = 1 cm ³ = 10 ⁻⁶ m ³ 1 gal (US) = 231 in ³ = 3.785 41 dm ³ 1 floz (US) = 29.573 5 cm ³ 1 barrel (US) = 158.987 dm ³	1 m ³ = 10 ³ ℓ 1 m ³ = 10 ⁶ cc 1 m ³ = 264.17 gal 1 m ³ = 33 814 floz 1 m ³ = 6.289 8 barrel
Time	s [second(s)]	min [minute(s)] * h [hour(s)] * d [day(s)] *		
Angular velocity	rad/s			
Velocity	m/s	kn [knot(s)] m/h *	1 kn = 1 852 m/h	1 km/h = 0.539 96 kn
Acceleration	m/s ²	G	1 G = 9.806 65 m/s ²	1 m/s ² = 0.101 97 G
Frequency	Hz [hertz]	c/s [cycle(s)/second]	1 c/s = 1 s ⁻¹ = 1 Hz	
Rotational frequency	s ⁻¹	rpm [revolutions per minute] min ⁻¹ * r/min	1 rpm = 1 / 60 s ⁻¹	1 s ⁻¹ = 60 rpm
Mass	kg [kilogram(s)]	t [ton(s)] * lb [pound(s)] gr [grain(s)] oz [ounce(s)] ton (UK) [ton(s) (UK)] ton (US) [ton(s) (US)] car [carat(s)]	1 t = 10 ³ kg 1 lb = 0.453 592 37 kg 1 gr = 64.798 91 mg 1 oz = 1 / 16 lb = 28.349 5 g 1 ton (UK) = 1 016.05 kg 1 ton (US) = 907.185 kg 1 car = 200 mg	1 kg = 2.204 6 lb 1 g = 15.432 4 gr 1 kg = 35.274 0 oz 1 t = 0.984 2 ton (UK) 1 t = 1.102 3 ton (US) 1 g = 5 car

[Note] 1) * : Unit can be used as an SI unit.
No asterisk : Unit cannot be used.

Supplementary table 3 (2) SI units and conversion factors

Mass	SI units	Other Units ¹⁾	Conversion into SI units	Conversion from SI units
Density	kg/m ³			
Linear density	kg/m			
Momentum	kg·m/s			
Moment of momentum, Angular momentum	} kg·m ² /s			
Moment of inertia		kg·m ²		
Force	N [newton(s)]	dyn [dyne(s)] kgf [kilogram-force] gf [gram-force] tf [ton-force] lbf [pound-force]	1 dyn = 10 ⁻⁵ N 1 kgf = 9.806 65 N 1 gf = 9.806 65 × 10 ⁻³ N 1 tf = 9.806 65 × 10 ³ N 1 lbf = 4.448 22 N	1 N = 10 ⁵ dyn 1 N = 0.101 97 kgf 1 N = 0.224 809 lbf
Moment of force	N·m [newton meter(s)]	gf·cm kgf·cm kgf·m tf·m lbf·ft	1 gf·cm = 9.806 65 × 10 ⁻⁵ N·m 1 kgf·cm = 9.806 65 × 10 ⁻² N·m 1 kgf·m = 9.806 65 N·m 1 tf·m = 9.806 65 × 10 ³ N·m 1 lbf·ft = 1.355 82 N·m	1 N·m = 0.101 97 kgf·m 1 N·m = 0.737 56 lbf·ft
Pressure, Normal stress	Pa [pascal(s)] or N/m ² {1 Pa = 1 N/m ² }	gf/cm ² kgf/mm ² kgf/m ² lbf/in ² bar [bar(s)] at [engineering air pressure] mH ₂ O, mAq [meter water column] atm [atmosphere] mHg [meter mercury column] Torr [torr]	1 gf/cm ² = 9.806 65 × 10 Pa 1 kgf/mm ² = 9.806 65 × 10 ⁶ Pa 1 kgf/m ² = 9.806 65 Pa 1 lbf/in ² = 6 894.76 Pa 1 bar = 10 ⁵ Pa 1 at = 1 kgf/cm ² = 9.806 65 × 10 ⁴ Pa 1 mH ₂ O = 9.806 65 × 10 ³ Pa 1 atm = 101 325 Pa 1 mHg = $\frac{101\ 325}{0.76}$ Pa 1 Torr = 1 mmHg = 133.322 Pa	1 MPa = 0.101 97 kgf/mm ² 1 Pa = 0.101 97 kgf/m ² 1 Pa = 0.145 × 10 ⁻³ lbf/in ² 1 Pa = 10 ⁻² mbar 1 Pa = 7.500 6 × 10 ⁻³ Torr
Viscosity	Pa·s [pascal second]	P [poise] kgf·s/m ²	10 ⁻² P = 1 cP = 1 mPa·s 1 kgf·s/m ² = 9.806 65 Pa·s	1 Pa·s = 0.101 97 kgf·s/m ²
Kinematic viscosity	m ² /s	St [stokes]	10 ⁻² St = 1 cSt = 1 mm ² /s	
Surface tension	N/m			

Supplementary table 3 (3) SI units and conversion factors

Mass	SI units	Other Units ¹⁾	Conversion into SI units	Conversion from SI units
Work, energy	J [joule(s)] {1 J = 1 N·m}	eV [electron volt(s)] * erg [erg(s)] kgf·m lbf·ft	1 eV = (1.602 189 2 ± 0.000 004 6) × 10 ⁻¹⁹ J 1 erg = 10 ⁻⁷ J 1 kgf·m = 9.806 65 J 1 lbf·ft = 1.355 82 J	1 J = 10 ⁷ erg 1 J = 0.101 97 kgf·m 1 J = 0.737 56 lbf·ft
Power	W [watt(s)]	erg / s [ergs per second] kgf·m / s PS [French horse-power] HP [horse-power (British)] lbf·ft / s	1 erg / s = 10 ⁻⁷ W 1 kgf·m / s = 9.806 65 W 1 PS = 75 kgf·m / s = 735.5 W 1 HP = 550 lbf·ft / s = 745.7 W 1 lbf·ft / s = 1.355 82 W	1 W = 0.101 97 kgf·m / s 1 W = 0.001 36 PS 1 W = 0.001 34 HP
Thermo-dynamic temperature	K [kelvin(s)]			
Celsius temperature	°C [celsius(s)] {t °C = (t + 273.15) K}	°F [degree(s) Fahrenheit]	t °F = $\frac{5}{9} (t - 32) °C$	t °C = $(\frac{9}{5} t + 32) °F$
Linear expansion coefficient	K ⁻¹	°C ⁻¹ [per degree]		
Heat	J [joule(s)] {1 J = 1 N·m}	erg [erg(s)] kgf·m cal _{IT} [l. T. calories]	1 erg = 10 ⁻⁷ J 1 cal _{IT} = 4.186 8 J 1 Mcal _{IT} = 1.163 kW·h	1 J = 10 ⁷ erg 1 J = 0.238 85 cal _{IT} 1 kW·h = 0.86 × 10 ⁶ cal _{IT}
Thermal conductivity	W / (m·K)	W / (m·°C) cal / (s·m·°C)	1 W / (m·°C) = 1 W / (m·K) 1 cal / (s·m·°C) = 4.186 05 W / (m·K)	
Coefficient of heat transfer	W / (m ² ·K)	W / (m ² ·°C) cal / (s·m ² ·°C)	1 W / (m ² ·°C) = 1 W / (m ² ·K) 1 cal / (s·m ² ·°C) = 4.186 05 W / (m ² ·K)	
Heat capacity	J / K	J / °C	1 J / °C = 1 J / K	
Massic heat capacity	J / (kg·K)	J / (kg·°C)		

[Note] 1) * : Unit can be used as an SI unit.
No asterisk : Unit cannot be used.

Supplementary table 3 (4) SI units and conversion factors

Mass	SI units	Other Units ¹⁾	Conversion into SI units	Conversion from SI units
Electric current	A [ampere(s)]			
Electric charge, quantity of electricity	C [coulomb(s)] {1 C = 1 A·s}	A·h	* 1 A·h = 3.6 kC	
Tension, electric potential	V [volt(s)] {1 V = 1 W/A}			
Capacitance	F [farad(s)] {1 F = 1 C/V}			
Magnetic field strength	A/m	Oe [oersted(s)]	$1 \text{ Oe} = \frac{10^3}{4\pi} \text{ A/m}$	$1 \text{ A/m} = 4\pi \times 10^{-3} \text{ Oe}$
Magnetic flux density	T [tesla(s)] { $1 \text{ T} = 1 \text{ N}/(\text{A}\cdot\text{m})$ = 1 Wb/m ² = 1 V·s/m ² }	Gs [gauss(es)] γ [gamma(s)]	$1 \text{ Gs} = 10^{-4} \text{ T}$ $1 \gamma = 10^{-9} \text{ T}$	$1 \text{ T} = 10^4 \text{ Gs}$ $1 \text{ T} = 10^9 \gamma$
Magnetic flux	Wb [weber(s)] {1 Wb = 1 V·s}	Mx [maxwell(s)]	$1 \text{ Mx} = 10^{-8} \text{ Wb}$	$1 \text{ Wb} = 10^8 \text{ Mx}$
Self inductance	H [henry (-ries)] {1 H = 1 Wb/A}			
Resistance (to direct current)	Ω [ohm(s)] {1 Ω = 1 V/A}			
Conductance (to direct current)	S [siemens] {1 S = 1 A/V}			
Active power	W { $1 \text{ W} = 1 \text{ J/s}$ = 1 A·V}			

Supplementary table 4 Steel hardness conversion

Rockwell C-scale 1 471.0 N (150 kgf)	Vicker's	Brinell		Rockwell		Shore
		Standard ball	Tungsten carbide ball	A-scale 588.4 N (60 kgf)	B-scale 980.7 N (100 kgf)	
68	940			85.6		97
67	900			85.0		95
66	865			84.5		92
65	832		739	83.9		91
64	800		722	83.4		88
63	772		705	82.8		87
62	746		688	82.3		85
61	720		670	81.8		83
60	697		654	81.2		81
59	674		634	80.7		80
58	653		615	80.1		78
57	633		595	79.6		76
56	613		577	79.0		75
55	595	—	560	78.5		74
54	577	—	543	78.0		72
53	560	—	525	77.4		71
52	544	500	512	76.8		69
51	528	487	496	76.3		68
50	513	475	481	75.9		67
49	498	464	469	75.2		66
48	484	451	455	74.7		64
47	471	442	443	74.1		63
46	458	432	432	73.6		62
45	446		421	73.1		60
44	434		409	72.5		58
43	423		400	72.0		57
42	412		390	71.5		56
41	402		381	70.9		55
40	392		371	70.4	—	54
39	382		362	69.9	—	52
38	372		353	69.4	—	51
37	363		344	68.9	—	50
36	354		336	68.4	(109.0)	49
35	345		327	67.9	(108.5)	48
34	336		319	67.4	(108.0)	47
33	327		311	66.8	(107.5)	46
32	318		301	66.3	(107.0)	44
31	310		294	65.8	(106.0)	43
30	302		286	65.3	(105.5)	42
29	294		279	64.7	(104.5)	41
28	286		271	64.3	(104.0)	41
27	279		264	63.8	(103.0)	40
26	272		258	63.3	(102.5)	38
25	266		253	62.8	(101.5)	38
24	260		247	62.4	(101.0)	37
23	254		243	62.0	100.0	36
22	248		237	61.5	99.0	35
21	243		231	61.0	98.5	35
20	238		226	60.5	97.8	34
(18)	230		219	—	96.7	33
(16)	222		212	—	95.5	32
(14)	213		203	—	93.9	31
(12)	204		194	—	92.3	29
(10)	196		187		90.7	28
(8)	188		179		89.5	27
(6)	180		171		87.1	26
(4)	173		165		85.5	25
(2)	166		158		83.5	24
(0)	160		152		81.7	24

Supplementary table 5 Viscosity conversion

Kinematic viscosity mm ² /s	Saybolt SUS (second)		Redwood R (second)		Engler E (degree)
	100 °F	210 °F	50 °C	100 °C	
2	32.6	32.8	30.8	31.2	1.14
3	36.0	36.3	33.3	33.7	1.22
4	39.1	39.4	35.9	36.5	1.31
5	42.3	42.6	38.5	39.1	1.40
6	45.5	45.8	41.1	41.7	1.48
7	48.7	49.0	43.7	44.3	1.56
8	52.0	52.4	46.3	47.0	1.65
9	55.4	55.8	49.1	50.0	1.75
10	58.8	59.2	52.1	52.9	1.84
11	62.3	62.7	55.1	56.0	1.93
12	65.9	66.4	58.2	59.1	2.02
13	69.6	70.1	61.4	62.3	2.12
14	73.4	73.9	64.7	65.6	2.22
15	77.2	77.7	68.0	69.1	2.32
16	81.1	81.7	71.5	72.6	2.43
17	85.1	85.7	75.0	76.1	2.54
18	89.2	89.8	78.6	79.7	2.64
19	93.3	94.0	82.1	83.6	2.76
20	97.5	98.2	85.8	87.4	2.87
21	102	102	89.5	91.3	2.98
22	106	107	93.3	95.1	3.10
23	110	111	97.1	98.9	3.22
24	115	115	101	103	3.34
25	119	120	105	107	3.46
26	123	124	109	111	3.58
27	128	129	112	115	3.70
28	132	133	116	119	3.82
29	137	138	120	123	3.95
30	141	142	124	127	4.07
31	145	146	128	131	4.20
32	150	150	132	135	4.32
33	154	155	136	139	4.45
34	159	160	140	143	4.57

Kinematic viscosity mm ² /s	Saybolt SUS (second)		Redwood R (second)		Engler E (degree)
	100 °F	210 °F	50 °C	100 °C	
35	163	164	144	147	4.70
36	168	170	148	151	4.83
37	172	173	153	155	4.96
38	177	178	156	159	5.08
39	181	183	160	164	5.21
40	186	187	164	168	5.34
41	190	192	168	172	5.47
42	195	196	172	176	5.59
43	199	201	176	180	5.72
44	204	205	180	185	5.85
45	208	210	184	189	5.98
46	213	215	188	193	6.11
47	218	219	193	197	6.24
48	222	224	197	202	6.37
49	227	228	201	206	6.50
50	231	233	205	210	6.63
55	254	256	225	231	7.24
60	277	279	245	252	7.90
65	300	302	266	273	8.55
70	323	326	286	294	9.21
75	346	349	306	315	9.89
80	371	373	326	336	10.5
85	394	397	347	357	11.2
90	417	420	367	378	11.8
95	440	443	387	399	12.5
100	464	467	408	420	13.2
120	556	560	490	504	15.8
140	649	653	571	588	18.4
160	742	747	653	672	21.1
180	834	840	734	757	23.7
200	927	933	816	841	26.3
250	1 159	1 167	1 020	1 051	32.9
300	1 391	1 400	1 224	1 241	39.5

[Remark] 1 mm²/s = 1 cSt (centi stokes)

Supplementary table 6 °C/°F conversion

°C		°F	°C		°F	°C		°F	°C		°F
-73	-100	-148	- 1.6	29	84.2	17.7	64	147.2	37.1	99	210.2
-62	- 80	-112	- 1.1	30	86.0	18.2	65	149.0	37.7	100	212
-51	- 60	- 76	- 0.6	31	87.8	18.8	66	150.8	40.6	105	221
-40	- 40	- 40	0	32	89.6	19.3	67	152.6	43	110	230
-29	- 20	- 4	0.5	33	91.4	19.9	68	154.4	49	120	248
-23.3	- 10	14	1.1	34	93.2	20.4	69	156.2	54	130	266
-17.7	0	32	1.6	35	95.0	21.0	70	158.0	60	140	284
-17.2	1	33.8	2.2	36	96.8	21.5	71	159.8	65	150	302
-16.6	2	35.6	2.7	37	98.6	22.2	72	161.6	71	160	320
-16.1	3	37.4	3.3	38	100.4	22.7	73	163.4	76	170	338
-15.5	4	39.2	3.8	39	102.2	23.3	74	165.2	83	180	356
-15.0	5	41.0	4.4	40	104.0	23.8	75	167.0	88	190	374
-14.4	6	42.8	4.9	41	105.8	24.4	76	168.8	93	200	392
-13.9	7	44.6	5.4	42	107.6	25.0	77	170.6	121	250	482
-13.3	8	46.4	6.0	43	109.4	25.5	78	172.4	149	300	572
-12.7	9	48.2	6.6	44	111.2	26.2	79	174.2	177	350	662
-12.2	10	50.0	7.1	45	113.0	26.8	80	176.0	204	400	752
-11.6	11	51.8	7.7	46	114.8	27.3	81	177.8	232	450	842
-11.1	12	53.6	8.2	47	116.6	27.7	82	179.6	260	500	932
-10.5	13	55.4	8.8	48	118.4	28.2	83	181.4	288	550	1 022
-10.0	14	57.2	9.3	49	120.2	28.8	84	183.2	315	600	1 112
- 9.4	15	59.0	9.9	50	122.0	29.3	85	185.0	343	650	1 202
- 8.8	16	61.8	10.4	51	123.8	29.9	86	186.8	371	700	1 292
- 8.3	17	63.6	11.1	52	125.6	30.4	87	188.6	399	750	1 382
- 7.7	18	65.4	11.5	53	127.4	31.0	88	190.4	426	800	1 472
- 7.2	19	67.2	12.1	54	129.2	31.5	89	192.2	454	850	1 562
- 6.6	20	68.0	12.6	55	131.0	32.1	90	194.0	482	900	1 652
- 6.1	21	69.8	13.2	56	132.8	32.6	91	195.8	510	950	1 742
- 5.5	22	71.6	13.7	57	134.6	33.3	92	197.6	538	1 000	1 832
- 5.0	23	73.4	14.3	58	136.4	33.8	93	199.4	593	1 100	2 012
- 4.4	24	75.2	14.8	59	138.2	34.4	94	201.2	648	1 200	2 192
- 3.9	25	77.0	15.6	60	140.0	34.9	95	203.0	704	1 300	2 372
- 3.3	26	78.8	16.1	61	141.8	35.5	96	204.8	760	1 400	2 552
- 2.8	27	80.6	16.6	62	143.6	36.1	97	206.6	815	1 500	2 732
- 2.2	28	82.4	17.1	63	145.4	36.6	98	208.4	871	1 600	2 937

[Example] The center columns of numbers is the temperature in either degrees Centigrade (°C) or Fahrenheit (°F) whichever is desired to convert into the other. If degrees Fahrenheit is given, read degrees Centigrade to the left. If degrees Centigrade is given, read degrees Fahrenheit to the right.

$$C = \frac{5}{9} (F - 32)$$

$$F = \frac{9}{5} (C + 32)$$

Supplementary table 7 Inch/millimeter conversion

Inch		Inches										
		0	1	2	3	4	5	6	7	8	9	10
		mm										
0	0	0	25.4000	50.8000	76.2000	101.6000	127.0000	152.4000	177.8000	203.2000	228.6000	254.0000
1/64	0.015625	0.3969	25.7969	51.1969	76.5969	101.9969	127.3969	152.7969	178.1969	203.5969	228.9969	254.3969
1/32	0.03125	0.7938	26.1938	51.5938	76.9938	102.3938	127.7938	153.1938	178.5938	203.9938	229.3938	254.7938
3/64	0.046875	1.1906	26.5906	51.9906	77.3906	102.7906	128.1906	153.5906	178.9906	204.3906	229.7906	255.1906
1/16	0.0625	1.5875	26.9875	52.3875	77.7875	103.1875	128.5875	153.9875	179.3875	204.7875	230.1875	255.5875
5/64	0.078125	1.9844	27.3844	52.7844	78.1844	103.5844	128.9844	154.3844	179.7844	205.1844	230.5844	255.9844
3/32	0.09375	2.3812	27.7812	53.1812	78.5812	103.9812	129.3812	154.7812	180.1812	205.5812	230.9812	256.3812
7/64	0.109375	2.7781	28.1781	53.5781	78.9781	104.3781	129.7781	155.1781	180.5781	205.9781	231.3781	256.7781
1/8	0.125	3.1750	28.5750	53.9750	79.3750	104.7750	130.1750	155.5750	180.9750	206.3750	231.7750	257.1750
9/64	0.140625	3.5719	28.9719	54.3719	79.7719	105.1719	130.5719	155.9719	181.3719	206.7719	232.1719	257.5719
5/32	0.15625	3.9688	29.3688	54.7688	80.1688	105.5688	130.9688	156.3688	181.7688	207.1688	232.5688	257.9688
11/64	0.171875	4.3656	29.7656	55.1656	80.5656	105.9656	131.3656	156.7656	182.1656	207.5656	232.9656	258.3656
3/16	0.1875	4.7625	30.1625	55.5625	80.9625	106.3625	131.7625	157.1625	182.5625	207.9625	233.3625	258.7625
13/64	0.203125	5.1594	30.5594	55.9594	81.3594	106.7594	132.1594	157.5594	182.9594	208.3594	233.7594	259.1594
7/32	0.21875	5.5562	30.9562	56.3562	81.7562	107.1562	132.5562	157.9562	183.3562	208.7562	234.1562	259.5562
15/64	0.234375	5.9531	31.3531	56.7531	82.1531	107.5531	132.9531	158.3531	183.7531	209.1531	234.5531	259.9531
1/4	0.25	6.3500	31.7500	57.1500	82.5500	107.9500	133.3500	158.7500	184.1500	209.5500	234.9500	260.3500
17/64	0.265625	6.7469	32.1469	57.5469	82.9469	108.3469	133.7469	159.1469	184.5469	209.9469	235.3469	260.7469
9/32	0.28125	7.1438	32.5438	57.9438	83.3438	108.7438	134.1438	159.5438	184.9438	210.3438	235.7438	261.1438
19/64	0.296875	7.5406	32.9406	58.3406	83.7406	109.1406	134.5406	159.9406	185.3406	210.7406	236.1406	261.5406
5/16	0.3125	7.9375	33.3375	58.7375	84.1375	109.5375	134.9375	160.3375	185.7375	211.1375	236.5375	261.9375
21/64	0.328125	8.3344	33.7344	59.1344	84.5344	109.9344	135.3344	160.7344	186.1344	211.5344	236.9344	262.3344
11/32	0.34375	8.7312	34.1312	59.5312	84.9312	110.3312	135.7312	161.1312	186.5312	211.9312	237.3312	262.7312
23/64	0.359375	9.1281	34.5281	59.9281	85.3281	110.7281	136.1281	161.5281	186.9281	212.3281	237.7281	263.1281
3/8	0.375	9.5250	34.9250	60.3250	85.7250	111.1250	136.5250	161.9250	187.3250	212.7250	238.1250	263.5250
25/64	0.390625	9.9219	35.3219	60.7219	86.1219	111.5219	136.9219	162.3219	187.7219	213.1219	238.5219	263.9219
13/32	0.40625	10.3188	35.7188	61.1188	86.5188	111.9188	137.3188	162.7188	188.1188	213.5188	238.9188	264.3188
27/64	0.421875	10.7156	36.1156	61.5156	86.9156	112.3156	137.7156	163.1156	188.5156	213.9156	239.3156	264.7156
7/16	0.4375	11.1125	36.5125	61.9125	87.3125	112.7125	138.1125	163.5125	188.9125	214.3125	239.7125	265.1125
29/64	0.453125	11.5094	36.9094	62.3094	87.7094	113.1094	138.5094	163.9094	189.3094	214.7094	240.1094	265.5094
15/32	0.46875	11.9062	37.3062	62.7062	88.1062	113.5062	138.9062	164.3062	189.7062	215.1062	240.5062	265.9062
31/64	0.484375	12.3031	37.7031	63.1031	88.5031	113.9031	139.3031	164.7031	190.1031	215.5031	240.9031	266.3031
1/2	0.5	12.7000	38.1000	63.5000	88.9000	114.3000	139.7000	165.1000	190.5000	215.9000	241.3000	266.7000
33/64	0.515625	13.0969	38.4969	63.8969	89.2969	114.6969	140.0969	165.4969	190.8969	216.2969	241.6969	267.0969
17/32	0.53125	13.4938	38.8938	64.2938	89.6938	115.0938	140.4938	165.8938	191.2938	216.6938	242.0938	267.4938
35/64	0.546875	13.8906	39.2906	64.6906	90.0906	115.4906	140.8906	166.2906	191.6906	217.0906	242.4906	267.8906
9/16	0.5625	14.2875	39.6875	65.0875	90.4875	115.8875	141.2875	166.6875	192.0875	217.4875	242.8875	268.2875
37/64	0.578125	14.6844	40.0844	65.4844	90.8844	116.2844	141.6844	167.0844	192.4844	217.8844	243.2844	268.6844
19/32	0.59375	15.0812	40.4812	65.8812	91.2812	116.6812	142.0812	167.4812	192.8812	218.2812	243.6812	269.0812
39/64	0.609375	15.4781	40.8781	66.2781	91.6781	117.0781	142.4781	167.8781	193.2781	218.6781	244.0781	269.4781
5/8	0.625	15.8750	41.2750	66.6750	92.0750	117.4750	142.8750	168.2750	193.6750	219.0750	244.4750	269.8750
41/64	0.640625	16.2719	41.6719	67.0719	92.4719	117.8719	143.2719	168.6719	194.0719	219.4719	244.8719	270.2719
21/32	0.65625	16.6688	42.0688	67.4688	92.8688	118.2688	143.6688	169.0688	194.4688	219.8688	245.2688	270.6688
43/64	0.671875	17.0656	42.4656	67.8656	93.2656	118.6656	144.0656	169.4656	194.8656	220.2656	245.6656	271.0656
11/16	0.6875	17.4625	42.8625	68.2625	93.6625	119.0625	144.4625	169.8625	195.2625	220.6625	246.0625	271.4625
45/64	0.703125	17.8594	43.2594	68.6594	94.0594	119.4594	144.8594	170.2594	195.6594	221.0594	246.4594	271.8594
23/32	0.71875	18.2562	43.6562	69.0562	94.4562	119.8562	145.2562	170.6562	196.0562	221.4562	246.8562	272.2562
47/64	0.734375	18.6531	44.0531	69.4531	94.8531	120.2531	145.6531	171.0531	196.4531	221.8531	247.2531	272.6531
3/4	0.75	19.0500	44.4500	69.8500	95.2500	120.6500	146.0500	171.4500	196.8500	222.2500	247.6500	273.0500
49/64	0.765625	19.4469	44.8469	70.2469	95.6469	121.0469	146.4469	171.8469	197.2469	222.6469	248.0469	273.4469
25/32	0.78125	19.8438	45.2438	70.6438	96.0438	121.4438	146.8438	172.2438	197.6438	223.0438	248.4438	273.8438
51/64	0.796875	20.2406	45.6406	71.0406	96.4406	121.8406	147.2406	172.6406	198.0406	223.4406	248.8406	274.2406
13/16	0.8125	20.6375	46.0375	71.4375	96.8375	122.2375	147.6375	173.0375	198.4375	223.8375	249.2375	274.6375
53/64	0.828125	21.0344	46.4344	71.8344	97.2344	122.6344	148.0344	173.4344	198.8344	224.2344	249.6344	275.0344
27/32	0.84375	21.4312	46.8312	72.2312	97.6312	123.0312	148.4312	173.8312	199.2312	224.6312	250.0312	275.4312
55/64	0.859375	21.8281	47.2281	72.6281	98.0281	123.4281	148.8281	174.2281	199.6281	225.0281	250.4281	275.8281
7/8	0.875	22.2250	47.6250	73.0250	98.4250	123.8250	149.2250	174.6250	200.0250	225.4250	250.8250	276.2250
57/64	0.890625	22.6219	48.0219	73.4219	98.8219	124.2219	149.6219	175.0219	200.4219	225.8219	251.2219	276.6219
29/32	0.90625	23.0188	48.4188	73.8188	99.2188	124.6188	150.0188	175.4188	200.8188	226.2188	251.6188	277.0188
59/64	0.921875	23.4156	48.8156	74.2156	99.6156	125.0156	150.4156	175.8156	201.2156	226.6156	252.0156	277.4156
15/16	0.9375	23.8125	49.2125	74.6125	100.0125	125.4125	150.8125	176.2125	201.6125	227.0125	252.4125	277.8125
61/64	0.953125	24.2094	49.6094	75.0094	100.4094	125.8094	151.2094	176.6094	202.0094	227.4094	252.8094	278.2094
31/32	0.96875	24.6062	50.0062	75.4062	100.8062	126.2062	151.6062	177.0062	202.4062	227.8062	253.2062	278.6062
63/64	0.984375	25.0031	50.4031	75.8031	101.2031	126.6031	152.0031	177.4031	202.8031	228.2031	253.6031	279.0031

GLOBAL NETWORK

BEARING BUSINESS OPERATIONS

JTEKT CORPORATION NAGOYA HEAD OFFICE

No.7-1, Meieki 4-chome, Nakamura-ku, Nagoya, Aichi 450-8515,
JAPAN
TEL : 81-52-527-1900
FAX : 81-52-527-1911

JTEKT CORPORATION OSAKA HEAD OFFICE

No.5-8, Minamisemba 3-chome, Chuo-ku, Osaka 542-8502,
JAPAN
TEL : 81-6-6271-8451
FAX : 81-6-6245-7892

Sales & Marketing Headquarters

No.5-8, Minamisemba 3-chome, Chuo-ku, Osaka 542-8502,
JAPAN
TEL : 81-6-6245-6087
FAX : 81-6-6244-9007

OFFICES

KOYO CANADA INC.

5324 South Service Road, Burlington, Ontario L7L 5H5, CANADA
TEL : 1-905-681-1121
FAX : 1-905-681-1392

KOYO CORPORATION OF U.S.A.

-Cleveland Office-

29570 Clemens Road, P.O.Box 45028 Westlake,
OH 44145, U.S.A.
TEL : 1-440-835-1000
FAX : 1-440-835-9347

-Detroit Office-

47771 Halyard Drive, Plymouth, MI 48170, U.S.A.
TEL : 1-734-454-1500
FAX : 1-734-454-4076

KOYO MEXICANA, S.A. DE C.V.

Rio Nazas No.171, 3er piso, Col. Cuauhtemoc, México, D.F. C.P.
06500, MEXICO
TEL : 52-55-5207-3860
FAX : 52-55-5207-3873

KOYO LATIN AMERICA, S.A.

Edificio Banco del Pacifico Planta Baja, Calle Aquilino de la
Guardia y Calle 52, Panama, REPUBLICA DE PANAMA
TEL : 507-208-5900
FAX : 507-264-2782/507-269-7578

KOYO ROLAMENTOS DO BRASIL LTDA.

Rua Desembargador Eliseu Ghilherme 304, 7-Andar, Paraiso,
CEP 04004-30, BRASIL
TEL : 55-11-3887-9173
FAX : 55-11-3887-3039

JTEKT (THAILAND) Co., LTD.

172/1 Moo 12 Tambol Bangwua, Amphur Bangpakong,
Chachoengsao 24180, THAILAND
TEL : 66-38-533-310-7
FAX : 66-38-532-776

KOYO SINGAPORE BEARING (PTE.) LTD.

#09-01, C&P Logistics Hub 2, 27, Penjuru Lane, SINGAPORE,
609195
TEL : 65-6274-2200
FAX : 65-6862-1623

-MIDDLE EAST (BRANCH)-

6EA312, Dubai Airport Free Zone, P.O. Box 54816, Dubai, U.A.E.
TEL : 971-4-2993600
FAX : 971-4-2993700

PHILIPPINE KOYO BEARING CORPORATION

Rm.504, Comfoods Bldg., Cor. Gil Puyat Ave. and
Pasong Tamo, Makati City, PHILIPPINES
TEL : 63-2-817-8881/8901
FAX : 63-2-867-3148

JTEKT KOREA CO., LTD.

Inwoo Building 6F, 539-11, Shinsa-Dong,
Kangnam-Ku, Seoul, KOREA
TEL : 82-2-549-7922
FAX : 82-2-549-7923

JTEKT (CHINA) CO., LTD.

Rm.1906, Aetna Tower, 107 Zunyi Road, Shanghai, 200051,
CHINA
TEL : 86-21-6237-5280
FAX : 86-21-6237-5277

KOYO (SHANGHAI) CO., LTD.

Rm.1905, Aetna Tower, 107 Zunyi Road, Shanghai, 200051,
CHINA
TEL : 86-21-6237-5280
FAX : 86-21-6237-5277

KOYO AUSTRALIA PTY. LTD.

Unit 2, 8 Hill Road, Homebush Bay, NSW 2127, AUSTRALIA
TEL : 61-2-8719-5300
FAX : 61-2-8719-5333

JTEKT EUROPE BEARINGS B.V.

Markerkant 13-01, 1314 AN Almere, THE NETHERLANDS
TEL : 31-36-5383333
FAX : 31-36-5347212

KOYO KULLAGER SCANDINAVIA A.B.

Johanneslundsvägen 4, 194 61 Upplands Väsby, SWEDEN
TEL : 46-8-594-212-10
FAX : 46-8-594-212-29

KOYO (U.K.) LTD.

Whitehall Avenue, Kingston, Milton Keynes MK10 OAX,
UNITED KINGDOM
TEL : 44-1908-289300
FAX : 44-1908-289333

KOYO ROMANIA REPRESENTATIVE OFFICE

Str. Frederic Jolliot-Curie, Nr.3, Etaj 1, Ap.2, Sector 5
Bucharest, ROMANIA
TEL : 40-21-410-4170/4182/0984
FAX : 40-21-410-1178

KOYO DEUTSCHLAND GMBH.

Bargkoppelweg 4, D-22145 Hamburg, GERMANY
TEL : 49-40-67-9090-0
FAX : 49-40-67-9203-0

KOYO FRANCE S.A.

8 Rue Guy Moquet, B.P.189 Z.I., 95105 Argenteuil Cedex, FRANCE
TEL : 33-1-3998-4202
FAX : 33-1-3998-4244/4249

KOYO IBERICA, S.L.

Avda.da la Industria, 52-2 izda 28820
Coslada Madrid, SPAIN
TEL : 34-91-329-0818
FAX : 34-91-747-1194

KOYO ITALIA S.R.L.

Via Bronzino 9, 20133 Milano, ITALY
TEL : 39-02-2951-0844
FAX : 39-02-2951-0954

BEARING PLANTS

KOYO CORPORATION OF U.S.A. (MANUFACTURING DIVISION)

-Orangeburg Plant-

2850 Magnolia Street, Orangeburg, SC 29115, U.S.A.
TEL : 1-803-536-6200
FAX : 1-803-534-0599

-Richland Plant-

1006 Northpoint Blvd., Blythewood, SC 29016, U.S.A.
TEL : 1-803-691-4624/4633
FAX : 1-803-691-4655

JTEKT (THAILAND) Co., LTD.

172/1 Moo 12 Tambol Bangwua, Amphur Bangpakong,
Chachoengsao 24180, THAILAND
TEL : 66-38-531-988/993
FAX : 66-38-531-996

KOYO MANUFACTURING (PHILIPPINES) CORP.

Lima Technology Center, Municipality of Malvar, Batangas
Province, 4233 PHILIPPINES
TEL : 63-43-981-0088
FAX : 63-43-981-0001

KOYO JICO KOREA CO., LTD

28-12, Yulpo-Ri, Koduc-Myun, Pyung Teak-City, Kyungki-Do, KOREA
TEL : 82-31-668-6381
FAX : 82-31-668-6384

KOYO BEARING DALIAN CO., LTD.

No.II A-2 Dalian Export Processing Zone, 116600, CHINA
TEL : 86-411-8731-0972/0974
FAX : 86-411-8731-0973

WUXI KOYO BEARING CO., LTD.

Wuxi Li Yuan Economic Development Zone, Wuxi, 214072,
CHINA
TEL : 86-510-85161901
FAX : 86-510-85161143

DALIAN KOYO WAZHOU AUTOMOBILE BEARING CO., LTD.

No.96, Liaohe East Road, D.D Port, Dalian, 116620, CHINA
TEL : 86-411-8740-7272
FAX : 86-411-8740-7373

KOYO LIOHO (FOSHAN) AUTOMOTIVE PARTS CO., LTD.

No.12, Wusha Section Of Shunpan Road, Daliang Town, Shunde
Of Foshan, Guandong, Province, CHINA
(SHUNDE INDUSTRIAL PARK)
TEL : 86-757-22829589
FAX : 86-757-22829586

KOYO AUTOMOTIVE PARTS (WUXI) CO.,LTD.

B6-A New District, Wuxi, 214028, CHINA
TEL : 86-510-8533-0909
FAX : 86-510-8533-0155

KOYO BEARINGS (EUROPE) LTD.

P.O.Box 101, Elmthirst Lane, Dodworth, Barnsley,
South Yorkshire, S75 3TA, UNITED KINGDOM
TEL : 44-1226-733200
FAX : 44-1226-204029

KOYO ROMANIA S.A.

1, Tr. Magurele Street, 140003 Alexandria, ROMANIA
TEL : 40-24-731-2605
FAX : 40-24-731-5892

TECHNICAL CENTERS

JTEKT CORPORATION NORTH AMERICAN TECHNICAL CENTER

47771 Halyard Drive, Plymouth, MI 48170, U.S.A.
TEL : 1-734-454-1500
FAX : 1-734-454-4076

JTEKT (CHINA) CO., LTD. TECHNICAL CENTER

Rm.1905, Aetna Tower, 107 Zunyi Road, Shanghai, 200051,
CHINA
TEL : 86-21-6237-5280
FAX : 86-21-6237-5277

JTEKT CORPORATION EUROPEAN TECHNICAL CENTRE

Markerkant 13-02, 1314 AN Almere, THE NETHERLANDS
TEL : 31-36-5383350
FAX : 31-36-5302656

Value & Technology



This catalog has been printed on paper of recycled paper pulp using environmentally friendly soy ink.